

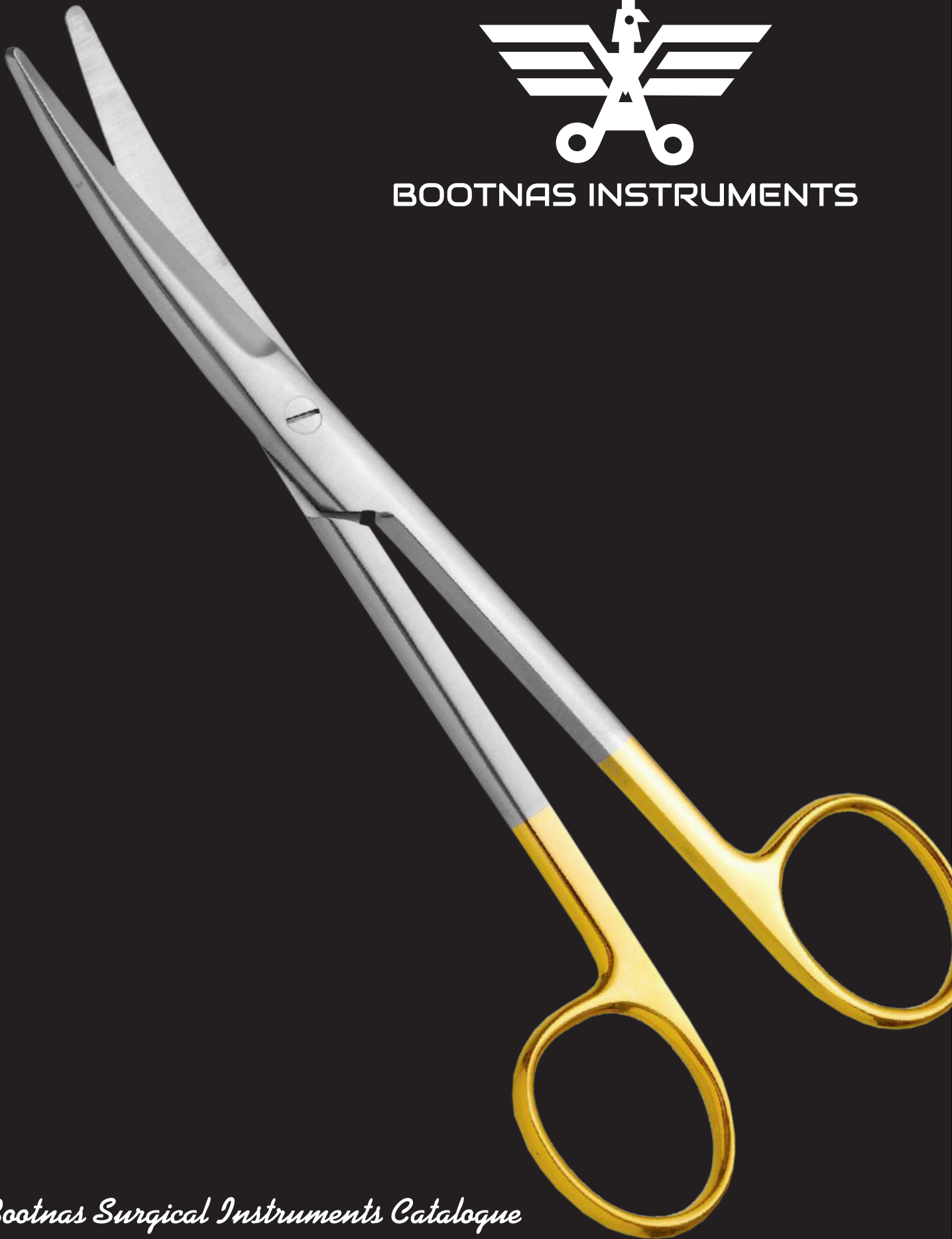

BOOTNAS INSTRUMENTS



*Bootnas Surgical Instruments Catalogue*



## Company Profile

We feel immense pleasure to present our latest catalogues in which we have featured a most comprehensive range of all quality Surgical Instruments required for day to day use for surgeons, operating rooms, nurses central supply, clinics, floor use , emergency rooms, professional and other members of the surgical care team.

(Founder of the company) Mr. Muhammad Boota. without his loyalty, support and steady flow of innovative ideas, we would not be marking this momentous occasion.

Further we are proud to dedicate this landmark edition to you beign our valued customer. With this dedication, we would also like to recognize and honors team past and present. Our responsibility toward the surgeon and the patient as an obligation to continue to focus our skill experience, and creativity on advancing the art of medical technology in the future.

We are following in the footsteps of our founder, Mr. Muhammad Boota in a culture dedicated to quality, Service and responsiveness to our customer's needs. Today's, all of us at Bootnas Instruments is proud to serve as your supplier for the speciality of all kinds of surgical, Dental & Hollow ware products

Bootnas Instruments has ISO 9001 :2000, ISO: 13485 :2003, cGMP Approved and CE Marked. We wear this badge with pride. We have implimented not to our products, but rather to a Company's documented quality politicize, processes and procedures.

Close relationship and cooperation with our customers, surgeons and scientists worldwide guarantees that our products range is permanently updated, expanded and on the edge of technical developments. This allow Bootnas to be the frontrunner for the demands of the world market.

All instruments are manufactured according to the recognized standard patterns currently in use in Hospitals throughout the world and are being produced under the strict control of experts to avoid any flaw and to refrain any complaint at any stage. If there is any way we can be of service to you, please contact us without any hesitation.

We express our thanks to our entire customer for the confidence they have placed in us in the past.

We further assure them, that we will continue our best efforts to gain their confidence in the future.

Thanks & Regard

**Bootnas Instruments**





## Section Index

05:	Diagnostic Instruments
07:	Anesthesia Instruments
09:	Scalpel Blades and Handles
11:	Scissors
12:	Micro Scissors
14:	Dressing and Tissue Forceps
16:	Microsurgery Forceps Atraumatic Bulldog Clamps
18:	Hemostatic Forceps
20:	Towel Clamps
22:	Sponge Dressing Forceps
24:	Retractors
26:	Probes, Cotton Applicators
28:	Trocars
30:	Needle Holders
32:	Suturing Instruments
34:	Sterilization Instruments
36:	Plaster of Paris Instruments
38-39:	Orthopedic Instruments
44:	Neurosurgical Instruments
46-48:	Ophthalmic Instruments
50:	Ear Instruments
52:	Nasal Instruments
54:	Oral Instruments
56:	Tonsil Instruments
58:	Laryngeal Instruments
60:	Tracheal Instruments
62:	Thoracic Instruments
66:	Cardiovascular Instruments
68:	Gall Bladder and Kidney Instruments
72:	Intestinal Instruments
74:	Urological Instruments
76:	Rectal Instruments
78:	Gynecological Instruments
82:	Obstetrical Instruments
86:	Dermal and Podiatry Instruments
90:	Sterilization Containers and Accessories
94:	Suggested Surgical Sets

**Key: Instruments highlighted in yellow denote Tungsten Carbide working ends.**



## IFU - Instrument Care and Cleaning Guidelines

Please follow OSHA/ AORN industry standard care and maintenance guidelines in order to protect your surgical instrument investment. We recommend the use of only stainless steel instruments for surgical procedures. Always process and sterilize new instruments prior to use. Proper care and handling will extend the useful life of your instrument inventory.

1. **Rinse** thoroughly all contaminated instruments after use, to remove blood, tissue, etc. Use PH neutral distilled water and enzymatic cleaner when soaking instruments. Refer to A.A.M.I. Standards and Recommended Practice, "Safe Handling and Biological Decontamination of Medical Devices in Health Care Settings", ANSI/ AAMI ST35:2003.
2. **Inspect** instruments carefully for proper functionality. Remove any instrument in need of repair or replacement. Do not re-use damaged instruments or those beyond their useful life.
3. **Clean** instruments either manually, using a PH neutral detergent and a soft bristle nylon brush (do not use steel wool) or with ultrasonic cleaning, which is a very effective method of debris removal. Always be sure to separate dissimilar metals.
4. **Lubricate** all hinged (screw and box lock) instruments with non-silicone, water based instrument milk.
5. **Autoclave** instruments using AAMI ST79 standards. Pre-vacuum steam, 4 minutes at 132°C/270°F, 20 minutes dry time. Gravity displacement steam, 15 minutes at 132°C/270°F, 15-30 minutes dry time.

Hinged instruments should be sterilized in the open position; protect sharps. Do not cool instruments quickly; follow manufacturer's instructions and never overload the autoclave chamber. Clean regularly.

If staining or discoloration should occur, feel free to contact us for assistance.

6. **Store** instruments carefully in a clean and dry environment. In a procedure tray, place heavy items on the bottom of the sterilization container with more delicate instruments at the top.

**Never immerse Tungsten Carbide instruments in cold sterilization solution. Use instruments only for their intended purpose.**

Contact us for your authorized medical supply distributor if your BOOTNAS brand surgical instruments require repair or refurbishment.

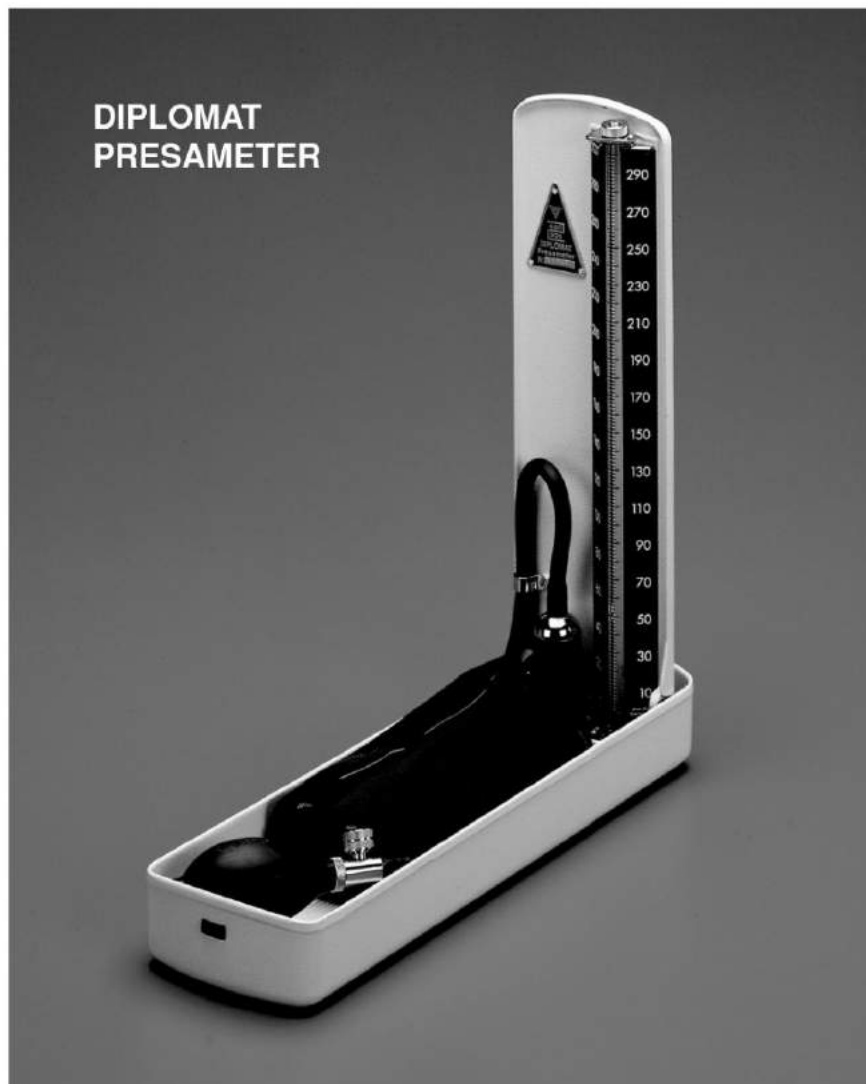

Economical and attractive mercurial sphygmomanometer in metal case. Enamelled in light gray color. Precision glass tube with inside diameter 4,2 mm +/- 0,2 mm. Anodized faceplate with easy to read graduated scale. Maximum reading 300 mmHg. Nickel-plated metal parts. Mercury lock. Maximum error throughout range +/- 3 mmHg. Complete with latex bulb and chrome-plated air-release valve.

**No. 05-112-00 - With cotton bandage cuff complete with 2-tube latex bladder.**

**No. 05-112-01 - With cotton hook cuff complete with 2-tube latex bladder.**

**No. 05-112-02 - With calibrated nylon velcro complete with 2-tube latex bladder.**

Tensiómetro de mercurio económico y de una gran difusión en estuche metálico. Recubierto con plástico de color gris claro. Tubo vidrio de máxima precisión con diámetro interior de 4,2 mm +/- 0,2 mm. Lectura cómoda en la escala anodizada hasta 300 mmHg. Partes metálicas niqueladas. Tiene cierre de seguridad en el depósito de mercurio. Tolerancia de errores máxima del aparato +/- 3 mmHg. Pera latex y válvula cromada.

**No. 05-112-00 - Con brazaletes de venda de algodón, completo, bolsa latex de 2 tubos.**

**No. 05-112-01 - Con brazaletes de ganchos de algodón, completo, con bolsa latex de 2 tubos.**

**No. 05-112-02 - Con brazaletes velcro de nilón, calibrado, completo con bolsa latex de 2 tubos.**

Sfigmomanometro a mercurio economico ed elegante in astuccio di metallo. Verniciato in grigio chiaro. Colonna di precisione di vetro con diametro interno 4,2 mm +/- 2 mm. Quadrante anodizzato con scala graduata di facile lettura. Valore massimo 300 mmHg. Parti metalliche nichelate. Chiusura di sicurezza del mercurio. Tolleranza +/- 3 mmHg. Completo di monopalla in latex e valvola di sfiato cromata.

**No. 05-112-00 - Con bracciale di cotone a fascia, complete di camera d'aria in latex a due tubi.**

**No. 05-112-01 - Con bracciale di cotone a ganci, completo di camera d'aria in latex a due tubi.**

**No. 05-112-02 - Con bracciale calibrato velcro-nylon completo di camera d'aria in latex a due tubi.**



## Sphygmomanometer Esfigmomanómetros

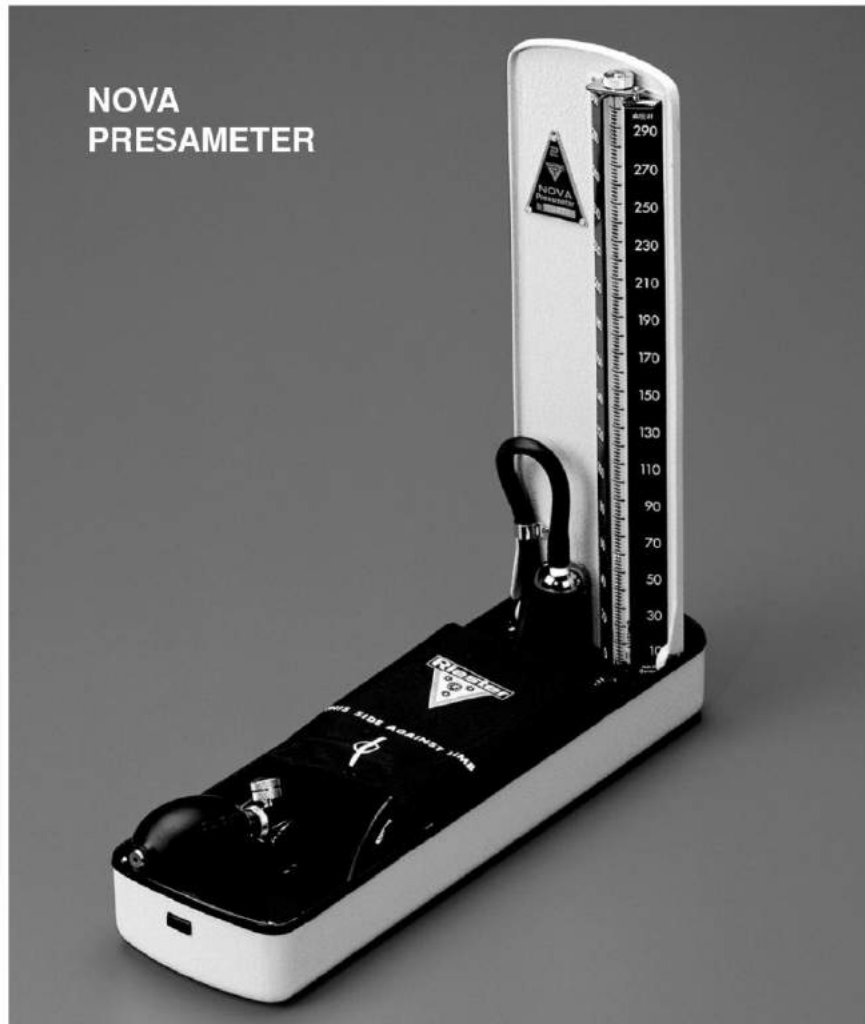

High quality extra sturdy mercurial sphygmomanometer in metal case. Enameled in light gray with contrasting trim. Precision glass tube with inside diameter 4,2 mm +/- 0,2 mm. Anodized faceplate with easy to read graduated scale. Maximum reading 300 mmHg. Chrome-plated metal parts. Mercury lock. Bulb holder. Maximum error throughout range +/- 3 mmHg. With latex bulb and chrome-plated air release valve.  
**No. 05-113-00 - With cotton bandage cuff complete with 2-tube latex bladder.**  
**No. 05-113-01 - With cotton hook cuff complete with 2-tube latex bladder.**  
**No. 05-113-02 - With calibrated nylon velcro complete with 2-tube latex bladder.**

Tensiómetro de mercurio de alta calidad en estuche metálico barnizado al fuego en gris claro y negro. Tubo vidrio de precisión máxima con diámetro interior de 4,2 mm +/- 0,2 mm. Cómoda lectura de la escala anodizada hasta 300 mmHg. Partes metálicas cromadas. El depósito de mercurio lleva un cierre de seguridad. Soporte para pera. Tolerancia de errores máxima del aparato +/- 3 mmHg. Con pera latex y válvula cromada.  
**No. 05-113-00 - Con brazalete de venda de algodón completo, con bolsa latex con 2-tubos.**  
**No. 05-113-01 - Con brazalete de ganchos de algodón completo, con bolsa latex con 2-tubos.**  
**No. 05-113-02 - Con brazalete velcro de nilón calibrado completo, con bolsa latex con 2-tubos.**

Sfigmomanometro a mercurio di alta qualità, molto robusto, in astuccio di metallo, verniciato in grigio chiaro con eleganti rifiniture. Colonna di precisione di vetro con diametro interno 4,2 mm +/- 2 mm. Quadrante anodizzato con scala graduata di facile lettura. Valore massimo 300 mmHg. Parti metalliche cromate. Chiusura di sicurezza del mercurio. Supporto per monopalla. Tolleranza +/- 3 mmHg. Con monopalla in latex e valvola di sfiato cromata.  
**No. 05-113-00 - Con bracciale di cotone a fascia completo di camera d'aria di latex a 2-tubi.**  
**No. 05-113-01 - Con bracciale di cotone a ganci completo di camera d'aria di latex a 2-tubi.**  
**No. 05-113-02 - Con bracciale calibrato velcro-nylon completo di camera d'aria di latex a 2-tubi.**

**NOVA  
WALLMODEL**

High quality mercurial sphygmomanometer ideal for use in hospitals and physicians offices. Non-swiveling metal housing enameled in light gray. Precision glass tube with inside diameter 4,2 mm +/- 0,2 mm. Anodized faceplate with easy to read graduated scale. Maximum reading 300 mmHg. Chrome-plated metal parts. Mercury lock. Plastic coated metal basket for convenient accessory storage. Coiled tubing extensible to 9 feet. Maximum error throughout range +/- 3 mmHg. With latex bulb and chrome-plated air release valve. Mounting hardware included.

- No. 05-114-00 - With cotton bandage cuff complete with 2-tube latex bladder.**
- No. 05-114-01 - With cotton hook cuff complete with 2-tube latex bladder.**
- No. 05-114-02 - With calibrated nylon velcro cuff complete with 2-tube latex bladder.**

Tensiómetro de mercurio de alta calidad y fiabilidad, ideal para consultorios y clínicas. Fijo, no movable. Placa metal recubierta plástico de color gris claro. Tubo vidrio de precisión máxima y diámetro interior de 4,2 mm +/- 0,2 mm. Cómoda lectura de la escala anodizada hasta 300 mmHg. Partes metálicas cromadas. Con cierre de seguridad en el depósito de mercurio. Cestillo metálico recubierto de plástico para la colocación del accesorio. Con tubo espiral extensible hasta 3 metros. Tolerancia de errores máxima del aparato: +/- 3 mmHg. Con pera latex y válvula cromada. Se incluyen tacos y tornillos para la sujeción.

- No. 05-114-00 - Con brazaletes de venda de algodón completo con bolsa latex con 2 tubos.**
- No. 05-114-01 - Con brazaletes de ganchos de algodón completo con bolsa latex con 2 tubos.**
- No. 05-114-02 - Con brazaletes velcro de nilón calibrado completo con bolsa latex con 2 tubos.**



Sfigmomanometro a mercurio di alta qualità, ideale per ospedali ed ambulatori. Corpo dell'apparecchio in metallo, non orientabile, verniciato in grigio chiaro. Colonna di precisione di vetro con diametro interno 4,2 mm +/- 0,2 mm. Quadrante anodizzato con scala graduata di facile lettura. Valore massimo 300 mmHg. Parti metalliche cromate. Chiusura di sicurezza del mercurio. Cestello porta accessori in metallo rivestito di plastica. Tubo a spirale estensibile fino a 3 m. Tolleranza +/- 3 mmHg. Con monopalla in latex e valvola di sfiato cromata. Fornito con accessori di montaggio.

- No. 05-114-00 - Con bracciale di cotone a fascia completo di camera d'aria di latex a 2-tubi.**
- No. 05-114-01 - Con bracciale di cotone a ganci completo di camera d'aria di latex a 2-tubi.**
- No. 05-114-02 - Con bracciale calibrato velcro-nylon completo di camera d'aria di latex a 2-tubi.**



Sphygmomanometer  
Esfigmomanómetros



Latest version of our well-known Exacta classic sphygmomanometer, with an especially attractive price. Metal housing with baked on black enamel finish. Special tempered copper beryllium diaphragm. No stop pin. Easy-to-read graduated aluminium scale 49 mm  $\phi$ . Maximum reading 300 mmHg. Clip on rear of manometer for attachment to cuff. With latex bulb and chrome-plated air release valve, in vinyl zipper case. Maximum error  $\pm$  3 mmHg throughout range.

**No. 05-120-00 - With calibrated nylon-velcro cuff complete with 2-tube latex bladder.**

Modelo más moderno que nuestro anterior Exacta manómetro muy popular y conocido. Con precio muy económico. Caja metálica barnizada al fuego de color negro. Con membrana cobreberilio endurecido especial. Sin fijación a cero. Buena lectura de la escala aluminio  $\phi$  49 mm hasta 300 mmHg. Con pinza metálica a la parte posterior del manómetro para ganchar en el brazalete. Con pera de latex y válvula cromada. En estuche de vinyl con cierre de cremallera. Tolerancia de errores máxima del aparato:  $\pm$  3 mmHg.

**No. 05-120-00 - Con brazalete velcro de nilón calibrado completo con bolsa de latex con 2 tubos.**

La più recente versione dei famosi sfigmomanometri tradizionali Exacta, ad un prezzo veramente interessante. Realizzato in metallo rifinitura smaltata a forno. Membrana speciale di rame-berillio indurito. Senza fissaggio a zero. Scala graduata in alluminio  $\phi$  49 mm di facile lettura. Valore massimo 300 mmHg. Con morsetto nella parte posteriore del manometro per l'attacco al bracciale. Monopalla di latex e valvola di sfiato cromata. Fornito in borsa di vinilpelle con cerniera lampo. Tolleranza  $\pm$  3 mmHg.

**No. 05-120-00 - Con bracciale calibrato velcro-nylon completo di camera d'aria di latex a 2 tubi.**



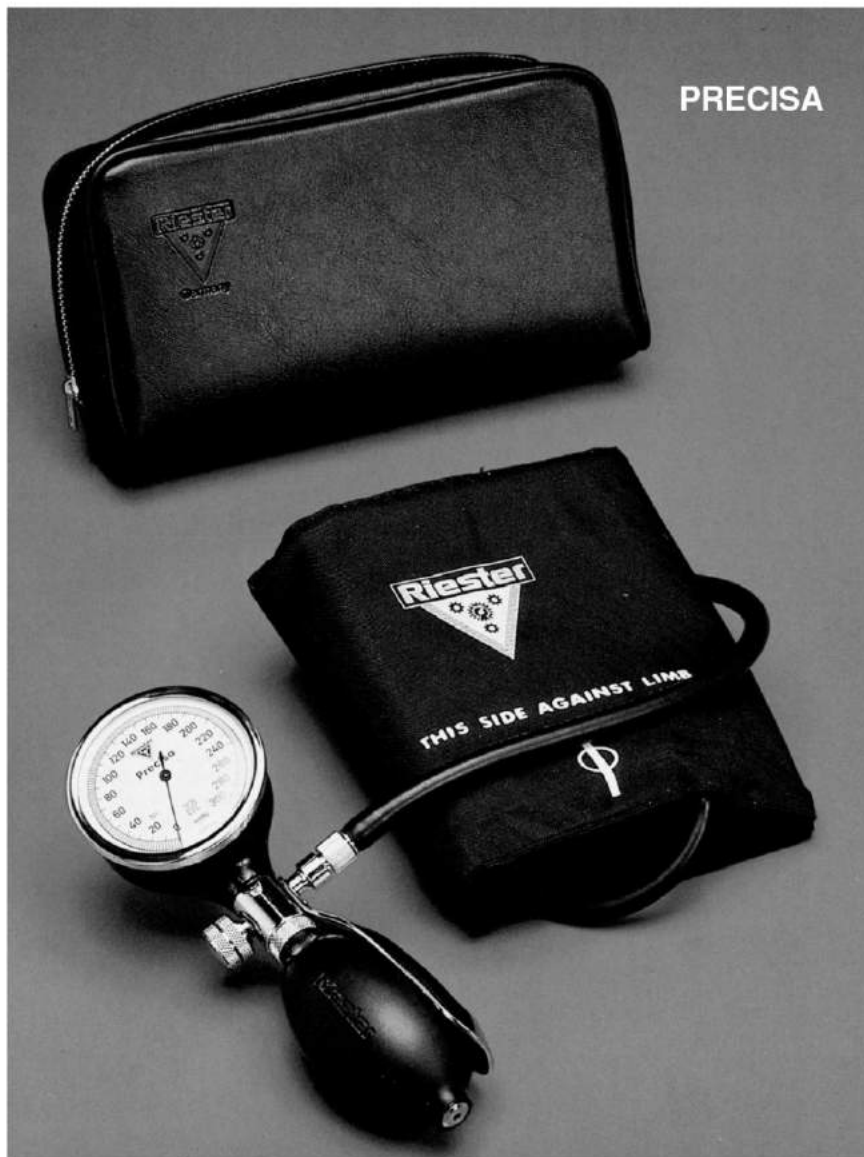

Very attractive and economical modern palm-style sphygmomanometer. Black housing of engineering plastic with chrome-plated tube connection at lower right. Special tempered copper beryllium diaphragm. No stop pin. Easy-to-read graduated aluminium scale  $\varnothing$  63 mm. Maximum reading 300 mmHg. Stainless steel handle. With latex bulb and chrome-plated air release valve, in vinyl zipper case. Maximum error  $\pm$  3 mmHg throughout range.

**No. 05-122-00 - With calibrated nylon-velcro cuff complete with 1-tube latex bladder.**

Modelo de mano, muy económico, moderno y popular. Estuche plástico duro de color negro. Con membrana cobre-berilio endurecido especial. Sin fijación a cero. Buena lectura de la escala de aluminio  $\varnothing$  63 mm hasta 300 mmHg. Con cuchara de acero inoxidable. Con pera de latex y válvula cromada. Con atornilladura de tubo cromada al lado derecho debajo del manómetro. En estuche de vinilo con cierre de cremallera. Tolerancia de errores máxima del aparato:  $\pm$  3 mmHg.

**No. 05-122-00 - Con brazalete velcro de nilón, calibrado, completo con bolsa de latex con 1 tubo.**

Sfigmomanometro molto elegante, moderno ed economico. Modello a mano. Scatola del manometro in materiale sintetico robusto con uscita laterale cromata per collegamento del tubo (in basso a destra). Membrana speciale in rame-berillio indurito. Senza fissaggio a zero. Scala graduata in alluminio di facile lettura,  $\varnothing$  63 mm. Valore massimo 300 mmHg. Manico in acciaio inossidabile. Con monopalla di latex, valvola di sfiato cromata. Fornito in borsa di vinilpelle con chiusura lampo. Tolleranza  $\pm$  3 mmHg.

**No. 05-122-00 - Con bracciale calibrato velcro-nylon completo di camera d'aria di latex add 1 tubo.**



## Sphygmomanometer Esfigmomanómetros



Modern palm model sphygmomanometer specially designed for pediatric use. Interchangeable cuffs equipped with metal tube connectors for quick and reliable attachment to unit of cuff appropriate to age of patient. Scale, bulb, cuffs, and case in attractive light blue color, with cuffs printed with child-friendly bear motif. Chrome-plated metal housing with tube connection at top. Stainless steel handle. Special tempered copper-beryllium diaphragm. No stop pin. Easy-to-read graduated manometer scale  $\varnothing$  49 mm. Maximum reading 300 mmHg. With soft plastic bulb, chrome-plated air-release valve, and set of three interchangeable cuffs, in leatherette zipper case. Maximum error  $\pm$  3 mmHg throughout range.

**No. 05-126-00 - Complete with set of three interchangeable cuffs with metal connectors.**  
Newborn: 15,5 x 5,0 cm - Infant: 23,0 x 7,2 cm - Child: 35,5 x 10,0 cm

Tensiómetro a mano, apropiado especialmente p. consultorios de pediatra. Se fabrica en color azul, agradable p. niños. Estuche metálico cromado. Membrana cobre-berilio endurecido especial. Sin fijación a cero. Buena lectura de la escala aluminio de colores azul y blanco  $\varnothing$  49 mm hasta 300 mmHg. Cuchara de acero inoxidable. Pera de hule de plástico suave azul. Válvula cromada. Atornilladura de tubo cromada a la parte superior del manómetro. En estuche de cuero artificial, azul. c. cierre de cremallera. Tolerancia de errores máxima:  $\pm$  3 mmHg. 3 brazaletes velcro de nilón, calibrados, con bolsas latex, 1 tubo de tamanos diferentes de color azul. Los tres brazaletes llevan impreso unos osos especialmente atractivo p. niños.

**No. 05-126-00 - Juego, completo con 3 brazaletes intercambiados con conectores metálicos.**  
Recien nacidos: 15,5 x 5,0 cm - Lactantes: 23,0 x 7,2 cm - Niños: 35,5 x 10,0 cm

Sfigmomanometro moderno, modello a mano, per uso pediatrico. Bracciali intercambiabili corredati di connettori di metallo per un veloce e sicuro attacco all'apparecchio del bracciale più adatto all'età del paziente. Scala graduata, monopalla, bracciali e astuccio di colore azzurro. Bracciali con stampato motivo adatto per bambini. Manometro cromato con uscita per collegamento tubo nella parte superiore. Manico in acciaio inossidabile. Membrana speciale in rame-berillio indurito. Senza fissaggio a zero. Scala graduata del manometro  $\varnothing$  49 mm di facile lettura. Valore massimo 300 mmHg. Monopalla in plastica morbido, valvola di sfiato cromata e set di 3 bracciali intercambiabili in astuccio di finta pella con cerniera lampo. Tolleranza  $\pm$  3 mmHg.

**Nr. 05-126-00 - Comprende set di 3 bracciali intercambiabili con raccordi di metallo.**  
Neonati: 15,5 x 5,0 cm - Bambini piccoli: 23,0 x 7,2 cm - Bambini: 35,5 x 10,0 cm



World-famous palm-style aneroid sphygmomanometer. Chrome-plated metal housing. Special tempered copper beryllium diaphragm. No stop pin. Easy-to-read graduated aluminum scale 49 mm  $\phi$ . Maximum reading 300 mmHg. Stainless steel handle. With latex bulb and chrome-plated air release valve. In vinyl zipper case. Maximum error  $\pm$  3 mmHg throughout range.

- No. 05-132-00 - With cotton bandage cuff, complete with 1-tube latex bladder.**
- No. 05-132-01 - With cotton hook cuff, complete with 1-tube latex bladder.**
- No. 05-132-02 - With calibrated nylon-velcro cuff, complete with 1-tube latex bladder.**

Modelo de mano, de fama mundial y preferido por los medicos. Caja metálica cromada donde se aloja el mecanismo. Con membrana cobreberilio endurecido especial. Sin fijación a cero. Buena lectura de la escala de aluminio  $\phi$  49 mm hasta 300 mmHg. Con cuchara de acero inoxidable. Con pera latex y válvula cromada. Con atornilladura de tubo cromada a la parte superior del manómetro. En estuche de vinilico con cierre de cremallera. Tolerancia máxima del aparato:  $\pm$  3 mmHg.

- No. 05-132-00 - Con brazalete de venda de algodón completo con bolsa de latex con 2 tubos.**
- No. 05-132-01 - Con brazalete de ganchos de algodón completo con bolsa de latex con 2 tubos.**
- No. 05-132-02 - Con brazalete velcro de nilón calibrado completo con bolsa de latex con 2 tubos.**

Sfigmomanometro ad aneroide, modello a mano di fama mondiale. Manometro cromato con uscita per collegamento tubo cromata, nella parte superiore. Membrana speciale di rame-berillio indurito. Senza fissaggio a zero. Scala graduata in alluminio  $\phi$  49 mm di facile lettura. Valore massimo 300 mmHg. Manico in acciaio inossidabile. Con monopalla di latex e valvola di sfiato cromato. Fornito in borsa vinilpelle con cerniera lampo. Tolleranza  $\pm$  3 mmHg.

- No. 05-132-00 - Con bracciale di cotone a fascia completo di camera d'aria latex ad 1 tubo.**
- No. 05-132-01 - Con bracciale di cotone a ganci completo di camera d'aria di latex ad 1 tubo.**
- No. 05-132-02 - Con bracciale calibrato velcro-nylon completo di camera d'aria di latex ad 1 tubo.**



## Sphygmomanometer Esfigmomanómetros



**MINIMUS III**

World famous and popular palm style sphygmomanometer. Chrome plated metal housing with 2 chromed-tube connections at lower right. Special tempered copper beryllium diaphragm. No stop pin. Easy-to-read graduated aluminium scale  $\varnothing$  49 mm. Maximum reading 300 mmHg. Stainless steel handle. With latex bulb and chrome-plated air release valve. In vinyl zipper case. Maximum error  $\pm$  3 mmHg throughout range.

- No. 05-133-00 - With cotton bandage cuff, complete with double-tube latex bladder.**
- No. 05-133-01 - With cotton hook cuff, complete with double-tube latex bladder.**
- No. 05-133-02 - With calibrated nylon velcro cuff complete with double-tube latex bladder.**

Modelo de mano, conocido en el mundo entero y de gran aceptación. Caja metálica cromada donde se aloja el mecanismo. Membrana cobre-berilio endurecido especial. Sin fijación a cero. Buena lectura de la escala aluminio  $\varnothing$  49 mm hasta 300 mmHg. Cuchara de acero inoxidable. Pera latex y válvula cromada. Dos atornilladuras de tubo cromadas al lado derecho debajo del manómetro. En estuche vinílico con cierre de cremallera. Tolerancia de errores máxima:  $\pm$  3 mmHg.

- No. 05-133-00 - Con brazalete de venda de algodón, completo con bolsa de latex doble tubos.**
- No. 05-133-01 - Con brazalete de ganchos de algodón, completo con bolsa de latex doble tubos.**
- No. 05-133-02 - Con brazalete velcro de nilón calibrado, completo con bolsa de latex doble tubos.**

Sfigmomanometro ad aneroidi di fama mondiale. Manometro in metallo cromato con uscita cromata laterale (in basso a destra) per collegamento a due tubi. Membrana speciale di rame-berillio indurito. Senza fissaggio a zero. Scala graduata in alluminio  $\varnothing$  49 mm di facile lettura. Valore massimo 300 mmHg. Manico in acciaio inossidabile. Con monopalla di latex e valvola di sfiato cromata. Fornito in borsa vinilpelle con cerniera lampo. Tolleranza  $\pm$  3 mmHg.

- No. 05-133-00 - Con bracciale di cotone a fascia, completo di camera d'aria di latex a 2 tubi.**
- No. 05-133-01 - Con bracciale di cotone a ganci, completo di camera d'aria di latex a 2 tubi.**
- No. 05-133-02 - Con bracciale calibrato velcro-nylon completo di camera d'aria a 2 tubi.**

Diagnostic Sets with Standard Illumination  
Estuches de diagnóstico con iluminación standard



**No. 05-161-00**

World famous otoscope set at a budget price for physicians and students. 2,5 V standard illumination for use with 2 batteries type C.  
Set includes: **Otoscope head** with pin contact fitting. Chrome-plated. Fixed protective lens in plastic mount may be removed for introduction of instruments. Plastic connector for pneumatic otoscopy. Removable swivel mounted 4 x magnifier. 2, 3 and 4 mm reusable specula included. **Battery handle 28 mm ø** for 2 C-cell batteries. Chrome plated. With thumb wheel for securing pin contact heads. With rheostat for adjustment of illumination. Complete in silver-colored plastic pouch.

**No. 05-161-00**

Otoscopio muy popular y económico con iluminación standard 2,5 V apropiado para estudiantes y médicos, de fama mundial.  
**Cabeza otoscopio cromada**, con cierre de tornillo. **Mango a pilas cromado 28 mm ø** para dos pilas tipo C. Con cristal de cubierto desmontable en armadura plástica. Con conector plástico para el test neumático. La lente giratoria es desmontable y amplifica 4,0 veces mas. La intensidad de la luz es regulable con el reostato. Con tres espejuelos reutilizables 2, 3 y 4 mm ø. Completo en bolsa de plástico de color gris plata.

**No. 05-161-00**

Combinazione otoscopio molto conosciuta, ad un prezzo economico, per ambulatori e studenti. Illuminazione standard 2,5 V con 2 batterie tipo C.

La combinazione comprende: **Testa otoscopio** con chiusura a vite. Cromata. La lente di protezione fissa in supporto di plastica può essere tolta per l'inserimento di strumenti. Connettore di plastica per test pneumatico. Lente d'ingrandimento 4 x in montatura girevole estraibile. Inclusi specoli riutilizzabili da 2, 3 e 4 mm. **Manico a pila ø 28 mm** per 2 batterie tipo C. Cromato. Con ruota ad orlo zigrinato per fissare la testa dell'otoscopio con chiusura a vite. Con reostato per la regolazione dell'illuminazione. Fornito in busta di plastica colore grigio argento.



## Diagnostic Sets with Standard Illumination Estuches de diagnóstico con iluminación standard



### No. 05-161-01

World famous ophthalmoscope set at a budget price for physicians and students. 2.5 V standard illumination for use with 2 batteries Type C. Set includes: **MAY ophthalmoscope head:** Pin contact fitting. Lens selection wheel permits choice of corrective lenses from 0 to +20 and 0 to -20 diopters. Single large circle aperture. **Battery handle:** 28 mm  $\varnothing$  for 2 C-cell batteries. Chrome-plated. With thumb wheel for securing pin-contact heads. Rheostat for adjustment of illumination. Complete in silver-gray plastic pouch.

### No. 05-161-01

**Ofthalmoscopio May:** muy popular y económico con iluminación standard 2,5 V, apropiado para estudiantes y médicos de fama mundial. Oftalmoscopio con cierre de tornillo. Con ayuda de la rueda de lentes se puede elegir lentes de corrección de 0 a +20 y o a -20 dioptrías. Y con una apertura: gran círculo. Con **mango a pilas:** cromado 28 mm  $\varnothing$  para dos pilas tipo C. La intensidad de la luz es regulable con el reostato. Completo en bolsa de plástico de color gris plata.

### No. 05-161-01

Combinazione oftalmoscopio molto conosciuta, a prezzo economico, per ambulatori e studenti. Illuminazione standard 2,5 V con 2 batterie tipo C. La combinazione comprende: **Ofthalmoscopio di May:** Con chiusura a vite. La rotella di selezione delle lenti permette la scelta di lenti di correzione da 0 a +20 e da 0 a -20 diottrie. Apertura singola a cerchio grande. **Manico a pila:**  $\varnothing$  28 mm per 2 batterie tipo C. Cromato. Con ruota ad orlo zigrinato per fissare la testa dell'otoscopio con chiusura a vite. Reostato per la regolazione dell'illuminazione. Fornito con busta di plastica di colore grigio argento.

Diagnostic Sets with Standard Illumination  
Estuches de diagnóstico con iluminación standard



**No. 05-161-02**

World famous otoscope/ophthalmoscope diagnostic set at a budget price for physicians and students. 2.5 V Standard illumination for use with 2 batteries type C. Set includes: **Otoscope head** - Pin contact fitting. Chrome plated. Fixed protective lens in plastic mount may be removed for introduction of instruments. Plastic connector for pneumatic otoscopy. Removable swivel-mounted 4 x magnifier. 2, 3 and 4 mm reusable specula included. **MAY ophthalmoscope head**. Pin contact fitting. Lens selection wheel permits choice of corrective lenses from 0 to +20 and 0 to -20 diopters. Single large circle aperture. **Battery handle**. 28 mm  $\varnothing$  for 2 C-cell batteries. Chrome-plated. With thumb wheel for securing pin-contact heads. Rheostat for adjustment of illumination.

**No. 05-161-02**

Este estuche de diagnóstico con iluminación standard 2,5 V es muy popular y muy económico, apropiado para estudiantes y médicos. Juego, compuesto de: **Cabeza otoscopio** cromado, con cierre de tornillo. Con cristal de cubierto en armadura plástica, con conector plástico para el test neumático. Con lente giratorio desmontable (amplificación: 4 veces más). **Cabeza oftalmoscopio May** con cierre de tornillo. Con ayuda de la rueda de lentes se puede elegir lentes de corrección de 0 a +20 y 0 a -20 dioptrías. Con una apertura: gran círculo. **Mango a pilas** cromado, 28 mm  $\varnothing$  para dos pilas tipo C. La intensidad de la luz es regulable con el reostato al tope del mango. Todos los partes se presentan en una bolsa plástica de color gris plata.

**No. 05-161-02**

Combinazione per diagnostica otoscopio/oftalmoscopio a prezzo economico, per ambulatori e studenti. Illuminazione standard 2,5 V con 2 batterie tipo C. La combinazione comprende: **Testa otoscopio** - Chiusura a vite. Cromata. La lente di protezione fissa in supporto di plastica può essere tolta per l'inserimento di strumenti. Connettore di plastica per test pneumatico. Lente d'ingrandimento 4 x in montatura girevole estraibile. Inclusi specchi da 2, 3 e 4 mm riusabili. **Oftalmoscopio May**. Chiusura a vite. La rotella di selezione permette la scelta di lenti di correzione da 0 a +20 e da 0 a -20 diottrie. Apertura singola a cerchio grande. **Manico a pila**  $\varnothing$  28 mm con 2 batterie tipo C. Cromato. Con ruota ad orlo zigrinato per fissare la testa dell'otoscopio con chiusura a vite. Reostato per la regolazione dell'illuminazione. Fornita in busta di plastica colore grigio argento.



Diagnostic Sets with Standard Illumination  
Estuches de diagnóstico con iluminación standard



#### No. 05-161-03

World famous very complete diagnostic set at a budget price for physicians and students. 2,5 V standard illumination for use with 2 batteries type C. Including: **Otoscope head:** Pin contact fitting. Chrome-plated. Fixed protective lens in plastic mount may be removed for introduction of instruments. Plastic connector for pneumatic otoscopy. Removable swivel-mounted 4x magnifier: 2, 3 and 4 mm reusable specula included. **MAY ophthalmoscope head:** Pin contact fitting. Lens selection wheel permits choice of corrective lenses from 0 to +20 and 0 to -20 diopters. Single large circle aperture. **Bent-arm illuminator:** Pin contact fitting. Chrome plated. **Tongue blade holder:** Chrome plated. **Nasal speculum:** Chrome plated. **Two laryngeal mirrors:** No. 3 and 4. **Battery handle:** 28 mm  $\phi$  for 2 C-cell batteries. Chrome plated. Rheostat for adjustment of illumination. **Replacement bulb:** 2,5 V. In black plastic storage case.

#### No. 05-161-03

Juego de diagnóstico muy popular y económico con iluminación standard 2,5 V, compuesto de: **Cabeza otoscopio:** con cierre de tornillo. Con cristal de cubierto en armadura plástica, con conector para el test neumático. Con lente giratoria desmontable (amplificación: 4 veces más). Con tres espejuelos reutilizables 2, 3 y 4 mm  $\phi$ . **Cabeza oftalmoscopio May:** con cierre de tornillo. Con ayuda de la rueda de lentes se puede elegir lentes de corrección de 0 a +20 y a -20 dioptrías. Con una apertura: gran círculo. **Especulo nasal:** cromado. **Porta-lámpara:** con una bombilla 2,5 V. Cromada. **Espejo laringeo:** Dos espejos laringeos No. 3 y 4. **Porta abaja-lengua:** Cromada. **Mango a pilas:** cromado. 28 mm  $\phi$  para dos pilas tipo C. **Bombilla de repuesto:** 2,5 V. Todos los pilas se presentan en una estuche plástico negro.

#### No. 05-161-03

Combinazione per diagnostica di alta qualità a prezzo economico per ambulatori e studenti. Illuminazione standard 2,5 V con 2 batterie tipo C. La combinazione comprende: **Testa otoscopio:** Chiusura a vite. Cromata. La lente di protezione fissa in supporto di plastica può essere tolta per l'inserimento di strumenti. Connettore di plastica per test pneumatico. Lente d'ingrandimento 4x in montatura girevole estraibile. Inclusi specoli da 2, 3 e 4 mm riusabili. **Oftalmoscopio di May:** chiusura a vite. Lenti di correzione da 0 a +20 e da 0 a -20 diottrie. Apertura singola a cerchio grande. **Illuminatore a squadra:** Chiusura a vite. Cromato. **Porta abbassa-lingua:** Cromato. **Specolo nasale:** Cromato. **Due specchietti laringei:** Misura 3 e 4. **Manico a pila**  $\phi$  28 mm per 2 batterie tipo C. Cromato. Reostato per la regolazione dell'illuminazione. **Lampadina di ricambio** 2,5 V. Fornita in astuccio di plastica nera.



Diagnostic Sets with Halogen Illumination  
Estuches de diagnóstico con iluminación halógena



Economically priced state-of-the-art quality instrument made of plastics, gray color, with halogen illumination 2,5 V. Due to its small size it is most suitable for each practitioner's bag. **Otoscope:** Fiber optic. Screw type fitting. 2,5 x magnifying glass. Battery handle for 2 AA-cell batteries. **Ophthalmoscope:** Corrective lenses ranging from 0 to +20 and 0 to -20 diopters. Apertures: large and small circle, semi-circle, fixation star and green filter. Otoscope and otoscope/ophthalmoscope set each contain a metal connector for pneumatic otoscopy as well as plastic tube with 5 each reusable ear specula 2,5 and 4,0 mm. All sets come in modern black plastic case.

**No. 05-171-00 - Otoscope with AA-handle.**

**No. 05-171-01 - Ophthalmoscope with AA-handle.**

**No. 05-171-02 - Otoscope/ophthalmoscope with 1 each AA-handle.**

Instrumentos de calidad, muy moderno y pequeño de plástico resistente, gris, con iluminación halógena 2,5 V. Muy económico y gracias al tamaño apropiado para el bolsillo del médico. Cierre roscado. **Otoscopio:** fibra óptica. Conexión para test neumático. Lupa aumenta 2,5 veces más. Mango a pilas para 2 pilas, tipo AA. **Oftalmoscopio:** Lentes de corrección: 0 hasta +20 y 0 hasta -20 dioptrías. Aberturas: círculo grande y pequeño, semicírculo, estrella fijadora y filtro verde. Con mango para 2 pilas, tipo AA. Juego de otoscopio y de otoscopio/oftalmoscopio con conector metálico para el test neumático y con 5 espéculos reutilizables de 2,5 y 4,0 mm en tubito de plástico. Todos los juegos se presentan en estuche de plástico negro moderno.

**No. 05-171-00 - Otoscopio con mango AA.**

**No. 05-171-01 - Oftalmoscopio con mango AA.**

**No. 05-171-02 - Oto/oftalmoscopio con mangos AA.**

Strumento piccolo, moderno, di alta qualità realizzato in plastica, grigio, con illuminazione alogena 2,5 V. Molto economico e, date le sue dimensioni, il più adatto a stare nella borsa del medico. **Otoscopio:** con attacco a vite. Lente d'ingrandimento 2,5X. Manico a pila per 2 batterie tipo AA. **Oftalmoscopio:** Lenti correttive da 0 a +20 e da 0 a -20 diottrie. Aperture: a cerchio grande e piccolo, semicerchio, a stella, filtro verde. Con manico per 2 batterie tipo AA. L'otoscopio e la combinazione otoscopio/oftalmoscopio hanno un connettore per test pneumatico e tubo di plastica con 5 specoli auricolari 2,5 e 4,0 mm. cad. Tutte le combinazioni sono fornite in un moderno astuccio di plastica nera.

**No. 05-171-00 - Otoscopio con manico AA.**

**No. 05-171-01 - Oftalmoscopio con manico AA.**

**No. 05-171-02 - Oto/Oftalmoscopio con manici AA.**



## Diagnostic Sets with Halogen Illumination Estuches de diagnóstico con iluminación halógena

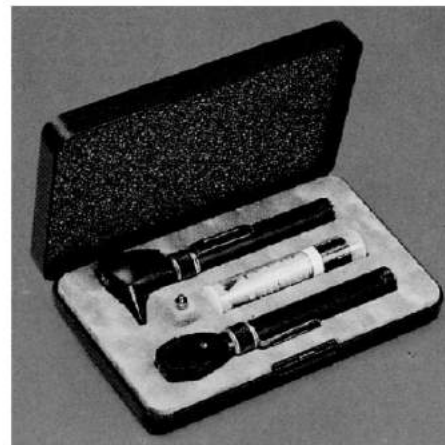
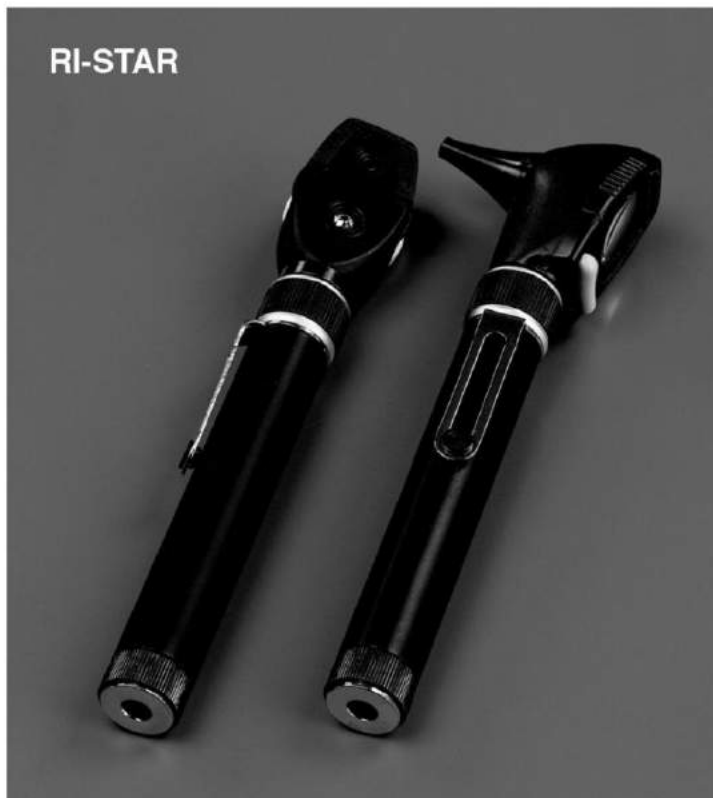

State-of-the-art diagnostic instruments for E.N.T. use with fiber optic and halogen illumination 2,5 V. Instrument heads made of robust plastic. **Otoscope:** Screw type fitting. 2,5 x swivel magnifying lens. Connection for pneumatic otoscopy. Specula ejector. **Ophthalmoscope:** Corrective lenses ranging from -20 to +40 diopters. Apertures: large circle, semi-circle slit, fixation star, green filter. Metal handle for either 2 AA size batteries or 1 Ri-Accu (rechargeable battery) for charging in our charging base, Ri-Charger. All sets including the Ri-Star otoscope are supplied with metal connector for pneumatic otoscopy as well as with plastic tube containing 4 reusable ear specula 2, 3, 4 and 5 mm black and 5 each disposable specula 2,5 and 4 mm gray. Each set comes in modern black plastic case.

**No. 05-172-00 - Otoscope with AA-handle.** **No. 05-172-03 - Otoscope/Ophthalmoscope, 2 Ri-Accu + Ri-Charger 220 V.**  
**No. 05-172-01 - Ophthalmoscope with AA-handle.** **No. 05-172-04 - Otoscope/Ophthalmoscope, 2 Ri-Accu + Ri-Charger 110 V.**  
**No. 05-172-02 - Otoscope/Ophthalmoscope with each AA-handle.**

Instrumentos de diagnóstico muy modernos con fibra óptica e iluminación halógena 2,5 V. Cabezas de instrumentos de plástico resistente. Cierre roscado. **Otoscopio:** Lente giratoria aumenta 2,5 veces más. Conexión para test neumático. Expulsor para espéculos usados. **Oftalmoscopio:** Lentes de corrección: -20 hasta +40 dioptrías. Aperturas: Círculo grande, semicírculo, en forma ranura, estrella fijadora, filtro verde. Mango a pilas para dos pilas, tipo AA, o un Ri-Accu (pila recargable) para recargar en el recargador Ri-Charger. Todos los juegos que incluyen el otoscopio Ri-Star, se sirven con un conector metálico para el test neumático y un tubo de plástico con espéculos reutilizables 2, 3, 4 y 5 mm negro, y 5 espéculos desechables de 2,5 y 4,0 mm, gris. Cada juego se presenta en estuche de plástico negro moderno.

**No. 05-172-00 - Otoscopio con mango-AA.** **No. 05-172-03 - Otoscopio/Oftalmoscopio, 2 Ri-Accu + Ri-Charger 220 V.**  
**No. 05-172-01 - Oftalmoscopio con mango-AA.** **No. 05-172-04 - Otoscopio/Oftalmoscopio, 2 Ri-Accu + Ri-Charger 110 V.**  
**No. 05-172-02 - Otoscopio/Oftalmoscopio con mangos-AA.**

Combinazione per diagnostica con gli strumenti più moderni per uso otorinolaringoiatrico, con illuminazione alogena e a fibre ottiche 2,5 V. Teste dello strumento realizzate in materiale plastico robusto. **Otoscopio:** con attacco a vite. Lente d'ingrandimento mobile 2,5X. Connettore per test pneumatico. Dispositivo brevettato per l'espulsione degli specoli. **Oftalmoscopio:** con lenti correttive da -20 a +40 diottrie. Aperture: a cerchio grande, a semicerchio, a fessura, a stella, filtro verde. Manico di metallo per 2 batterie AA oppure 1 Ri-accu (batteria ricaricabile) per la ricarica nel ns. Ri-Charger. Tutte le combinazioni che comprendono l'otoscopio Ri-Star sono fornite con connettore di metallo per test pneumatico e con un tubo di plastica con 4 specoli auricolari riusabili 2, 3, 4 e 5 mm colore nero e 5 specoli monouso cad. da 2,5 e 4 mm colore grigio. Ogni combinazione è fornita in un astuccio moderno di plastica nera.

**No. 05-172-00 - Otoscopio con manico-AA.** **No. 05-172-03 - Otoscopio/Oftalmoscopio, 2 Ri-Accu + Ri-Charger 220 V.**  
**No. 05-172-01 - Oftalmoscopio con manico-AA.** **No. 05-172-04 - Otoscopio/Oftalmoscopio, 2 Ri-Accu + Ri-Charger 110 V.**  
**No. 05-172-02 - Otoscopio/Oftalmoscopio con manici-AA.**

Diagnostic Sets with Halogen Illumination  
Estuches de diagnóstico con iluminación halógena

**RI-SCOPE S OTOSCOPE/  
OPHTHALMOSCOPE**



State-of-the-art quality instrument with halogen illumination 2,5/3,5 V. Instrument head made of robust plastics. Bayonet fitting. **Otoscope.** Fiber optic, 2,5x removable lens. 4x swivel magnifying lens. Speculum ejector. **Ophthalmoscope:** Corrective lenses: -35 to +40 diopters. Apertures: large and small circle, semi-circle, fixation star, slit and grid. Filters: green, blue and polarizing filter. Each filter can be switched to each aperture. Focussing device. With plastic tube containing 4 reusable ear specula 2, 3, 4 and 5 mm black and 5 each disposable specula 2,5 and 4 mm gray as well as with metal connector for pneumatic otoscopy. All our instrument heads like bent arm illuminator etc. fit all our handles. They need to be ordered separately.

2,5 V / 220 V	2,5 V / 110 V	3,5 V / 220 V	3,5 V / 110 V
No. 05-174-00 - With C-handle.			
No. 05-174-01 - With S-handle.			
No. 05-174-02 - With recharg. S-handle plug-in style.	No. 05-174-12 - ditto	No. 05-174-22 - ditto	No. 05-174-32 - ditto
No. 05-174-03 - With C-handle, RI-Accu + RI-Charger.	No. 05-174-13 - ditto	No. 05-174-23 - ditto	No. 05-174-33 - ditto
No. 05-174-04 - With 2 C-handles, 2 RI-Accu + RI-Charger.	No. 05-174-14 - ditto	No. 05-174-24 - ditto	No. 05-174-34 - ditto
No. 05-174-05 - With S-handle, RI-Accu + RI-Charger.	No. 05-174-15 - ditto	No. 05-174-25 - ditto	No. 05-174-35 - ditto
No. 05-174-06 - With 2 S-handles, 2 RI-Accu + RI-Charger.	No. 05-174-16 - ditto	No. 05-174-26 - ditto	No. 05-174-36 - ditto

Instrumentos de alta calidad moderno con iluminación halógena 2,5/3,5 V. Cabezas de instrumentos de plástico resistente. Cierre de bayoneta. **Otoscopio:** Fibra óptica. Lente desmontable aumenta 2,5 veces más. Lente giratoria aumenta 4 veces más. Expulsor para espejuelos utilizados. **Oftalmoscopio:** Lentes de corrección: -35 hasta +40 dioptrías. Aperturas: círculo grande y pequeño, semicírculo, estrella fijadora, rendija y cuadrículado. Filtros: verde, azul, y polarizador. Se puede utilizar cada filtro con cada lente. Con enfoque. Con tubito de plástico con 4 espejuelos reutilizables 2, 3, 4 y 5 mm, negro y 5 espejuelos desechables de 2,5 y 4 mm, gris. Con conector metálico para test neumático. Todas nuestras cabezas de instrumentos como lámpara, espejuelo nasal, porta-abaja-lengua etc. se pueden fijar sobre nuestros mangos y se pueden pedir discrecional por añadidura.

2,5 V / 220 V	2,5 V / 110 V	3,5 V / 220 V	3,5 V / 110 V
No. 05-174-00 - Con mango C.			
No. 05-174-01 - Con mango S.			
No. 05-174-02 - Con mango S recargable a la red.	No. 05-174-12 - ídem	No. 05-174-22 - ídem	No. 05-174-32 - ídem
No. 05-174-03 - Con mango C, RI-Accu + RI-Charger.	No. 05-174-13 - ídem	No. 05-174-23 - ídem	No. 05-174-33 - ídem
No. 05-174-04 - Con 2 mangos C, 2 RI-Accu + RI-Charger.	No. 05-174-14 - ídem	No. 05-174-24 - ídem	No. 05-174-34 - ídem
No. 05-174-05 - Con mango S, RI-Accu + RI-Charger.	No. 05-174-15 - ídem	No. 05-174-25 - ídem	No. 05-174-35 - ídem
No. 05-174-06 - Con 2 mangos S, 2 RI-Accu + RI-Charger.	No. 05-174-16 - ídem	No. 05-174-26 - ídem	No. 05-174-36 - ídem

Gli strumenti più moderni, con illuminazione 2,5/3,5 V. Testa dello strumento realizzata in materiale plastico robusto. Attacco a baionetta. **Otoscopio:** a fibre ottiche. Lente estraibile 2,5x. Lente d'ingrandimento mobile 4x. Dispositivo di espulsione specolo. **Oftalmoscopio:** Lenti correttive da -35 a +40 diottrie. Aperture: a cerchio grande e piccolo, a semicerchio, a stella, a fessura, a reticolo. Filtri: verde, blu e filtro di polarizzazione. Dispositivo di messa a fuoco. Con tubo di plastica con 4 specoli auricolari riusabili 2, 3, 4 e 5 mm colore nero e 5 cad. specoli monouso 2,5 e 4 mm. Tutte le teste dello strumento come l'illuminatore a squadra, lo specolo nasale, il porta abbassalingua ecc. si adattano a tutti i ns. manici.

2,5 V / 220 V	2,5 V / 110 V	3,5 V / 220 V	3,5 V / 110 V
No. 05-174-00 - Con manico C.			
No. 05-174-01 - Con manico S.			
No. 05-174-02 - Con manico S ricaric. nella spina.	No. 05-174-12 - come s.	No. 05-174-22 - come s.	No. 05-174-32 - come s.
No. 05-174-03 - Con manico C, RI-Accu + RI-Charger.	No. 05-174-13 - come s.	No. 05-174-23 - come s.	No. 05-174-33 - come s.
No. 05-174-04 - Con 2 manici C, 2 RI-Accu + RI-Charger.	No. 05-174-14 - come s.	No. 05-174-24 - come s.	No. 05-174-34 - come s.
No. 05-174-05 - Con manico S, RI-Accu + RI-Charger.	No. 05-174-15 - come s.	No. 05-174-25 - come s.	No. 05-174-35 - come s.
No. 05-174-06 - Con 2 manici S, 2 RI-Accu + RI-Charger.	No. 05-174-16 - come s.	No. 05-174-26 - come s.	No. 05-174-36 - come s.



## Diagnostic Sets with Halogen Illumination Estuches de diagnóstico con iluminación halógena



Modern high precision quality instruments for ENT use. Instrument heads made of robust plastics with fiber optics and halogen illumination 2,5/3,5 V. Bayonet fitting. **Otoscope:** Removable 4x magnifying lens. Ejector for specula. **Ophthalmoscope:** corrective lenses: -35 to +40 diopters. Apertures: large + small circle, semi-circle, fixation star slit + grid. Filter: green, blue and polarizing filter. Each filter can be switched to each aperture. Unique focusing device. **Nasal speculum.** **Tongue blade holder.** **Throat mirrors:** No. 3 + 4. **Bent arm illuminator:** black chrome-plated. Plastic tube with 4 reusable ear specula 2, 3, 4 and 5 mm black + 5 each disposable ear specula 2,5 and 4 mm gray. Metal connector for pneumatic otoscopy. In plastic case.

<b>2,5 V / 220 V</b>	<b>2,5 V / 110 V</b>	<b>3,5 V / 220 V</b>	<b>3,5 V / 110 V</b>
No. 05-176-00 - With C-handle.			
No. 05-176-01 - With S-handle.			
No. 05-176-02 - With recharg. S-handle plug-in style.	No. 05-176-12 - ditto	No. 05-176-22 - ditto	No. 05-176-32 - ditto
No. 05-176-03 - With C-handle, Ri-Accu + Ri-Charger.	No. 05-176-13 - ditto	No. 05-176-23 - ditto	No. 05-176-33 - ditto
No. 05-176-05 - With S-handle, Ri-Accu + Ri-Charger.	No. 05-176-15 - ditto	No. 05-176-25 - ditto	No. 05-176-35 - ditto

Instrumentos de alta calidad para el campo de ORL. Cabezas de instrumentos de plástico resistente con fibra óptica e iluminación halógena 2,5/3,5 V. Cierre de bayoneta. **Otoscopio:** Lente desmontable aumenta 2,5 veces más. Lente giratoria aumenta 4 veces más. Expulsor para espéculos utilizados. **Oftalmoscopio:** Lentes de corrección: -35 hasta +40 D. Aperturas: círculo grande y pequeño, semicírculo, estrella fijadora, rendija y cuadrículado. Filtros: verde, azul y polarizador. Se puede utilizar cada filtro con cada apertura. Con enfoque. **Espéculo nasal.** **Porta-abaja-lengua.** **Especjos laríngeos:** no. 3 + 4. **Porta lámpara:** Cromado. Tubito de plástico con 4 espéc. reutiliz. 2, 3, 4 y 5 mm negro, 5 espéc. desechabl. 2,5 y 4 mm. En estuche plástico.

<b>2,5 V / 220 V</b>	<b>2,5 V / 110 V</b>	<b>3,5 V / 220 V</b>	<b>3,5 V / 110 V</b>
No. 05-176-00 - Con mango C.			
No. 05-176-01 - Con mango S.			
No. 05-176-02 - Con mango S recargable a la red.	No. 05-176-12 - ídem	No. 05-176-22 - ídem	No. 05-176-32 - ídem
No. 05-176-03 - Con mango C, Ri-Accu + Ri-Charger.	No. 05-176-13 - ídem	No. 05-176-23 - ídem	No. 05-176-33 - ídem
No. 05-176-05 - Con mango S, Ri-Accu + Ri-Charger.	No. 05-176-15 - ídem	No. 05-176-25 - ídem	No. 05-176-35 - ídem

Strumenti moderni di alta qualità per otorinolaringoiatria. Teste degli strumenti realizzati in plastica con illuminazione alogena e a fibre ottiche 2,5/3,5 V. Attacco a baionetta. **Otoscopio:** Lente d'ingrandimento estraibile 4x. Dispositivo per espulsione specoli auricolari. **Oftalmoscopio:** lenti correttive da -35 a +40 diottrie. Aperture: a cerchio grande e piccolo, semicerchio, a stella, a fessura, a reticolo. Filtri: verde, blu e filtro di polarizzazione. L'uso dei filtri con ciascuna apertura. Controllo della messa a fuoco. **Specolo nasale.** **Porta abbassalingua.** **Specchietti per laringe:** no. 3 e 4. **Portalampadina a squadra:** cromato. Tubo di plastica inclusi 4 specoli auric. riusab. 2, 3, 4 e 5 mm, 5 spec. auric. monouso cad. 2,5 e 4 mm. In astuccio di plastica nera.

<b>2,5 V / 220 V</b>	<b>2,5 V / 110 V</b>	<b>3,5 V / 220 V</b>	<b>3,5 V / 110 V</b>
No. 05-176-00 - Con manico C.			
No. 05-176-01 - Con manico S.			
No. 05-176-02 - Con manico S ricaric. nella spina.	No. 05-176-12 - come s.	No. 05-176-22 - come s.	No. 05-176-32 - come s.
No. 05-176-03 - Con manico C, Ri-Accu + Ri-Charger.	No. 05-176-13 - come s.	No. 05-176-23 - come s.	No. 05-176-33 - come s.
No. 05-176-05 - Con manico S, Ri-Accu + Ri-Charger.	No. 05-176-15 - come s.	No. 05-176-25 - come s.	No. 05-176-35 - come s.



## Head Mirror Lámparas frontales



05-180-94



05-180-93



ZIEGLER  
05-180-90  
Complete



05-180-92

05-180-90  
Ziegler Head Mirror,  
With Black Head Band and  
Ball Socket  
90 mm ø

05-180-90  
Ziegler espejo frontal, com-  
pleto con cinta negra,  
con articulación,  
90 mm ø

05-180-90  
Specchio frontale, Ziegler,  
completo con fascia nera,  
con snodo sferico,  
90 mm di ø

05-180-92  
Head Band Only

05-180-92  
cinta, suelta

05-180-92  
fascia, sola

05-180-93  
Mirror Only  
90 mm ø

05-180-93  
Espejo, suelta  
90 mm ø

05-180-93  
Specchio,  
solo 90 mm ø

05-180-94  
Socket Joint for Head Band  
only

05-180-94  
Articulación para cintas fron-  
tales suelta

05-180-94  
Snodo sferico per fascie  
frontali



## Head Light Lámparas frontales

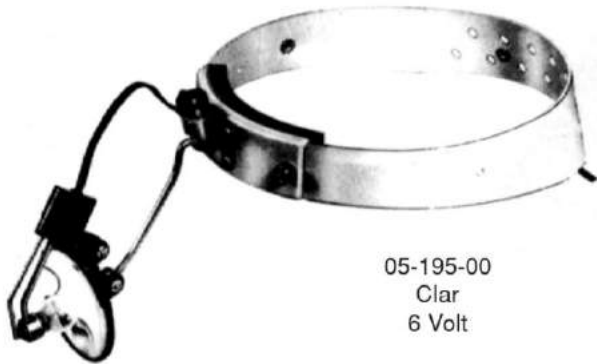

05-195-00  
Clar  
6 Volt

Complete with Head Band and Cable  
completa con cinta frontal y cable  
completa con fascia frontale e cordone



05-195-01

Glass Mirror without Frame  
Reflector de cristal, sin montura  
Riflettore di cristallo, senza montatura



05-195-06  
6 Volt

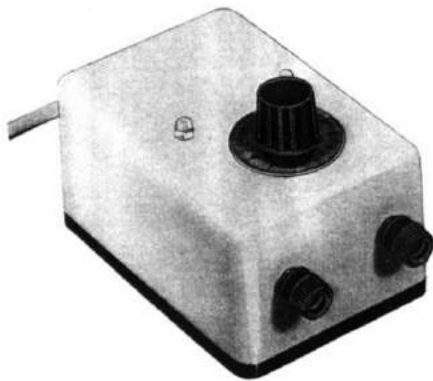

05-195-07 Mini Transformer Unit  
220 Volt 0 - 10 Volt / 3 Watt  
Transformador eléctrico pequeño  
Mini-trasformatore elettrico

05-195-08  
110 Volt 0 - 10 Volt / 3 Watt  
Mini-Transformer Unit  
Transformador eléctrico pequeño  
Mini-trasformatore elettrico

05-195-09 Clar Special Socket Joint  
Articulación especial de Clar  
Snodo speciale di Clar

05-195-04 Head Band Only  
cinta frontal, suerta  
fascia frontale, sola

05-195-10 Clar Spring Metal Head Band Only,  
With Cable Clips, Fixing Screw and  
Socket Joint  
Casco frontal de resorte metálico  
suelto de Clar, con bridas de  
cable, y tornillo de sujeción con  
articulación  
Fascia metallica a casco di Clar,  
solo, con portacordoni e vite di  
fissaggio a snodo

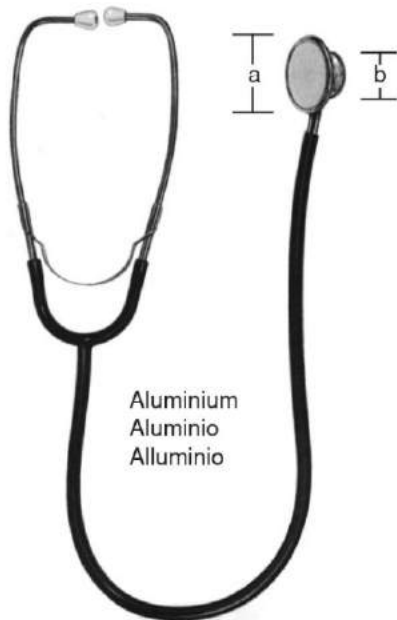

Aluminium  
Aluminio  
Alluminio

DUPLEX

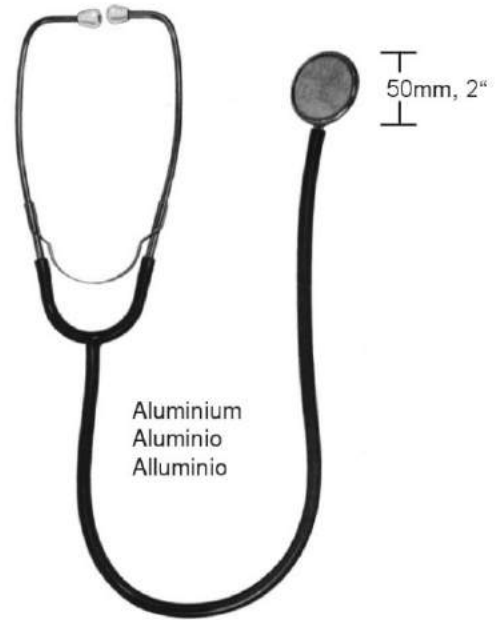

Aluminium  
Aluminio  
Alluminio

NURSES  
05-248-00

	a	b	
05-246-00	48 mm, 1.9"	30 mm, 1.2"	Adult
05-246-01	39 mm, 1.5"	25 mm, 1.0"	Child
05-246-02	21 mm, 0.8"	21 mm, 0.8"	Neonatal



PINARD  
05-260-15 15 cm, 6"  
Aluminum



PINARD  
05-262-18 18 cm, 7"  
Wood  
madera, legno



Percussion Hammers  
Martillos de percusión



TAYLOR - USA  
05-288-17 17 cm, 6 3/4"  
05-288-20 20 cm, 8"



BABINSKY  
05-292-22 22 cm, 8 3/4"



TROEMNER  
05-294-24 24 cm, 9 1/2"



DEJERINE  
05-304-20 20 cm, 8"



BERLINER  
05-306-17 17 cm, 6 3/4"

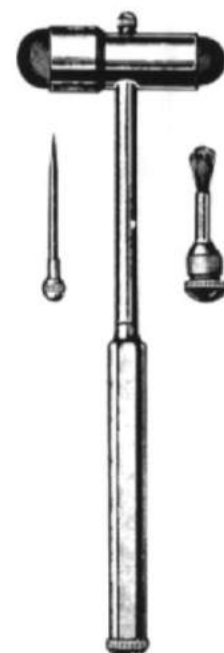

BUCK  
05-308-18 18 cm, 7"





## Examination and Measuring Instruments Instrumentos para exámenes y medidas

Dynamometer  
Dinamómetro  
Dinamometro



COLLIN  
05-310-01 Adult  
adultos, adulti  
05-310-02 Child, niños, bambini

Goniometer  
Goniómetro  
Goniometro



MOELTGEN  
05-312-01

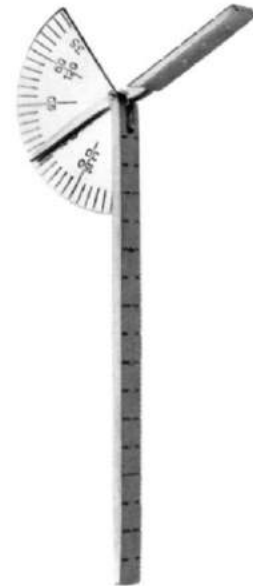

Finger Goniometer  
Goniómetro para dedos  
Goniometro per le dita  
05-314-01



WARTENBERG  
05-320-19 19 cm, 7 1/2"



Steel Tape Measure  
de acero  
di acciaio  
05-350-15 5 Feet



Metal Ruler		
05-340-10	10 cm	4"
05-340-15	15 cm	6"
05-340-20	20 cm	8"
05-340-30	30 cm	12"
05-340-50	50 cm	20"

Caliper  
Calibre

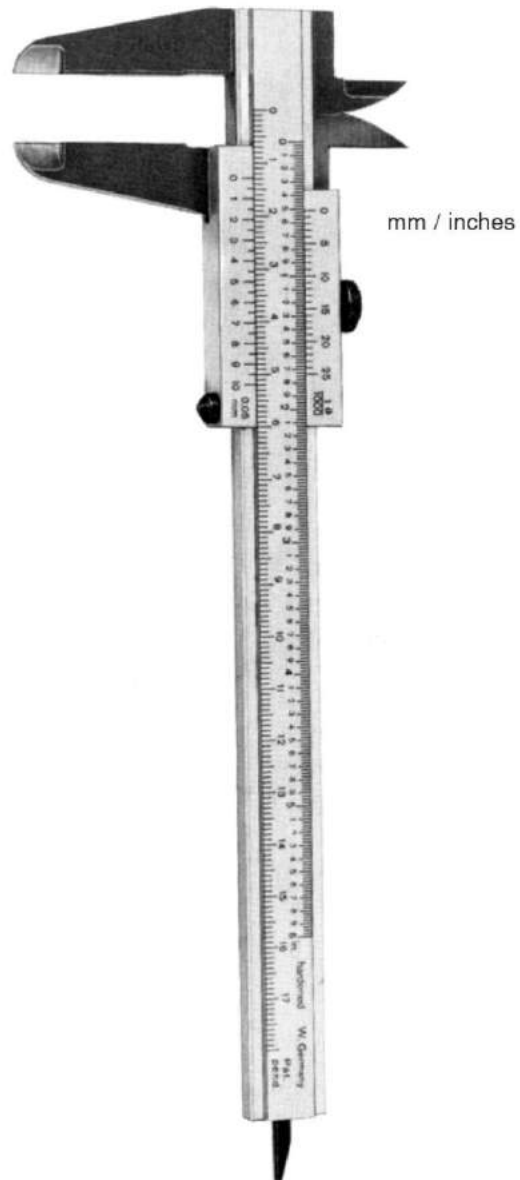

05-360-21  
21 cm, 8 1/4"



POOLE  
07-130-10 10 mm  $\varnothing$ , 0.4"  
30 Fr



POOLE  
07-140-08 8 mm  $\varnothing$ , 0.3"  
23 Fr



BABY-YANKAUER  
07-150-21 21 cm, 8 1/4"  
YANKAUER  
07-150-27 27 cm, 10 1/2"



## Suction Tubes, Forceps Tubos de aspiración

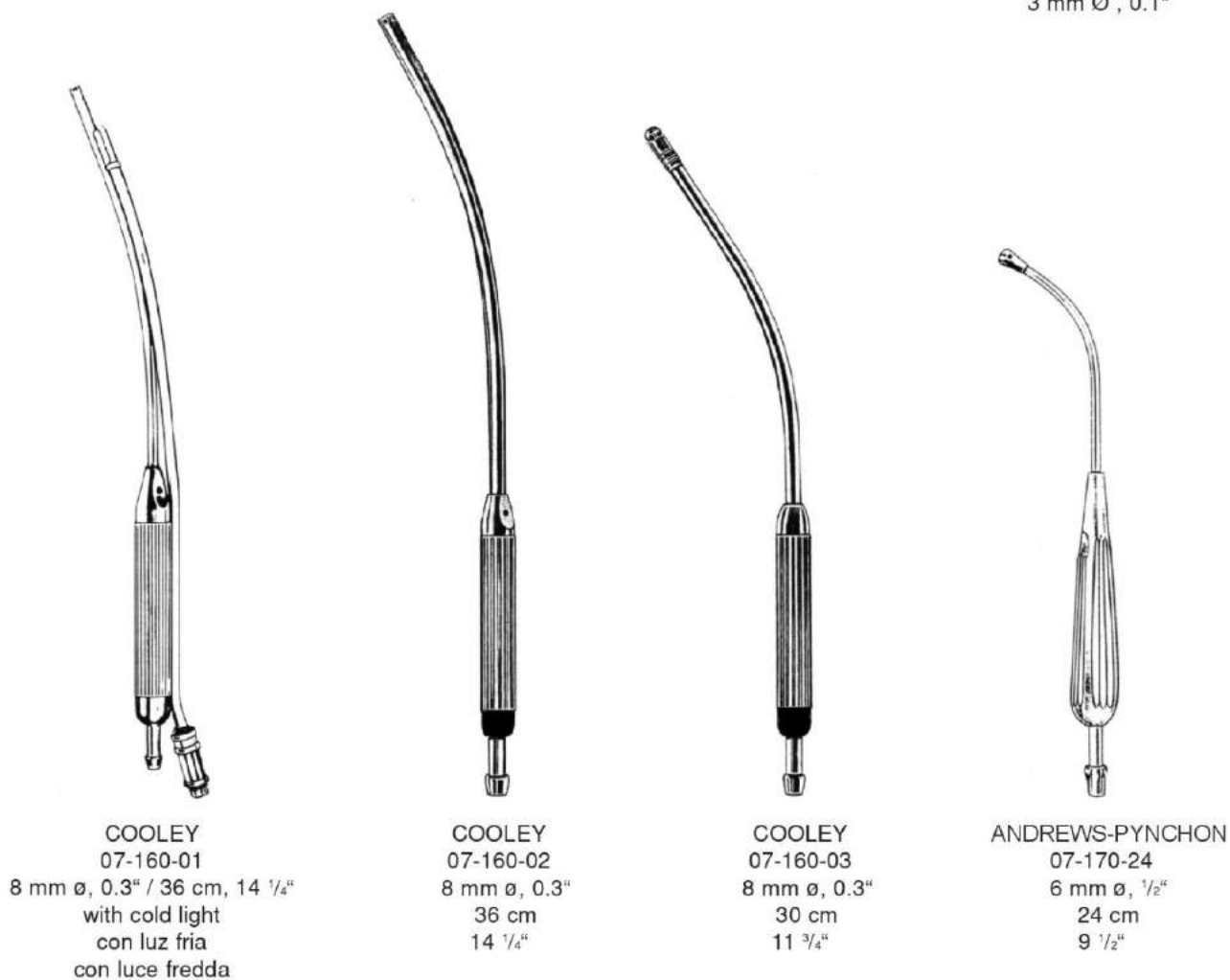
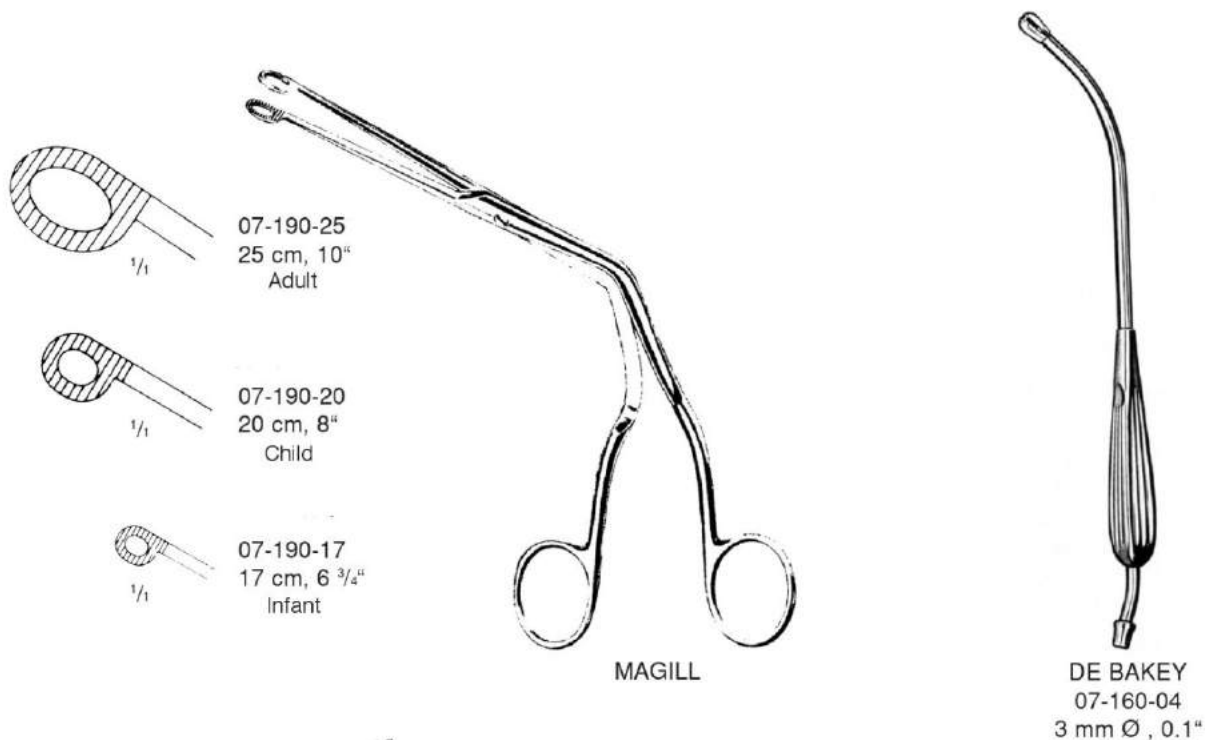



### McINTOSH

				Cold Light
Fig. 0	5.5 cm	2 1/4"	07-210-00	07-211-00
Fig. 1	7.5 cm	3"	07-210-01	07-211-01
Fig. 2	9.0 cm	3 1/2"	07-210-02	07-211-02
Fig. 3	11.0 cm	4 3/8"	07-210-03	07-211-03
Fig. 4	13.5 cm	5 1/4"	07-210-04	07-211-04

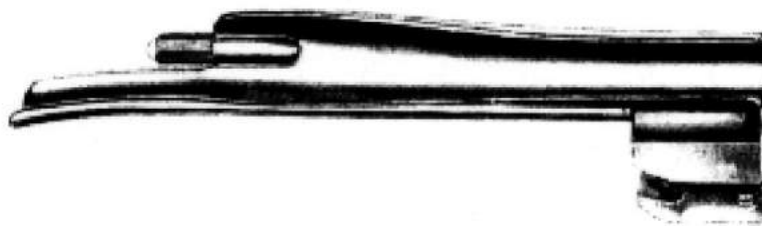

### FOREGGER

				Cold Light
Fig. 0	5.5 cm	2 1/4"	07-220-00	07-221-00
Fig. 1	7.0 cm	2 3/4"	07-220-01	07-221-01
Fig. 2	9.0 cm	3 1/2"	07-220-02	07-221-02
Fig. 3	11.0 cm	4 3/8"	07-220-03	07-221-03
Fig. 4	13.5 cm	5 1/4"	07-220-04	07-221-04



Laryngoscopes  
Laringoscopios



07-230-00  
55 mm, 2 1/2"  
Working Length  
largo útil  
lunghezza utile

For Infants  
para neonatales  
per neonati



07-230-01  
80 mm, 3 1/8"  
Working Length  
largo útil  
lunghezza utile

For Children  
para niños  
per bambini



07-230-02  
130 mm, 5"  
Working Length  
largo útil  
lunghezza utile

For Adolescents  
para adolescentes  
per adolescenti



07-230-03  
170 mm, 6 3/4"  
Working Length  
largo útil  
lunghezza utile

For Women  
para mujeres  
per donne



07-230-04  
180 mm, 7"  
Working Length  
largo útil  
lunghezza utile

For Men  
para hombres  
per uomini

MILLER



McINTOSH



FOREGGER

07-203-00

Set consisting of:  
1 Case  
1 Handle  
3 Blades (Fg. 2-4)

Juego compuesto de:  
1 Estuche  
1 Mango  
3 Hoja (Fg. 2-4)

Set composto da:  
1 Astuccio  
1 Manico  
3 Spatole (Fg. 2-4)

07-204-00

Set consisting of:  
1 Case  
1 Handle  
4 Blades (Fg. 1-4)

Juego compuesto de:  
1 Estuche  
1 Mango  
4 Hoja (Fg. 1-4)

Set composto da:  
1 Astuccio  
1 Manico  
4 Spatole (Fg. 1-4)

07-223-00

Set consisting of:  
1 Case  
1 Handle  
3 Blades (Fg. 2-4)

Juego compuesto de:  
1 Estuche  
1 Mango  
3 Hoja (Fg. 2-4)

Set composto da:  
1 Astuccio  
1 Manico  
3 Spatole (Fg. 2-4)

07-224-00

Set consisting of:  
1 Case  
1 Handle  
4 Blades (Fg. 1-4)

Juego compuesto de:  
1 Estuche  
1 Mango  
4 Hoja (Fg. 1-4)

Set composto da:  
1 Astuccio  
1 Manico  
4 Spatole (Fg. 1-4)

Battery Handles  
Mango de pila



07-233-18 18 mm  $\varnothing$ ,  $\frac{3}{4}$ "

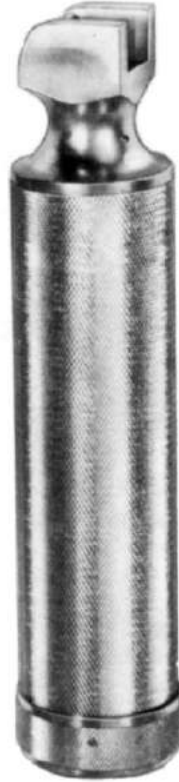

07-234-28 28 mm  $\varnothing$ , 1"  
07-234-37 37 mm  $\varnothing$ , 1  $\frac{1}{2}$ "



07-238-01 30 mm  $\varnothing$ , 1  $\frac{1}{4}$ "



07-239-01  
Fig. 0-1



07-239-02  
Fig. 2-4





Fiberoptic Handles  
Mango de pila luz fria



Halogen Lamp  
Lámpara Halógena  
Lampada Alogena  
07-239-03



07-238-02  
18 mm  $\varnothing$   
 $\frac{3}{4}$ "



07-238-03  
30 mm  $\varnothing$   
1  $\frac{1}{4}$ "



## Battery Handle Mangos para pilas



07-240-30 30 mm  $\varnothing$ , 1 1/4"  
Handle with Transformer Connection  
Mango con conexión a transformadores  
Manico con connessione al trasformatore



07-241-11 110 V  
07-241-22 220 V

Transformer 110 Volt for American Connection  
Transformador 110 V con conexión americana  
Trasformatore 110 V ricarica batteria

Transformer 220 Volt with Cable 1.40 m (55")  
Transformador, 220 V con cable de 1.40 m (55")  
Trasformatore 220 V ricarica batteria



**KLEINSASSER**

Operating Laryngoscope  
Stainless Steel  
Tube - Inner Surface Matte  
Outer Surface Polished  
Handle - Matte Finished

Laringoscopio para operaciones:  
Acero inoxidable  
Pala: Superficie interior: Mate  
Superficie exterior: Brillante  
Mango entero: Mate

Laringoscopio a luce  
fredda per microchirurgia  
endolaringeo  
tubo: interiore opaco – esterno lucido  
manico: opaco

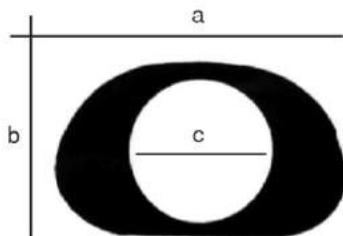

Nr.	L (mm)	a (mm)	b (mm)	c (mm)
07-301-01	135	21.8	14.0	13.0
07-301-02	152	22.5	14.8	13.0
07-301-03	182	23.0	15.0	14.0
07-301-04	172	29.5	18.0	17.0
07-301-05	172	31.5	21.5	19.0

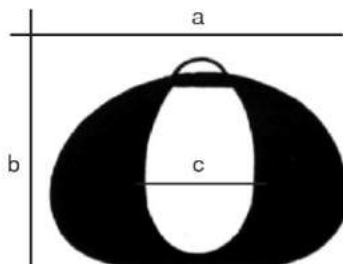

Nr.	L (mm)	a (mm)	b (mm)	c (mm)
07-301-06	182	29.0	20.0	16.0 x 26.0
07-301-07	222	29.0	20.0	16.0 x 26.0



## Laryngoscopes Laringoscopios

07-300-01/02 Chest Support for adults/children complete consisting of:  
 07-300-03 Support rod for adults 34 cm / 07-300-06 Ring / 07-300-05 Joint  
 07-300-04 Support rod for children 24 cm / 07-300-06 Ring / 07-300-05 Joint  
 07-300-01/02 Soporte pectoral para adultos/ninos compuesto de:  
 07-300-03 para adultos 34 cm / 07-300-06 / 07-300-05  
 07-300-04 para ninos 24 cm / 07-300-06 / 07-300-05  
 07-300-01/02 Braccio portalarinoscopio sternale per adulti/bambini composto da:  
 07-300-03 per adulti 34 cm / 07-300-06 anello / 07-300-05 giunto  
 07-300-04 per bambini 24 cm / 07-300-06 anello / 07-300-05 giunto

Operating Laryngoscope, KLEINSASSER  
 Laringoscopio operativo, Kleinsasser  
 Laringoscopio operativo, Kleinsasser



07-300-03 34 cm, 13.4"  
 (Adults/adultos/adulti)

07-300-04 24 cm, 9 1/2"  
 (Children/Niños/Bambini)

07-300-06 Ring  
 anillo  
 anello

07-300-05  
 Joint  
 giunto

Fiberglass Light Guide  
 Portadores de luz fria – portatore di luce fredda  
 a fibre di vetro



07-302-01 for Laryngoscope  
 07-301-01, 07-301-02

07-303-01  
 Injection Drain Tube for Laryngoscopes: 07-301-01 to 07-301-07  
 Canúla de inyeccion para laringoscopios: 07-301-01 to 07-301-07  
 Cannula ad iniezione per laringoscopi: 07-301-01 to 07-301-07

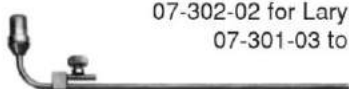

07-302-02 for Laryngoscope  
 07-301-03 to 07-301-06

07-304-01  
 Suction Tube for Laryngoscopes: 07-301-03 to 07-301-07  
 Canúla de succion para laringoscopios: 07-301-03 to 07-301-07  
 Tubo di aspirazione per laringoscopi: 07-301-03 to 07-301-07



07-302-03 for Laryngoscope  
 07-301-07





Laryngoscopes  
Laringoscopios

HOLINGER Laryngoscope  
HOLINGER Laringoscopio  
HOLINGER Laringoscopi

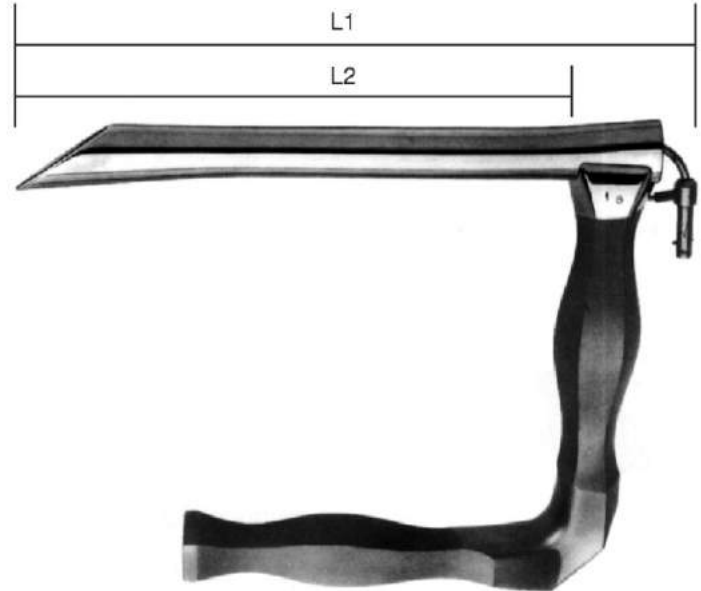

	L1	L2	Light Guide Portador de luz portatore di luce
07-310-01	180 mm	157 mm	07-311-01
07-310-02	170 mm	146 mm	07-311-02
07-310-03	120 mm	98 mm	07-311-03
07-310-04	90 mm	77 mm	07-311-04

JACKSON Laryngoscope  
JACKSON Laringoscopio  
JACKSON Laringoscopi

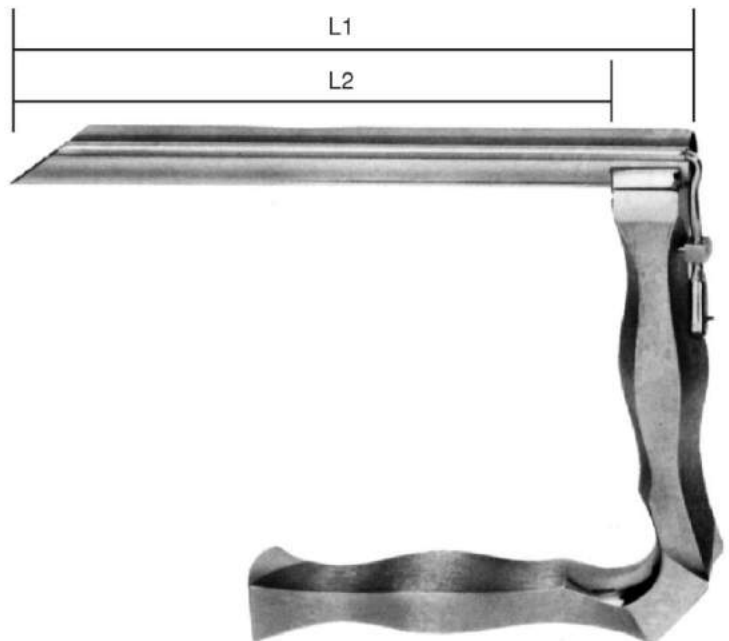

	L1	L2	O/D dm-exterior dm-esterno	I/D dm-interior dm-interno	Light Guide Portador de luz portatore di luce
07-320-01	160 mm	135 mm	17.5 mm	14.5 mm	07-321-01
07-320-02	160 mm	135 mm	14.5 mm	12.0 mm	07-321-02
07-320-03	120 mm	105 mm	14.0 mm	11.5 mm	07-321-03
07-320-04	90 mm	75 mm	13.0 mm	10.0 mm	07-321-04

Scalpel Handles  
Mangos de bisturíes

For Blade Sizes:  
para las hojas  
per lama bisturi

- (A) 10, 11, 12, 13, 15, 16
- (B) 18, 19, 20, 21, 22, 23, 24, 25



09-103-00  
#3

(A)



09-103-01  
#3 With Scale

(A)



09-103-02  
#3L

(A)

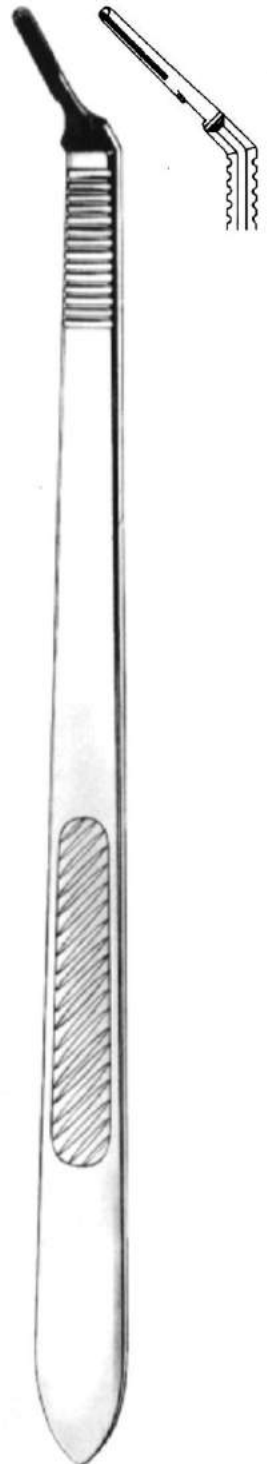

09-109-03  
#3L Angled

(A)



Scalpel Handles  
Mangos de bisturíes

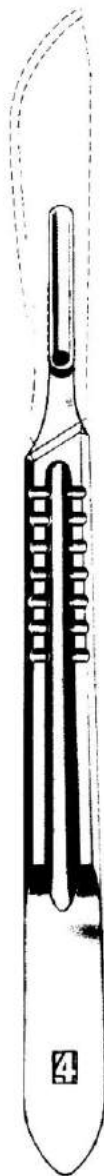

09-104-00  
#4  
(B)



09-104-02  
#4L  
(B)

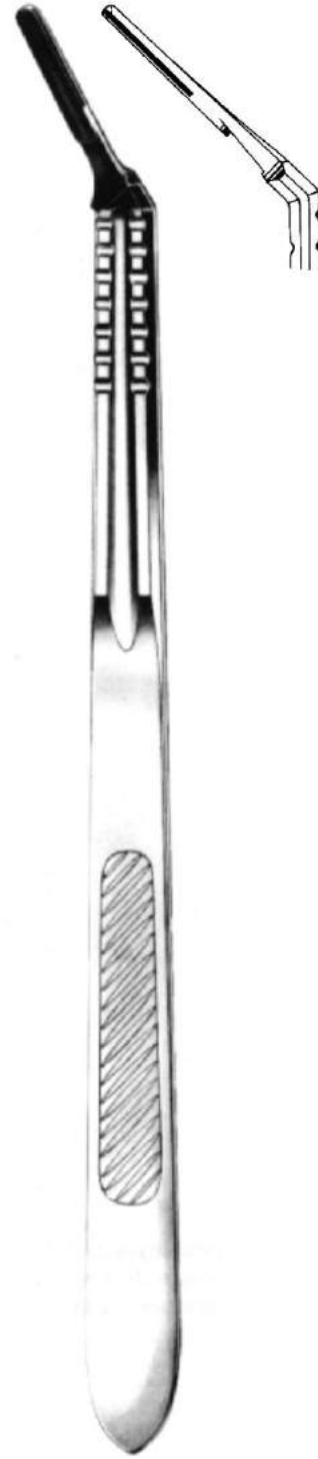

09-105-02  
#4L  
(B)



Scalpel Handles  
Mangos de bisturíes



09-107-00  
#7  
(A)



09-107-01  
#7K  
(A)



09-108-00  
#8  
(B)





09-161-00 09-162-00 09-165-00 09-167-00

Box of 10  
en cajas de 10  
confezione di 10

09-109-10 10.0 cm, 4"  
09-109-13 13.0 cm, 5"  
09-109-15 15.5 cm, 6"



## Scalpel Blades, Sterile Hojas de bisturí, estéril



09-110-00



09-111-00



09-112-00



09-113-00



09-115-00



09-116-00



09-118-00



09-119-00



09-120-00



09-121-00



09-122-00



09-123-00



09-124-00



09-125-00



Product Number  
Numero

Expiration Date  
Data di scadenza

Sterile Indicator  
Indicatore

Packages of 100 each  
en cajas de 100 c/u  
confezione di 100 pezzi

BOOTNAS Scalpel Blade Remover  
Quita hojas  
Distributore lame



09-130-00



Disposable Scalpels, Sterile  
Bisturíes uso único, estériles



09-210-00



09-211-00



09-212-02



09-213-00



09-215-00



09-215-01



09-218-00



09-219-00



09-220-00



09-221-00



09-222-00



09-223-00



09-224-00



09-225-00

Packages of 10 each  
en cajas de 10 c/u  
confezione di 10 pezzi



## Amputation Knives Cuchillos para amputación

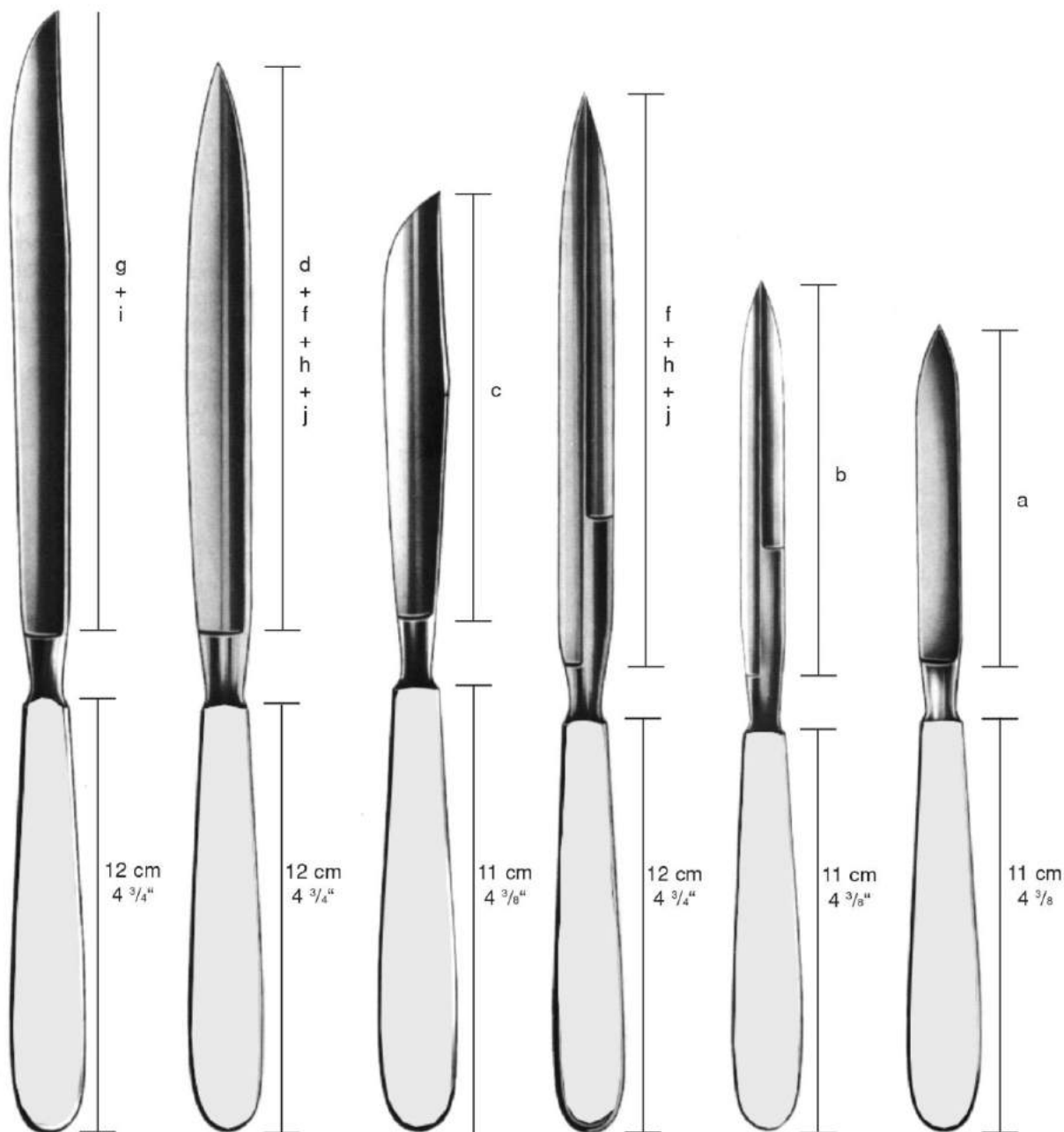

LISTON  
09-200-17  
09-200-20

BOOTNAS  
09-201-13  
09-201-16  
09-201-19  
09-201-22

LANGENBECK  
09-202-12

CATLIN  
Double  
Edge  
filo doble  
doppio taglio  
09-203-16  
09-203-19  
09-203-22

09-204-11  
Interosseous Knife  
Double Edge  
Cuchillo interóseo  
filo doble  
Coltello interosseo  
doppio taglio

09-205-09  
Phalangeal Knife  
Cuchillos para  
falanges  
Coltello per falangi

Length of Blades  
Largo de hojas  
Lunhezze delle lame

a - 9.5 cm	c - 12.0 cm	e - 15.0 cm	g - 17.0 cm	i - 20.0 cm
b - 11.0 cm	d - 13.0 cm	f - 16.0 cm	h - 19.0 cm	j - 22.0 cm
a - 3 3/4"	c - 4 3/4"	e - 6"	g - 6 3/4"	i - 8"
b - 4 3/8"	d - 5"	f - 6 1/4"	h - 7 1/2"	j - 8 3/4"



Blade Breakers, Razor Blades  
Rompe-hojas, hojas de afeitar



TROUTMAN-CHRIS  
09-290-09 9 cm, 3 1/2"



BOOTNAS  
09-291-11 11 cm, 4 3/8"



CASTROVIEJO  
09-294-13 13 cm, 5 1/8"

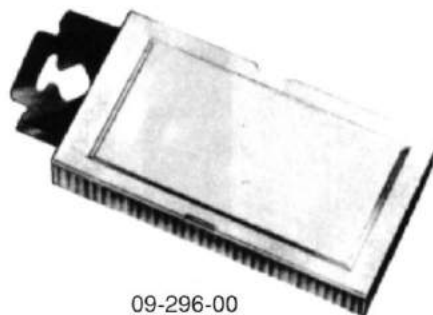

09-296-00

Package of 10 each  
Cajita 10 c/u  
Confezione 10 pezzi



Scalpels, Stainless Steel  
Bisturíes, mango metálico



Fig. 1  
09-402-01  
15 cm, 6"  
30 mm, 1.2"



Fig. 2  
09-402-02  
15 cm, 6"  
36 mm, 1.4"



Fig. 3  
09-402-03  
15.5 cm, 6"  
40 mm, 1 1/2"



Fig. 4  
09-402-04  
16 cm, 6 1/4"  
45 mm, 1 3/4"



Fig. 5  
09-402-05  
16 cm, 6 1/4"  
50 mm, 2"



Fig. 6  
09-402-06  
15 cm, 6"  
27 mm, 1"



Fig. 7  
09-402-07  
15 cm, 6"  
35 mm, 1.4"



Fig. 8  
09-402-08  
16 cm, 6 1/4"  
40 mm, 1 1/2"



Fig. 9  
09-402-09  
16 cm, 6 1/4"  
47 mm, 1.9"



Fig. 10  
09-402-10  
17 cm, 6 3/4"  
50 mm, 2"





## Resection and Cartilage Knives Cuchillos para resección/cartilagos



6.5 cm  
2.6"

Periosteum Knife  
with Raspatory  
Cuchillo para  
periostio, con  
periostótamo  
Coltello per  
periostio con  
raschino

19 cm, 7 1/2"

09-403-01

Stainless Steel  
mango metálico  
manico di metallo



6.5 cm  
2.6"

19 cm, 7 1/2"

09-403-02

Wooden Handle  
mango de madera  
manico in legno



5.5 cm  
2.2"

09-412-05



5.5 cm  
2.2"

18 cm, 7"

09-410-05  
LANGENBECK



## Autopsy, Brain and Post Mortem Knives Cuchillos para autopsia- cerebro- órganos

Length of Blades  
Largo de hojas  
Lunghezze delle lame

- a - 8.5 cm, 3.4"
- b - 9.5 cm, 3 3/4"
- c - 11.0 cm, 4 3/8"
- d - 14.0 cm, 5 1/2"
- e - 16.0 cm, 6 1/4"
- f - 17.0 cm, 6 3/4"
- g - 19.5 cm, 7 3/4"
- h - 20.0 cm, 8"
- i - 24.0 cm, 9 1/2"

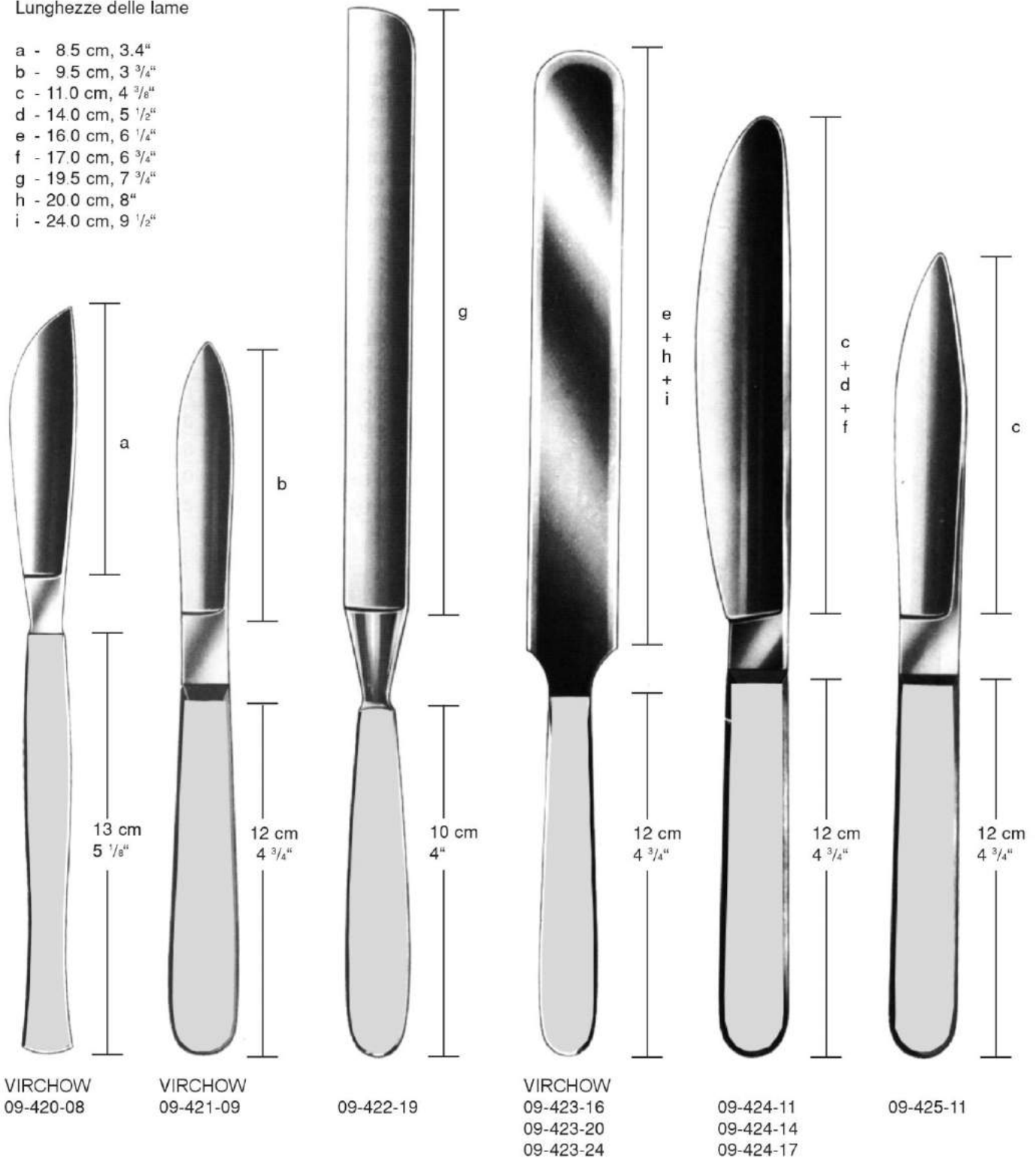





SCHINK  
09-490-00  
30 cm, 11 3/4"  
0.1 - 2 mm  
Complete  
with  
09-490-01  
09-490-02



09-490-01  
Spare Blade  
Hoja de repuesto  
Lama di ricambio per dermatomo

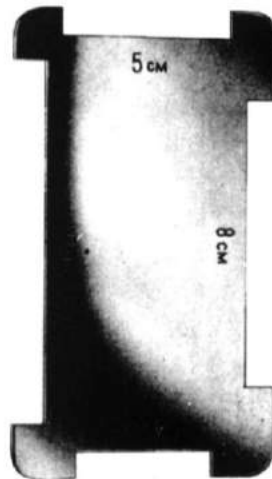

09-490-02  
Skin Straightening Plate  
Placa para extender la piel  
Placca per stendipelle



09-496-00  
Razor 8 cm, 3 1/8"  
Navaja  
Rasoio



Dermatome, Razor  
Dermátomo, Navajas

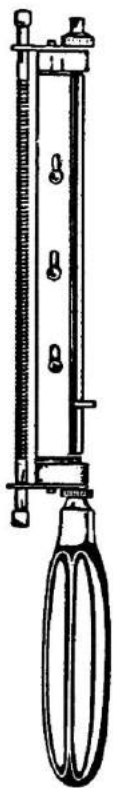

HUMBY  
09-495-31 31 cm, 12 1/4"  
0.1 - 1.2 mm  
Complete



09-496-31  
Blade Only  
Hoja de repuesto  
Lame di ricambio



SILVER  
09-498-00  
190 mm, 7 1/2"  
Skin Graft Knife, With Blade  
Senza lama utilizzo con lamette  
da barba normale

09-296-00  
Spare Blades  
Package of 10



WATSON  
09-499-00  
300 mm, 11 3/4"  
Skin Graft Knife, With Blade  
Senza lama utilizzo con lamette  
da barba normale

09-499-01  
Blade Only  
bisturi



## Operating Scissors Tijeras para cirugía



STANDARD-Straight BL/BL

- 11-102-11 11.5 cm, 4 1/2"
- 11-102-13 13.0 cm, 5"
- 11-102-14 14.5 cm, 5 1/2"
- 11-102-14 TC**
- 11-102-15 15.5 cm, 6"
- 11-102-16 16.5 cm, 6 1/2"
- 11-102-18 18.5 cm, 7 1/4"
- 11-102-20 20.0 cm, 8"



STANDARD-Straight SH/BL

- 11-110-11 11.5 cm, 4 1/2"
- 11-110-13 13.0 cm, 5"
- 11-110-14 14.5 cm, 5 1/2"
- 11-110-14 TC**
- 11-110-15 15.5 cm, 6"
- 11-110-16 16.5 cm, 6 1/2"
- 11-110-18 18.5 cm, 7 1/4"
- 11-110-20 20.0 cm, 8"



STANDARD-Straight SH/SH

- 11-120-11 11.5 cm, 4 1/2"
- 11-120-13 13.0 cm, 5"
- 11-120-14 14.5 cm, 5 1/2"
- 11-120-14 TC**
- 11-120-15 15.5 cm, 6"
- 11-120-16 16.5 cm, 6 1/2"
- 11-120-18 18.5 cm, 7 1/4"
- 11-120-20 20.0 cm, 8"



STANDARD-Curved BL/BL

- 11-103-11 11.5 cm, 4 1/2"
- 11-103-13 13.0 cm, 5"
- 11-103-14 14.5 cm, 5 1/2"
- 11-103-14 TC**
- 11-103-15 15.5 cm, 6"
- 11-103-16 16.5 cm, 6 1/2"
- 11-103-18 18.5 cm, 7 1/4"
- 11-103-20 20.0 cm, 8"



STANDARD-Curved SH/BL

- 11-111-11 11.5 cm, 4 1/2"
- 11-111-13 13.0 cm, 5"
- 11-111-14 14.5 cm, 5 1/2"
- 11-111-14 TC**
- 11-111-15 15.5 cm, 6"
- 11-111-16 16.5 cm, 6 1/2"
- 11-111-18 18.5 cm, 7 1/4"
- 11-111-20 20.0 cm, 8"



STANDARD-Curved SH/SH

- 11-121-11 11.5 cm, 4 1/2"
- 11-121-13 13.0 cm, 5"
- 11-121-14 14.5 cm, 5 1/2"
- 11-121-14 TC**
- 11-121-15 15.5 cm, 6"
- 11-121-16 16.5 cm, 6 1/2"
- 11-121-18 18.5 cm, 7 1/4"
- 11-121-20 20.0 cm, 8"

## Dissecting Scissors Tijeras de disección



11-128-14  
14 cm  
5 1/2"

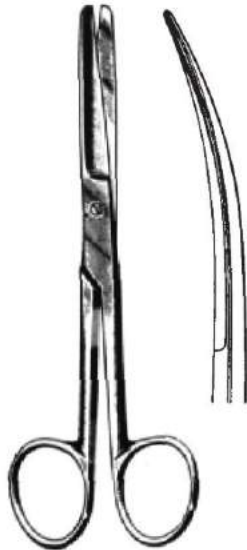

— DEAVER —  
11-130-14 14 cm 11-131-14  
5 1/2"

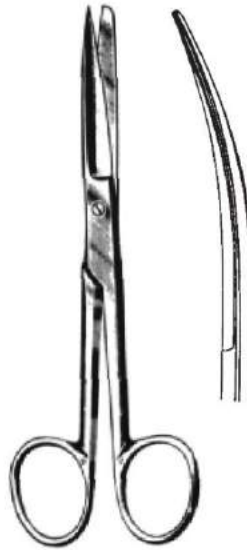

— DEAVER —  
11-140-14 14 cm 11-141-14  
5 1/2"

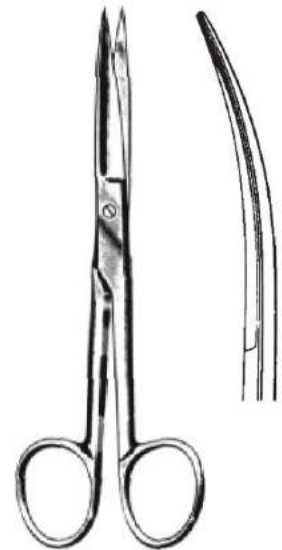

— DEAVER —  
11-150-14 14 cm 11-151-14  
5 1/2"

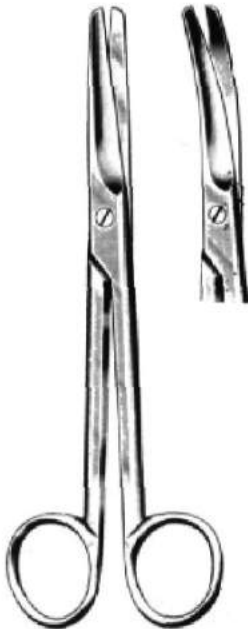

— MAYO —

11-160-14	14.5 cm	11-161-14
11-160-14 TC	14.5 cm	11-161-14 TC
11-160-17	17.0 cm	11-161-17
11-160-17 TC	17.0 cm	11-161-17 TC
11-160-23	23.0 cm	11-161-23
11-160-23 TC	23.0 cm	11-161-23 TC

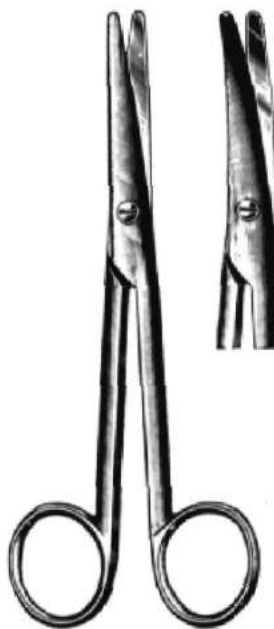

— MAYO-STILLE —

11-170-15	15.0 cm	11-171-15
11-170-15 TC	15.0 cm	11-171-15 TC
11-170-17	17.0 cm	11-171-17
11-170-17 TC	17.0 cm	11-171-17 TC
11-170-21	21.0 cm	11-171-21
11-170-21 TC	21.0 cm	11-171-21 TC

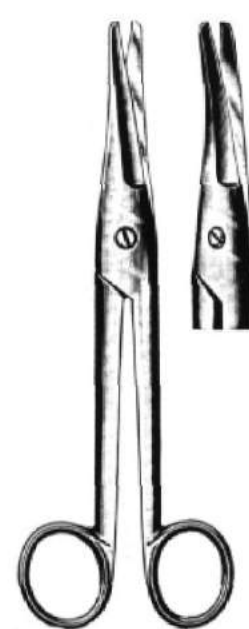

— MAYO-NOBLE —

11-180-17	17 cm	11-181-17
	6 3/4"	



Dissecting Scissors  
Tijeras de disección



LEXER  
11-190-16  
**11-190-16 TC**  
16 cm, 6 1/4"

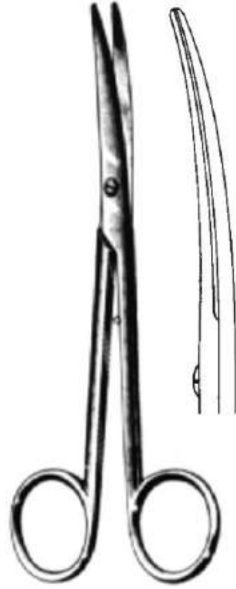

LEXER  
11-191-16  
**11-191-16 TC**  
16 cm, 6 1/4"



BABY-LEXER  
11-202-10 11-203-10  
**11-202-10 TC 11-203-10TC**  
10 cm, 4"

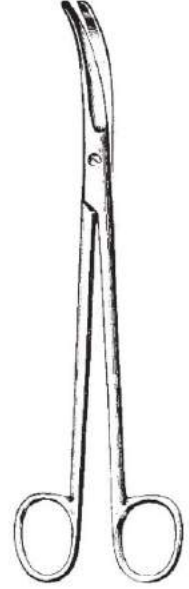

JORGENSEN  
11-204-22  
22 cm, 8 3/4"



METZENBAUM  
11-280-12 12 cm **11-280-12 TC**  
11-280-14 14 cm **11-280-14 TC**  
11-280-18 18 cm **11-280-18 TC**  
11-280-20 20 cm **11-280-20 TC**  
11-280-23 23 cm **11-280-23 TC**  
11-280-25 25 cm **11-280-25 TC**  
11-280-28 28 cm **11-280-28 TC**  
11-280-30 30 cm **11-280-30 TC**

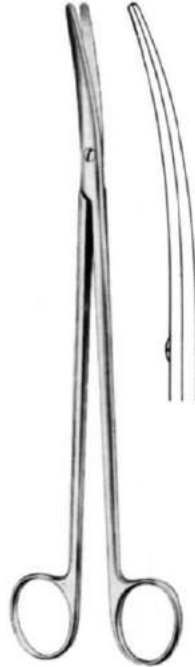

METZENBAUM  
11-281-12 12 cm **11-281-12 TC**  
11-281-14 14 cm **11-281-14 TC**  
11-281-18 18 cm **11-281-18 TC**  
11-281-20 20 cm **11-281-20 TC**  
11-281-23 23 cm **11-281-23 TC**  
11-281-25 25 cm **11-281-25 TC**  
11-281-28 28 cm **11-281-28 TC**  
11-281-30 30 cm **11-281-30 TC**



METZENBAUM FINO  
11-282-14 14 cm **11-282-14 TC**  
11-282-18 18 cm **11-282-18 TC**  
11-282-20 20 cm **11-282-20 TC**  
11-282-23 23 cm **11-282-23 TC**  
11-282-25 25 cm **11-282-25 TC**  
11-282-28 28 cm **11-282-28 TC**

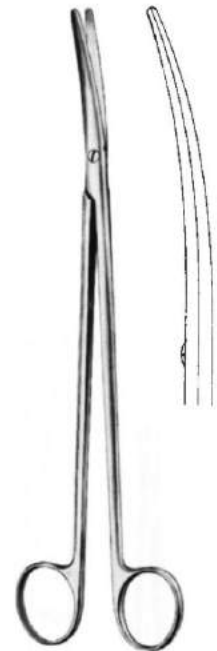

METZENBAUM FINO  
11-283-14 14 cm **11-283-14 TC**  
11-283-18 18 cm **11-283-18 TC**  
11-283-20 20 cm **11-283-20 TC**  
11-283-23 23 cm **11-283-23 TC**  
11-283-25 25 cm **11-283-25 TC**  
11-283-28 28 cm **11-283-28 TC**



## Operating Scissors Tijeras para cirugía

LINCOLN Scissors 11-292-18  
 DEMARTEL Scissors 11-294-18  
 LILLIE Scissors 11-296-20



**METZENBAUM "S"**

11-291-18 11-291-18 TC  
 11-291-20 11-291-20 TC  
 11-291-23 11-291-23 TC

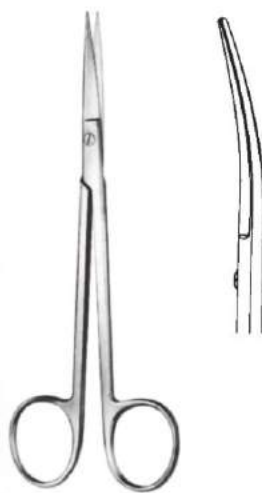

**SANVENERO**

11-302-14 14 cm 11-303-14  
 5 1/2"



**JOSEPH**

11-304-14 14 cm 11-305-14  
 5 1/2"

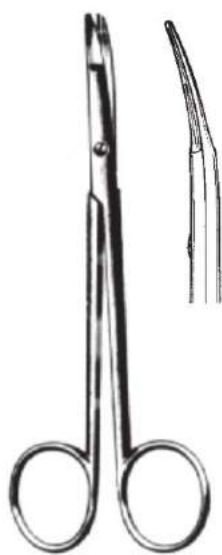

**KILNER**

11-310-12 12 cm 11-310-12 TC  
 11-310-15 15 cm  
 11-312-12 12 cm Straight/recta



**REYNOLDS**

11-320-15 15 cm 11-321-15  
 11-321-18  
 11-321-15 TC

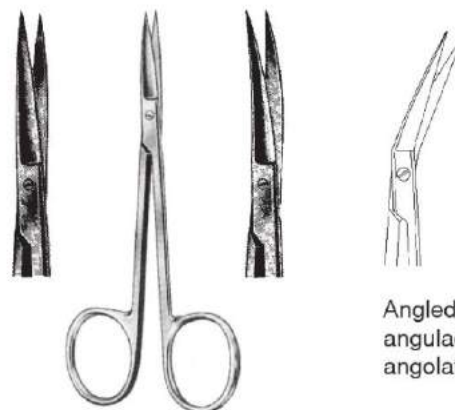

**IRIS**

11-340-09 9 cm 11-341-09 11-346-11 11 cm  
 11-340-10 10 cm 11-341-10  
 11-340-11 11 cm 11-341-11  
 11-340-11 TC 11-341-11 TC

Angled  
 angulada  
 angolata



Operating Scissors  
Tijeras para cirugía

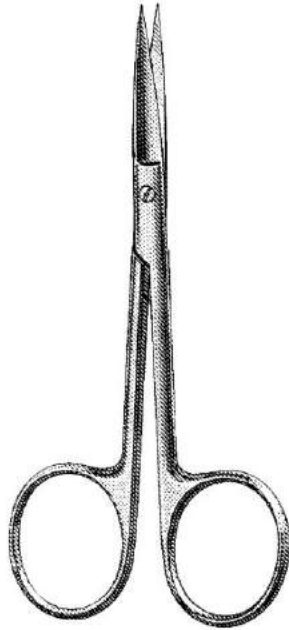

KNAPP  
10 cm, 4"  
11-348-01 11-348-02

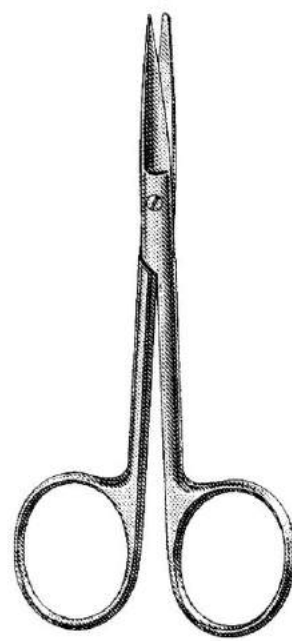

KNAPP  
10 cm, 4"  
11-348-03 11-348-04

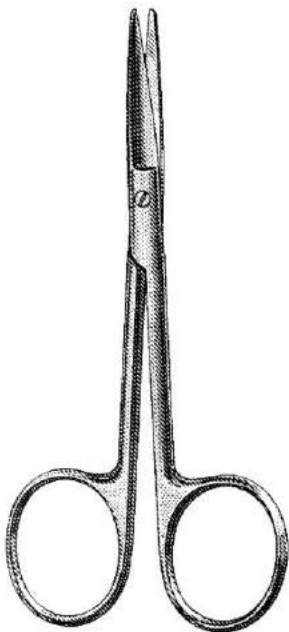

KNAPP  
10 cm, 4"  
11-348-05 11-348-06

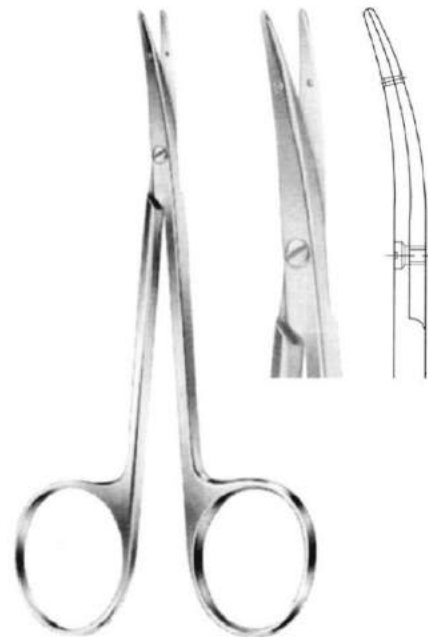

LITTLER  
12 cm, 4 3/4"  
11-349-12

Operating Scissors  
Tijeras para cirugía

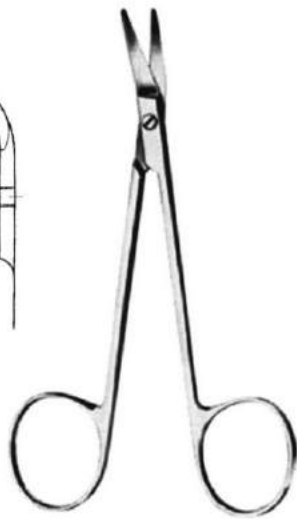
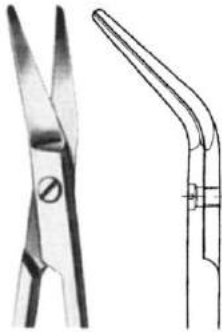

GRAEFE  
11-350-10  
10 cm  
4"

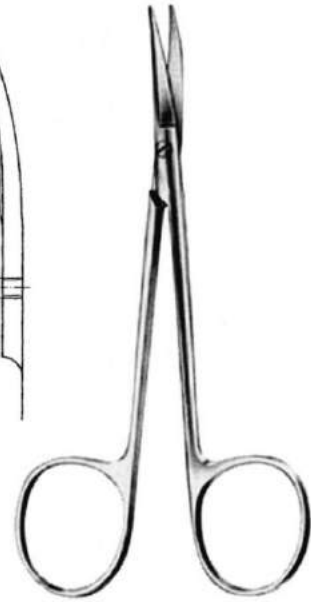
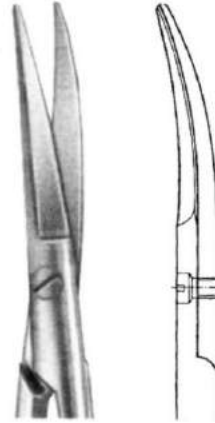

COTTLE  
11-358-11  
11.5 cm  
4 1/2"

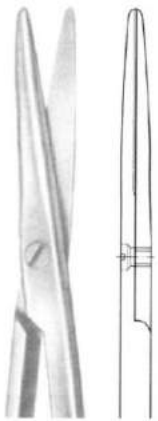

11-370-11  
11-370-11 TC



STRABISMUS  
11.5 cm, 4 1/2"



11-371-11  
11-371-11 TC

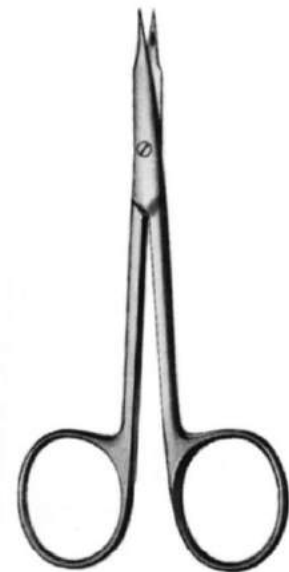

GRADLE  
11-365-09 9.5cm, 3.75"





## Ribbon Type Scissors Tijeras, oftalmología



**GRADLE**  
9.5 cm, 3 <sup>3</sup>/<sub>4</sub>"

Straight	Curved
rectas	curvas
retta	curva
11-350-09	11-351-09



**STEVENS** 9.5 cm, 3 <sup>3</sup>/<sub>4</sub>"

Straight	Curved
rectas	curvas
retta	curva
11-352-09	11-353-09



**IRIS** 10 cm, 4"

Straight	Curved
rectas	curvas
retta	curva
11-354-10	11-355-10



**UTILITY** 10cm, 4"

Straight	Curved
rectas	curvas
retta	curva
11-356-10	11-357-10



Scissors, Ophthalmology, Nasal  
Tijeras, oftalmología, nasales

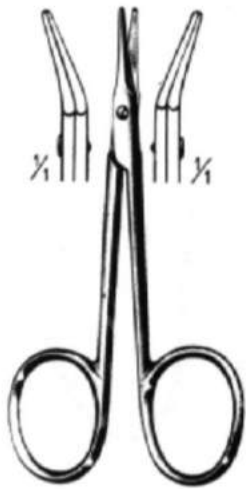

11-358-09    AEBLI    11-359-09  
9 cm    3 1/2"



11    STEVENS    11  
11 cm    4 3/8"

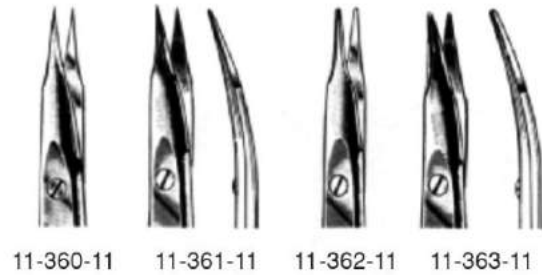

11-381-11    ENUCLEATION  
13 cm, 5 1/8"



11-400-15    HEYMAN  
KNIGHT Nasal Scissors  
Blunt 6.75

11-401-18    HEYMAN  
18 cm, 7"



11-403-15    FOMON  
15 cm, 6"



## Tonsil, Vascular Scissors Tijeras, amígdalas y vasculares



COTTLE  
11-405-16  
**11-405-16 TC**  
16 cm, 6 1/4"



DEAN  
11-425-17      11-427-17  
17 cm, 6 3/4"

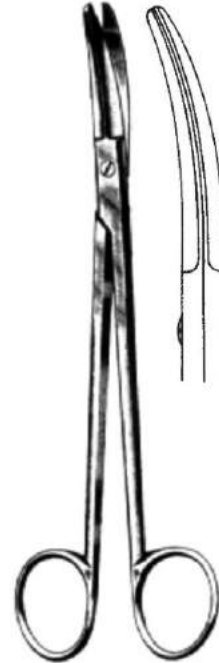

BOETTCHE  
11-435-18  
18 cm, 7"

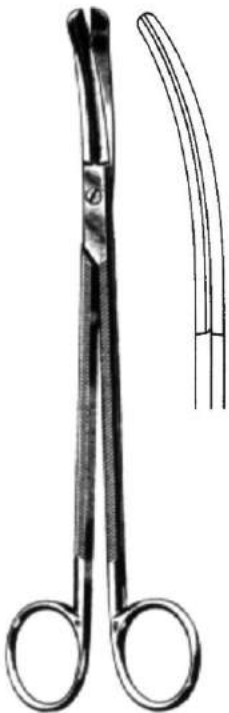

GOOD  
11-437-19  
19 cm, 7 1/2"

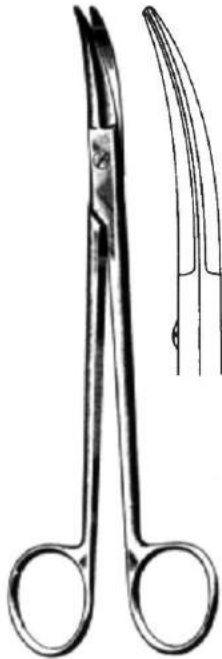

PRINCE  
11-439-17  
17 cm, 6 3/4"



11-468-15  
15 cm, 6"





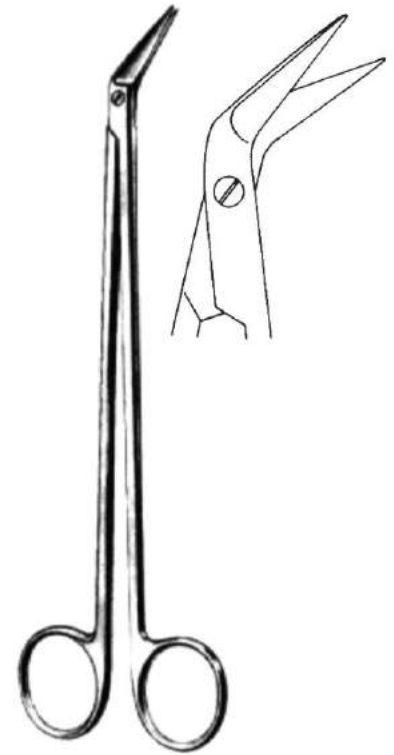





11-470-11  
11 cm, 4 3/8"









POTTS-DE MARTEL  
11-473-21  
21 cm, 8 1/4"

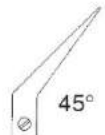
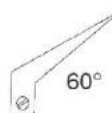

## Scissors, Thoracic and Vascular Tijeras, torácicas y vasculares

	25°	45°	60°		125°
					
	11-475-25 18 cm, 7"	11-475-45 18 cm, 7"	11-475-60 17.5 cm, 6.9"		
	90°	125°			
					
	11-475-90 17 cm, 6 3/4"	11-475-00 17 cm, 6 3/4"			
<p>DIETHRICH 11-475-25 to 11-475-00 17 cm, 6 3/4"</p>			<p>DIETHRICH 11-477-01 17 cm, 6 3/4"</p>		

## Scissors with Tungsten Carbide Tijeras con carburo de tungsteno Forbici con carburo di tungsteno

	25°	45°	60°
			
	11-478-25 19 cm 7 1/2"	11-478-45 19 cm 7 1/2"	11-478-60 19 cm 7 1/2"
	25°	45°	60°
			
	11-479-25 23 cm 9"	11-479-45 23 cm 9"	11-479-60 23 cm 9"

DE BAKEY  
(Potts-Smith)



Vascular Scissors  
Tijeras vasculares



**POTTS-SMITH**  
19 cm, 7 1/2"

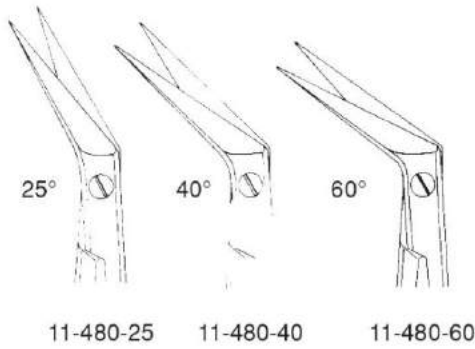

11-480-25    11-480-40    11-480-60

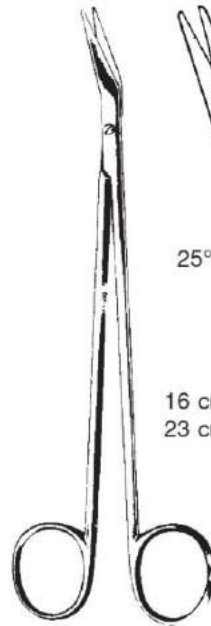

**DE BAKEY**

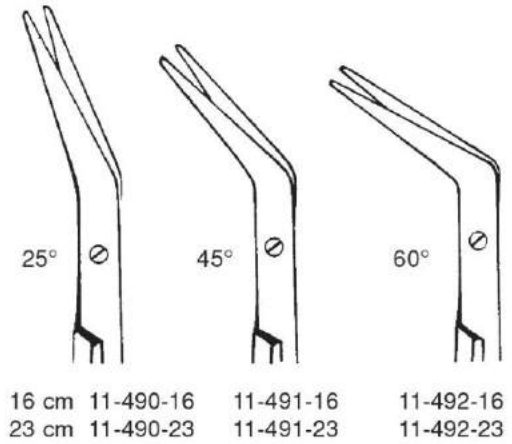

16 cm 11-490-16    11-491-16    11-492-16  
23 cm 11-490-23    11-491-23    11-492-23

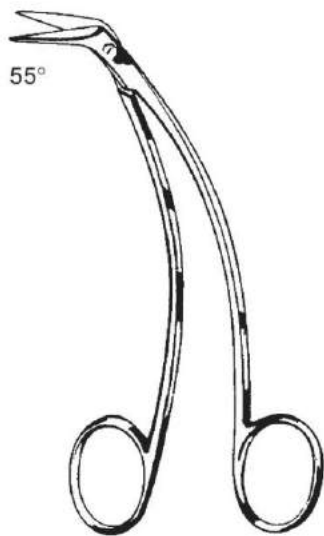

**FAVALORO**  
11-496-15    15 cm, 6"

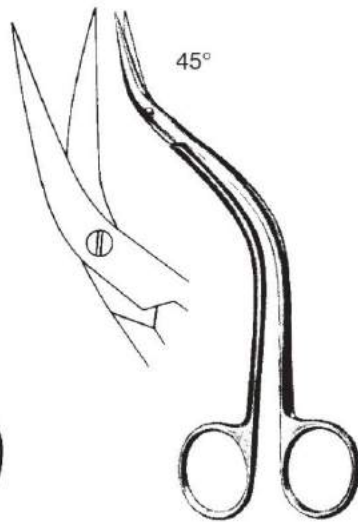

**DE BAKEY**  
11-497-15    15.5 cm, 6"



**KELLY**  
11-540-16    11-541-16  
11-540-16 TC    11-541-16 TC  
16 cm, 6 1/4"

Gynecological Scissors  
Tijeras ginecológicas



11-512-20  
11-512-23



11-513-20  
11-513-23



11-514-20  
11-514-23



11-515-20  
11-515-23

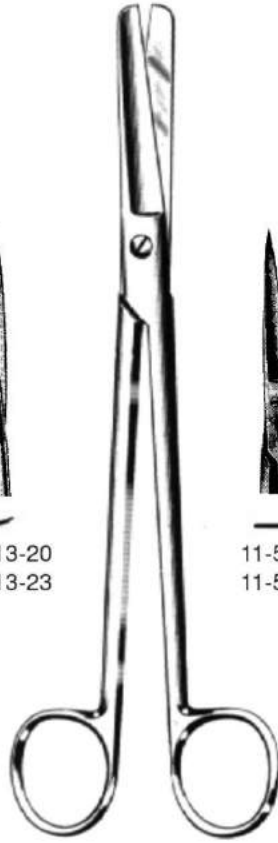

SIMS  
11-510-20 20 cm, 8" 11-511-20  
11-510-23 23 cm, 9" 11-511-23



WERTHEIM  
11-521-14  
14.5cm, 5.5"

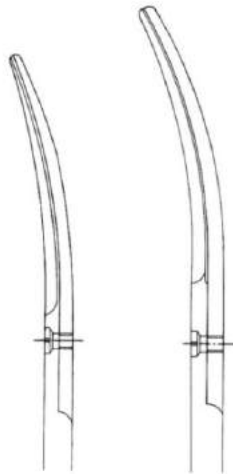

11-521-20 20 cm, 8"  
11-521-22 22cm, 8.5"

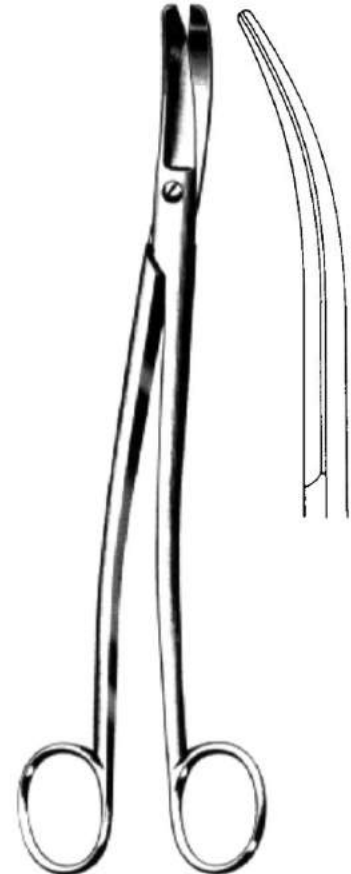

SIEBOLD  
11-523-24 24 cm, 9 1/2"



## Gynecological Scissors Tijeras ginecológicas

Parametrium



11-501-22 22.5 cm, 8.9"  
11-501-22 TC 22.5 cm, 8.9"

11-501-23 23 cm, 9"  
11-501-23 TC 23 cm, 9"

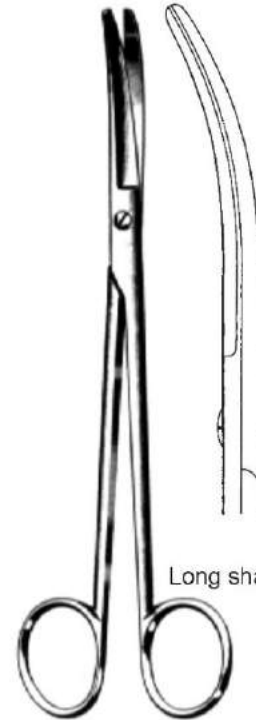

Long shank

WERTHEIM

11-525-19 19 cm, 7 1/2"  
11-525-22 22.5 cm, 8.9"  
11-525-25 25 cm, 10"



DOYEN

11-530-17 11-531-17  
17.5 cm, 6.9"

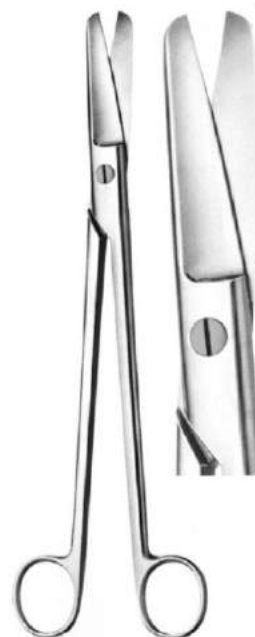

DUBOIS

11-536-27 11-537-27  
27 cm, 10 1/2"

## Operating Scissors Tijeras para cirugía



**WALDMAN**  
11-548-18  
18 cm, 7"



**U.S.A. Model**  
11-550-10  
10.5 cm, 4"



**BUSCH**  
11-551-16  
16 cm, 6 1/4"



**SCHUMACHER**  
11-553-16  
16 cm, 6 1/4"



**BRAUN-STADLER**  
11-560-14 14.5 cm, 5 3/4"  
11-560-22 22.0 cm, 8 3/4"



11-580-11 11-581-11  
11 cm, 4 3/8"



11-582-15 11-583-15  
15 cm, 6"

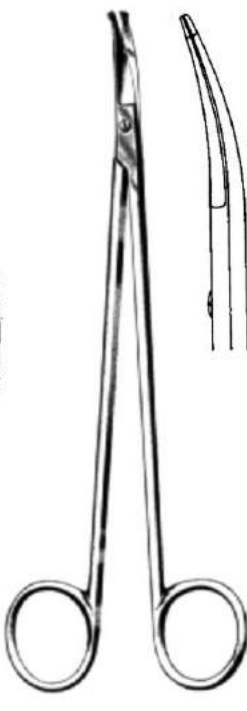

**STRULLY**  
11-601-22  
22 cm, 8 3/4"



**TOENNIS-ADSON**  
11-610-18  
18 cm, 7"

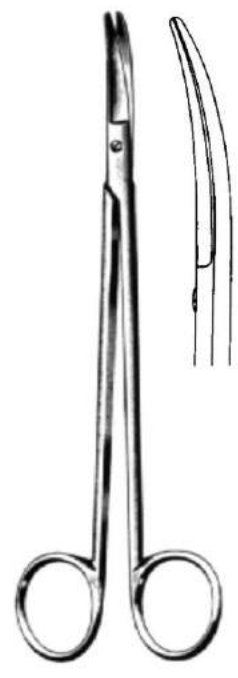

**TOENNIS-ADSON**  
11-611-18  
18 cm, 7"





Operating Scissors  
Tijeras para cirugía



McINDOE  
11-614-19  
19 cm, 7 1/2"



FOMON  
11-617-13  
13 cm, 5 1/8"



SCHMIEDEN-TAYLOR  
11-619-17  
17 cm, 6 3/4"

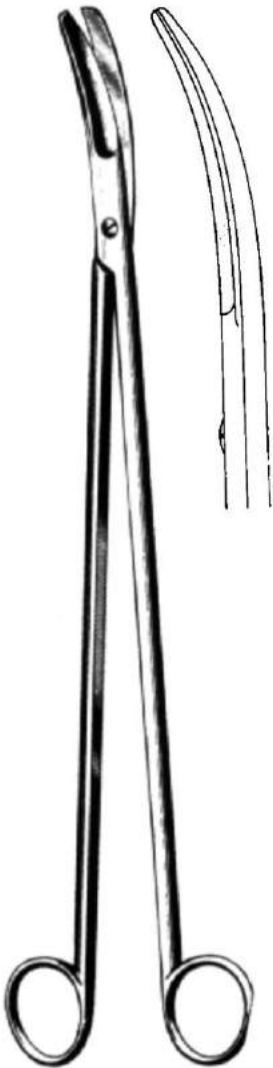

CRAFOORD  
11-641-30  
30 cm, 11 3/4"

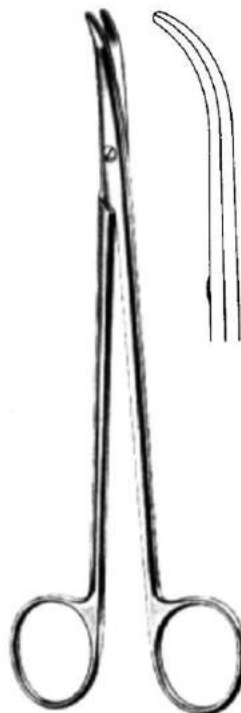

THOREK  
11-643-19 19 cm, 7 1/2"  
11-643-25 25 cm, 10"

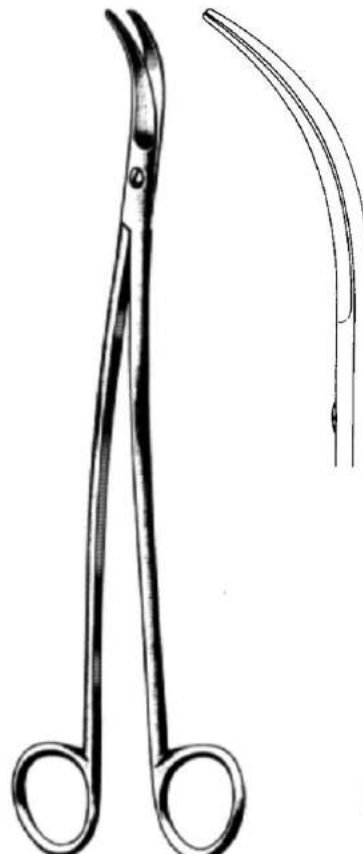

SATINSKY  
11-651-24  
24.5 cm, 9 1/2"

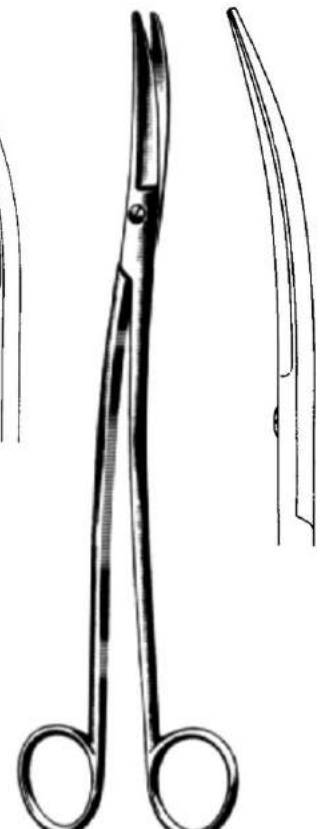

KLINKENBERGH-LOTH  
11-661-23  
23 cm, 9"



Operating Scissors  
Tijeras para cirugía

Enterotomy Scissors  
Enterótomos  
Forbici per enterotomia



FERGUSSON  
11-770-18  
18 cm, 7"



11-772-21  
21 cm, 8 1/4"



11-774-21  
21 cm, 8 1/4"



SISTRUNK  
11-775-13  
13 cm, 5 1/8"

11-800-09  
OBRIEN Stich  
Scissors Angled



SPENCER  
11-802-09  
9 cm, 3 1/2"



LITTAUER Jr.  
11-802-11  
11 cm, 4 3/8"



SHORTBENT  
NORTHBENT  
11-803-09 9 cm, 3 1/2"  
11-803-13 13 cm, 5 1/8"



LITTAUER  
11-804-14  
14 cm, 5 1/2"



HEATH  
11-809-15  
15 cm, 6"



## Operating Scissors Tijeras para cirugía

Gum Scissors  
Tijeras para encías  
Forbici gengivali

Serrated  
hoja dentada  
taglio della lama dentellato

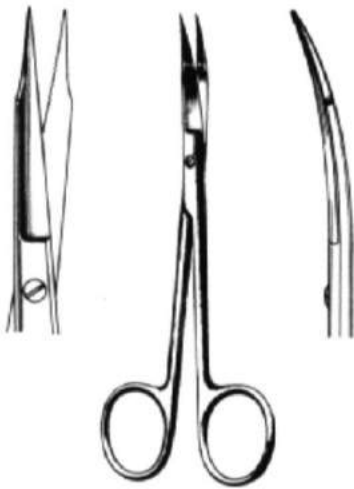

**GOLDMAN-FOX**  
11-820-13 13 cm, 5 1/8" 11-821-13



**WAGNER**  
12 cm, 4 3/4"

Straight  
rectas  
rette



BL/BL  
11-828-12



SH/BL  
11-826-12



SH/SH  
11-824-12

Curved  
curvas  
curve



BL/BL  
11-823-12



SH/BL  
11-829-12



SH/SH  
11-825-12

Wire Scissors  
Tijeras para alambre y láminas  
Forbici per filo di metallo e lamiera



**QUIMBY**  
11-827-12 12 cm, 4 3/4"



**UNIVERSAL**  
11-831-12 12 cm, 4 3/4"  
11-831-12 TC 12 cm, 4 3/4"



BEEBEE Crown Scissors  
Beebe Tijeras para coronas



BEEBEE

11-850-10  
Straight 10.5 cm, 4" Sharp  
rectas  
rette

11-852-10  
Straight 10.5 cm, 4" Blunt  
rectas  
rette

11-851-10  
Curved 10.5 cm, 4" Sharp  
curvas  
curve

11-853-10  
Curved 10.5 cm, 4" Blunt  
curvas  
curve

Gum Scissors  
Tijeras para encias  
Forbici gengivali



11-859-16  
Straigh Shank

LOCKLIN  
11-860-16  
16.5 cm, 6 1/2"  
Serrated  
dentadas  
dentellata



LOCKLIN  
11-860-16 TC  
16.5 cm, 6 1/2"



## Bandage Scissors Tijeras para vendajes

Gauze  
Gaza  
Garza



SMITH US ARMY  
11-898-20  
20 cm, 8"



LISTER  
9 cm, 3 1/2" 11-901-09  
11 cm, 4 3/8" 11-901-11  
14 cm, 5 1/2" 11-901-14  
18 cm, 7" 11-901-18  
20 cm, 8" 11-901-20



LISTER  
11-906-18 18 cm, 7"  
11-906-20 20 cm, 8"



BERGMAN  
11-911-23  
23 cm, 9"



ESMARCH  
11-913-20 20 cm, 8"  
11-913-22 22 cm, 8 3/4"



SEUTIN  
11-915-23  
23 cm, 9"



HERCULES  
11-921-16 16 cm, 6 1/4"  
11-921-19 19 cm, 7 1/2"  
Serrated  
dentadas  
dentellata

Bandage and Utility Scissors  
Tijeras para vendajes



KNOWLES  
11-930-14  
14 cm, 5 1/2"



KNOWLES  
11-931-14  
14 cm, 5 1/2"



LORENZ  
11-933-23  
23 cm, 9"



BRUNS  
11-935-23 23 cm, 9" **11-935-23 TC**  
11-937-23 23 cm, 9"  
With Teeth



FIRST AID  
11-941-20  
20 cm, 8"



UNIVERSAL  
11-950-15 15 cm, 6"  
11-950-18 18 cm, 7"



## SUPERCUT SCISSORS - Scalpel Like Upper Blade - Micro Serrated Lower Blade Tijeras Supercut



Standard OPERATING Sharp/Blunt  
14.5 cm, 5 3/4"

Straight	Curved
rectas	curvas
rette	curve
11-110-14SC	11-111-14SC



MAYO

Straight	Curved
rectas	curvas
rette	curve
11-160-14SC	11-161-14
11-160-17SC	11-161-17
11-160-23SC	11-161-23



MAYO-STILLE

Straight	Curved
rectas	curvas
rette	curve
11-170-15SC	11-171-15SC
11-170-17SC	11-171-17SC



BABY METZENBAUM  
11.5 cm, 4 1/2"

Straight	Curved
rectas	curvas
rette	curve
11-280-12SC	11-281-12SC



METZENBAUM

Straight	Curved
rectas	curvas
rette	curve
11-280-14SC	11-281-14SC
11-280-18SC	11-281-18SC
11-280-20SC	11-281-20SC
11-280-23SC	11-281-23SC



## SUPERCUT SCISSORS - Scalpel Like Upper Blade - Micro Serrated Lower Blade Tijeras Supercut



**IRIS**  
11.5 cm, 4 1/2"

Straight	Curved
rectas	curvas
rette	curve
11-340-11SC	11-341-11SC



**WAGNER**  
12 cm, 4 3/4"

Straight	Curved
rectas	curvas
rette	curve
11-824-12SC	11-825-12SC



**STEVENS**  
11.5 cm, 4 1/2"

Straight	Curved
rectas	curvas
rette	curve
11-362-11SC	11-363-11SC



**LISTER**  
11-901-14SC 14.5 cm, 5 3/4"  
11-901-18SC 18.0 cm, 7"



**REYNOLDS**  
11-320-15SC 15 cm, 6"



**KILNER/RAGNELL**  
11-310-12SC 12 cm, 4 3/4"





Face Lift Scissors  
Tijeras Face Lift

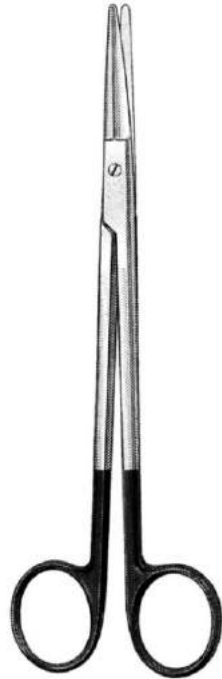

**GORNEY FACE LIFT**  
19 cm, 7 1/2"



12-010-19  
**12-010-19TC**  
12-010-19SC



12-011-19  
**12-011-19TC**  
12-011-19SC



**REES FACE LIFT**

- 12-016-17 — 17.0 cm, 6 3/4"
- 12-017-17 — 17.0 cm, 6 3/4"
- 12-018-20 — 20.5 cm, 8"
- 12-019-20 — 20.5 cm, 8"

TC (Add TC)

- 12-016-17** — 17.0 cm, 6 3/4"
- 12-017-17** — 17.0 cm, 6 3/4"
- 12-018-20** — 20.5 cm, 8"
- 12-019-20** — 20.5 cm, 8"

Supercut (Add SC)

- 12-016-17 — 17.0 cm, 6 3/4"
- 12-017-17 — 17.0 cm, 6 3/4"
- 12-018-20 — 20.5 cm, 8"
- 12-019-20 — 20.5 cm, 8"

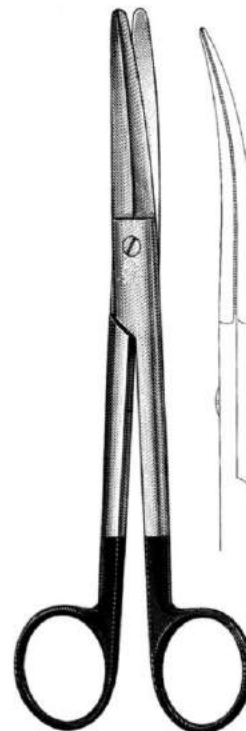

**KAYE FACE LIFT**

TC (Add TC)

- 12-028-14** — 14.5 cm, 5 3/4"
- 12-029-14** — 14.5 cm, 5 3/4"
- 12-030-18** — 18.5 cm, 7 1/4"
- 12-031-18** — 18.5 cm, 7 1/4"
- 12-032-23** — 23.0 cm, 9"
- 12-033-23** — 23.0 cm, 9"

Supercut (Add SC)

- 12-028-14 — 14.5 cm, 5 3/4"
- 12-029-14 — 14.5 cm, 5 3/4"
- 12-030-18 — 18.5 cm, 7 1/4"
- 12-031-18 — 18.5 cm, 7 1/4"
- 12-032-23 — 23.0 cm, 9"
- 12-033-23 — 23.0 cm, 9"



Face Lift Scissors  
Tijeras Face Lift

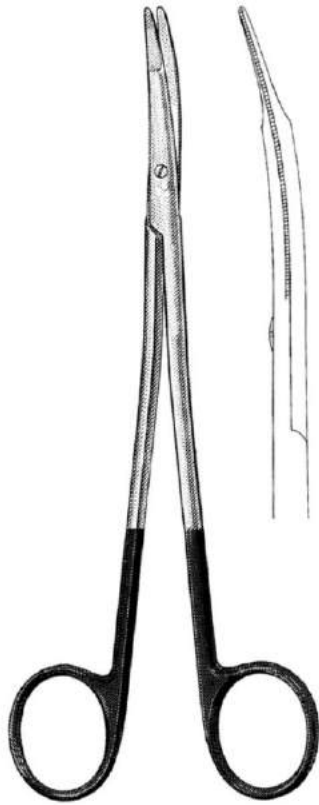

- 12-040-18 18 cm, 7"
- 12-040-18TC** 18 cm, 7"
- 12-040-18SC 18 cm, 7"

FREEMAN Face Lift



- 12-044-14 Straight 14.5 cm, 5 3/4"
- 12-045-14 Curved 14.5 cm, 5 3/4"
- 12-044-14TC** Straight 14.5 cm, 5 3/4"
- 12-045-14TC** Curved 14.5 cm, 5 3/4"
- 12-044-14SC Straight 14.5 cm, 5 3/4"
- 12-045-14SC Curved 14.5 cm, 5 3/4"

PECK-JOSEPH



Ophthalmic Scissors  
Tijeras oculares



WESTCOTT  
12-102-11  
11 cm, 4 3/8"



WESTCOTT  
12-104-11  
11 cm, 4 3/8"



NOYES  
12-110-12 12-111-12  
12 cm, 4 3/4"



DEWECKER  
11 cm, 4 3/8"



12-113-11



12-115-11



12-117-11

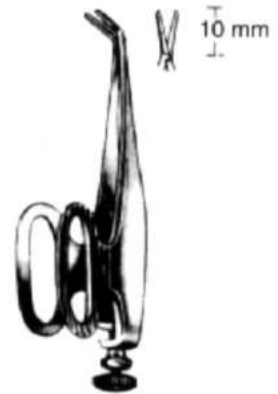

BARRAQUER  
12-119-10 5.5 cm, 2.2"  
(Colibri)



Micro Scissors  
Micro Tijeras



12-120-16  
12-120-18  
12-120-22

16.0 cm, 6 1/4"  
18.5 cm, 7 1/4"  
22.5 cm, 8.9"



12-121-16  
12-121-18  
12-121-22



12-122-16  
12-122-18  
12-122-22

16.0 cm, 6 1/4"  
18.5 cm, 7 1/4"  
22.5 cm, 8.9"



12-123-16  
12-123-18  
12-123-22



12-124-16  
12-124-18  
12-124-22

16.0 cm, 6 1/4"  
18.5 cm, 7 1/4"  
22.5 cm, 8.9"



12-125-16  
12-125-18  
12-125-22

Circumflex



25°

12-126-25

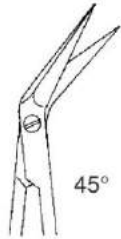

45°

12-126-45

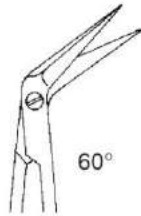

60°

12-126-60



25°

12-127-25



45°

12-127-45

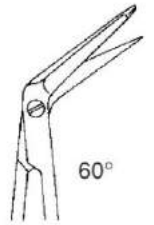

60°

12-127-60

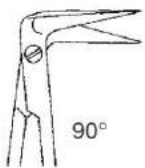

90°

12-126-90

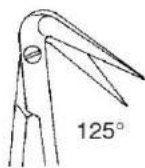

125°

12-126-00

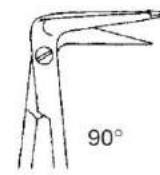

90°

12-127-90



125°

12-127-00



18 cm, 7"



## Micro Scissors Micro Tijeras



12-128-09  
9 cm, 3 1/2"



12-128-15 15 cm, 6"  
Straight  
rectas  
rette

12-129-15 15 cm, 6"  
Curved  
curvas  
curvo

12-130-15 15 cm, 6"  
Curved, Serrated Blade  
curvas, hoja dentada  
curva, lama dentellata

12-128-15 to 12-130-15  
15 cm, 6"

## Semi-Sharp lame semi smusse



Hepp-Scheidel  
12-131-14 14 cm, 5 1/2"  
12-131-16 16 cm, 6 1/4"



Hepp-Scheidel  
12-132-18  
18 cm, 7"



Hepp-Scheidel  
12-137-01  
18 cm, 7"  
Sharp  
agudas  
acute

Hepp-Scheidel  
12-137-02  
18 cm, 7"  
Blunt  
romas  
smusse



Iridectomy, Iridectomía, iridectomia

Ophthalmic, Micro Scissors  
Tijeras oculares, microquirúrgicas



CASTROVIEJO  
12-133-10 10 cm, 4"



CASTROVIEJO  
12-135-10 10 cm, 4"



VANNAS  
12-140-08 8 cm, 3 1/8"



VANNAS  
12-141-08 8 cm, 3 1/8"



12-142-08  
Angled on Flat

12-143-08  
Angled Up

Corneal Scissors, Tijeras corneales, Forbici corneali



CASTROVIEJO  
12-151-11 11 cm, 4 3/8"



CASTROVIEJO  
12-153-11 11 cm, 4 3/8"



CASTROVIEJO  
12-155-11 11 cm, 4 3/8"



Micro Scissors  
Micro Tijeras



BARRAQUER

Straight	Curved
12-202-18	12-203-18
18 cm, 7"	



12-313-14  
14 cm  
5 1/2"



12-313-16  
16 cm  
6 1/4"



12-330-19 to 12-333-19  
18.5 cm, 7 1/4"



12-330-19



12-331-19



12-333-19

Micro  
12-320-09  
9 cm, 3.5"





## Dressing and Tissue Forceps Pinzas de disección, sin/con dientes

cm		USA	STILLE	Narrow SS	TC	POTTS-SMITH SS	TC	POTTS-SMITH 1X2
10.5	14-102-10							
11.5	14-102-11				14-110-11			
12.0		14-104-12						
13.0	14-102-13	14-104-13	14-106-13	14-110-13				
14.5	14-102-14	14-104-14		14-110-14	14-110-14			
15.0			14-106-15					
15.5		14-104-15						
16.0	14-102-16			14-110-16	14-110-16 TC			
18.0	14-102-18	14-104-18		14-110-18		14-112-18	14-112-18 TC	14-126-18
20.0	14-102-20			14-110-20				
21.0		14-104-21				14-112-21	14-112-21 TC	14-126-21
25.0	14-102-25	14-104-25		14-110-25	14-110-20 TC	14-112-25	14-112-25 TC	14-126-25
30.0	14-102-30			14-110-30	14-110-25 TC			

cm		USA	STILLE	Narrow	OEHLER	2x3	3x4	4x5
10.5	14-120-10							
11.5	14-120-11					14-140-11		
12.0		14-122-12						
13.0	14-120-13	14-122-13		14-130-13		14-140-13	14-150-13	14-160-13
14.5	14-120-14	14-122-14		14-130-14		14-140-14	14-150-14	14-160-14
15.0			14-124-15					
15.5		14-122-15						
16.0	14-120-16			14-130-16	14-132-16 TC	14-140-16	14-150-16	14-160-16
18.0	14-120-18	14-122-18		14-130-18	14-132-18 TC	14-140-18		
20.0	14-120-20			14-130-20	14-132-20 TC	14-140-20		
21.0		14-122-21						
25.0	14-120-25	14-122-25			14-132-25 TC	14-140-25		
30.0	14-120-30				14-132-30 TC			



## Dressing and Tissue Forceps Pinzas de disección, sin/con dientes



HUDSON  
14-170-12  
12 cm, 4 3/4"  
14-170-15  
15 cm, 6"



ADSON  
14-174-12 TC  
12 cm, 4 3/4"  
14-174-15 TC  
15 cm, 6"



ADSON 1mm  
14-176-12  
12 cm, 4 3/4"  
14-176-15  
15 cm, 6"



ADSON Atraumatic  
14-177-12  
12 cm, 4 3/4"



ADSON  
14-178-12  
12 cm, 4.75"



HUDSON  
14-180-12  
12 cm, 4 3/4"  
14-180-15  
15 cm, 6"



ADSON  
14-179-12  
12 cm, 4 3/4"

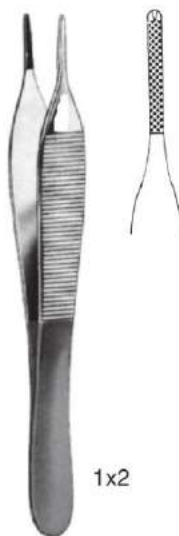

ADSON  
14-181-12 TC  
12 cm, 4 3/4"  
14-181-15 TC  
15 cm, 6"

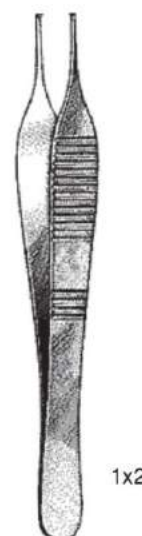

ADSON 1mm  
14-186-12  
12 cm, 4 3/4"  
14-186-15  
15 cm, 6"



ADSON  
14-187-12  
12 cm, 4 3/4"



## Dressing and Tissue Forceps Pinzas de disección, sin/con dientes



7x7

### ADSON-BROWN

- 14-188-12 12 cm, 4 3/4"
- 14-188-15 15 cm, 6"
- 14-188-12 TC** 12 cm, 4 3/4"



9x9

### BROWN

- 14-189-15 15 cm, 6"
- 14-189-20 20 cm, 8"
- 14-189-25 25 cm, 10"



### GRAEFE

- 14-190-10 10.5 cm, 4.25"



1x2

### WAUGH

- 14-187-18 18 cm, 7"
- 14-187-20 20 cm, 8"
- 14-187-25 25 cm, 10"
- 14-187-30 30 cm, 11 3/4"



17 cm  
6 3/4"

### CUSHING

- 14-220-17
- 14-220-17 TC**

14-221-17



17 cm  
6 3/4"

### CUSHING

- 14-222-17
- 14-222-17 TC**

14-223-17

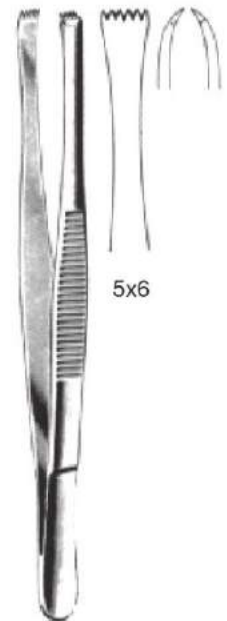

5x6

### LERCHE

- 14-232-15
- 15 cm, 6"



## Dressing and Tissue Forceps Pinzas de disección, sin/con dientes

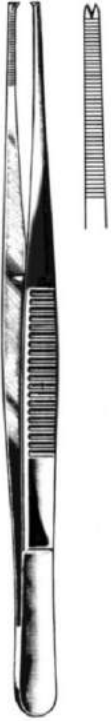

**BROPHY**  
14-231-20  
20 cm, 8"



**BROPHY**  
14-233-20  
20 cm, 8"



14-234-20



14-235-20

**BROPHY**



4x5

**ADLERKREUTZ**  
14-236-15 15 cm, 6"  
14-236-20 20 cm, 8"



1x2

**LANE**  
14-240-14  
14.5 cm, 5 3/4"



2x3

**LANE**  
14-242-14  
14.5 cm, 5 3/4"



1x2

**FERRIS-SMITH**  
14-246-18  
18 cm, 7"



2x3 T

**FERRIS-SMITH**  
14-248-18  
18 cm, 7"



## Dressing and Tissue Forceps Pinzas de disección, sin/con dientes



DUVAL  
14-250-14  
14.5 cm, 5 3/4"



COLLIN-DUVAL  
14-252-20  
20 cm, 8"



RUSSIAN  
14-256-15 15 cm, 6"  
14-256-20 20 cm, 8"  
14-256-25 25 cm, 10"



McINDOE  
14-257-15  
15 cm, 6"



McINDOE  
14-258-15 15 cm, 6"  
14-258-15 TC 15 cm, 6"

## Dressing and Tissue Forceps Pinzas de disección, sin/con dientes



SEMKEN

- 14-260-12 12.5 cm, 5"
- 14-260-15 15.5 cm, 6"
- 14-260-15 TC 15.5 cm, 6"



1x2

SEMKEN

- 14-270-12 12.5 cm, 5"
- 14-270-15 15.5 cm, 6"
- 14-270-15TC 15.5 cm, 6"
- 14-270-18 TC 18 cm, 7"



1x2

GILLIES

- 14-272-15 15.5 cm, 6"
- 14-272-15 TC 15.5 cm, 6"



15.5 cm, 6"



14-274-06  
0.6 mm



14-274-08  
0.8 mm



14-274-10  
1.0 mm



GERALD

- 14-302-17 17.5 cm, 7"
- 14-302-23 23.0 cm, 9"
- 14-302-17 TC 17.5 cm, 7"



GERALD

- 14-303-17 17.5 cm, 7"



Dressing and Tissue Forceps  
Pinzas de disección, sin/con dientes



GERALD  
14-305-17  
17.5 cm, 7"



GERALD  
14-310-17 17.5 cm, 7"  
14-310-17 TC 17.5 cm, 7"



GERALD  
14-311-17  
17.5 cm, 7"



CUSHING-TAYLOR  
14-312-18 TC  
18.5 cm, 7 1/4"



GERALD  
14-313-17  
17.5 cm, 7"



14-314-01  
17 cm, 6 3/4"



14-314-02  
17 cm, 6 3/4"  
1x2



TAYLOR



14-315-01  
17 cm, 6 3/4"



14-315-02  
17 cm, 6 3/4"  
1x2

TAYLOR



## Dressing and Tissue Forceps Pinzas de disección, sin/con dientes

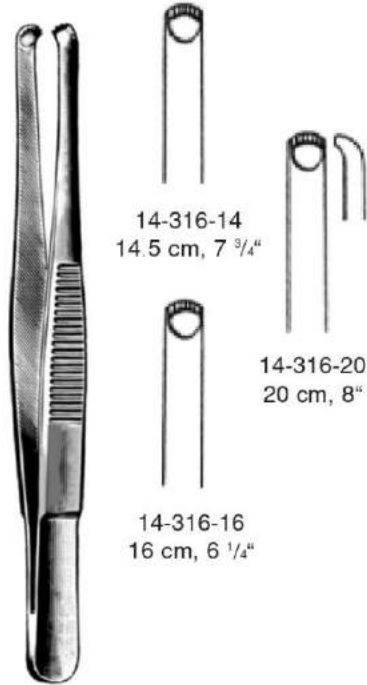

14-316-14  
14.5 cm, 7 3/4"

14-316-20  
20 cm, 8"

14-316-16  
16 cm, 6 1/4"

DURANTE

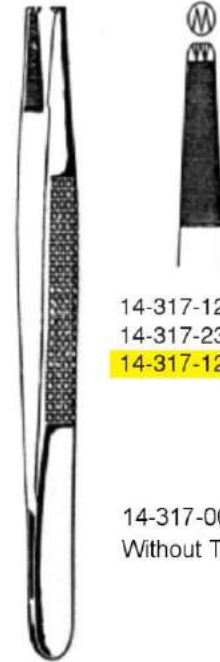

14-317-12 1x2  
14-317-23 2x3  
14-317-12 TC 1x2

14-317-00  
Without Teeth

BONNEY  
18 cm, 7"

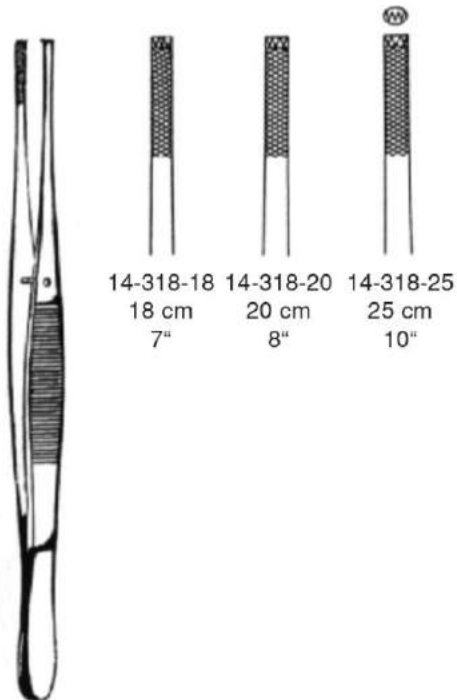

14-318-18 18 cm 7"  
14-318-20 20 cm 8"  
14-318-25 25 cm 10"

STILLE-BARRAYA  
3x4



SINGLEY  
14-320-18 7"  
14-320-23 9"



NELSON  
14-322-15 6"  
14-322-18 7"  
14-322-23 9"





## Dressing and Tissue Forceps Pinzas de disección, sin/con dientes

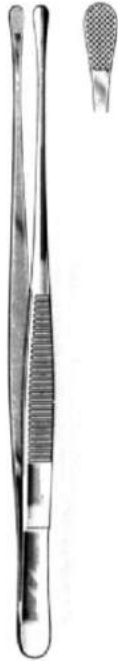

WANGENSTEEN  
14-324-23



14-325-15 TC  
15 cm, 6"

14-324-23 TC  
23 cm, 9"

14-325-25 TC  
25 cm, 10"

WANGENSTEEN



MAYO  
23 cm, 9"



14-326-23



STRASSBURGER

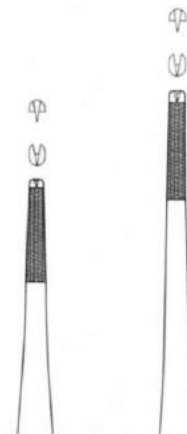

14-328-15  
15 cm, 6"

14-328-20  
20 cm, 8"



SWISS JEWELER Type Forceps  
Pinzas para espinas

1



14-401-01  
12 cm, 4 3/4"

3



14-403-03  
12 cm, 4 3/4"

3c



14-403-04  
11 cm, 4 3/8"

4



14-404-04  
11 cm, 4 3/8"

5



14-405-05  
11 cm, 4 3/8"

7



14-407-07  
12 cm, 4 3/4"



## Splinter Forceps Pinzas para espinas



Plain

- 14-802-09 9.0 cm, 3 1/2"
- 14-802-10 10.5 cm, 4"
- 14-802-11 11.5 cm, 4 1/2"



- FEILCHENFELD**
- 14-810-07 7.5 cm, 3"
  - 14-810-09 9.0 cm, 3 1/2"
  - 14-810-11 11.5 cm, 4 1/2"



- CARMALT**
- 14-812-10 10.5 cm, 4.25"

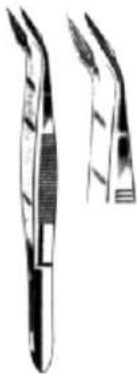

- CARMALT**
- 14-813-10 10.5 cm, 4.25"



- CARMALT**
- 14-815-12 12.5 cm, 5"



- WALTER**
- 14-816-10 10.5 cm, 4.25"



- WALTER**
- 14-817-10 10.5 cm, 4.25"

Splinter Forceps  
Pinzas para espinas



PEET  
14-821-11  
11.5 cm, 4 1/2"



STIEGLITZ  
14-822-13 14-823-13  
13.5 cm, 5 1/4"



ARCHER  
14-824-14 14-825-14  
14 cm, 5 1/2"



VIRTUS (RALK)  
14-828-15 14-829-15  
15 cm, 6"



Cotton Pliers  
Pinzas dentales

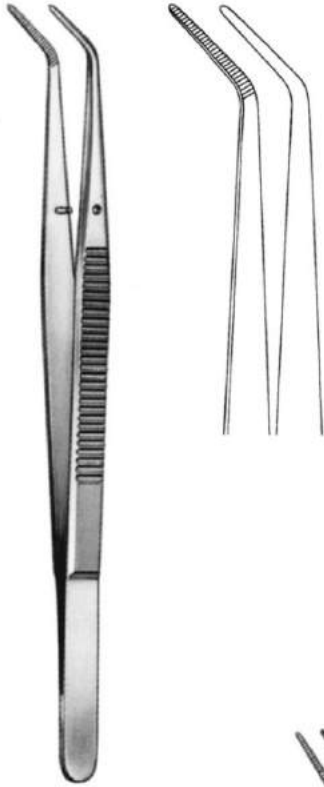

LONDON-COLLEGE  
16-900-01  
15 cm 6"

FENESTRATED HANDLES  
ANMUTH  
College Pliers  
16-880-15



MERIAM  
16-910-01  
15 cm 6"

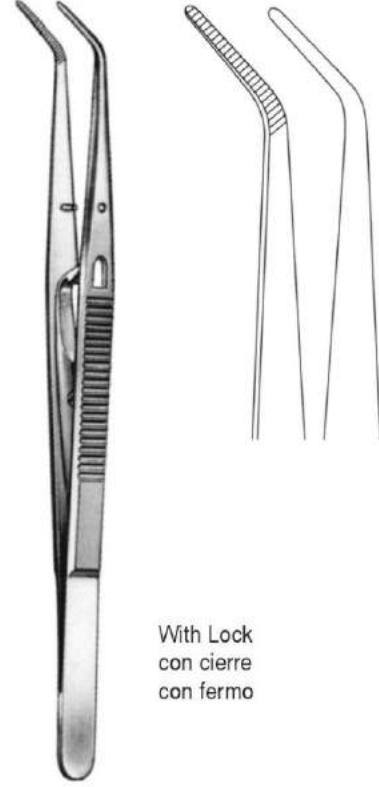

LONDON-COLLEGE  
16-901-05  
15 cm 6"

With Lock  
con cierre  
con fermo



Microsurgery Forceps, RHOTON  
Pinzas para microcirugía



16-102-12  
12 cm, 4 3/4"



16-103-12  
12 cm, 4 3/4"



16-104-15  
15 cm, 6"



16-105-15  
15 cm, 6"



16-108-18  
18 cm, 7"



16-109-18  
18 cm, 7"



Ultra Light Forceps  
Pinzas Ultra Ligera

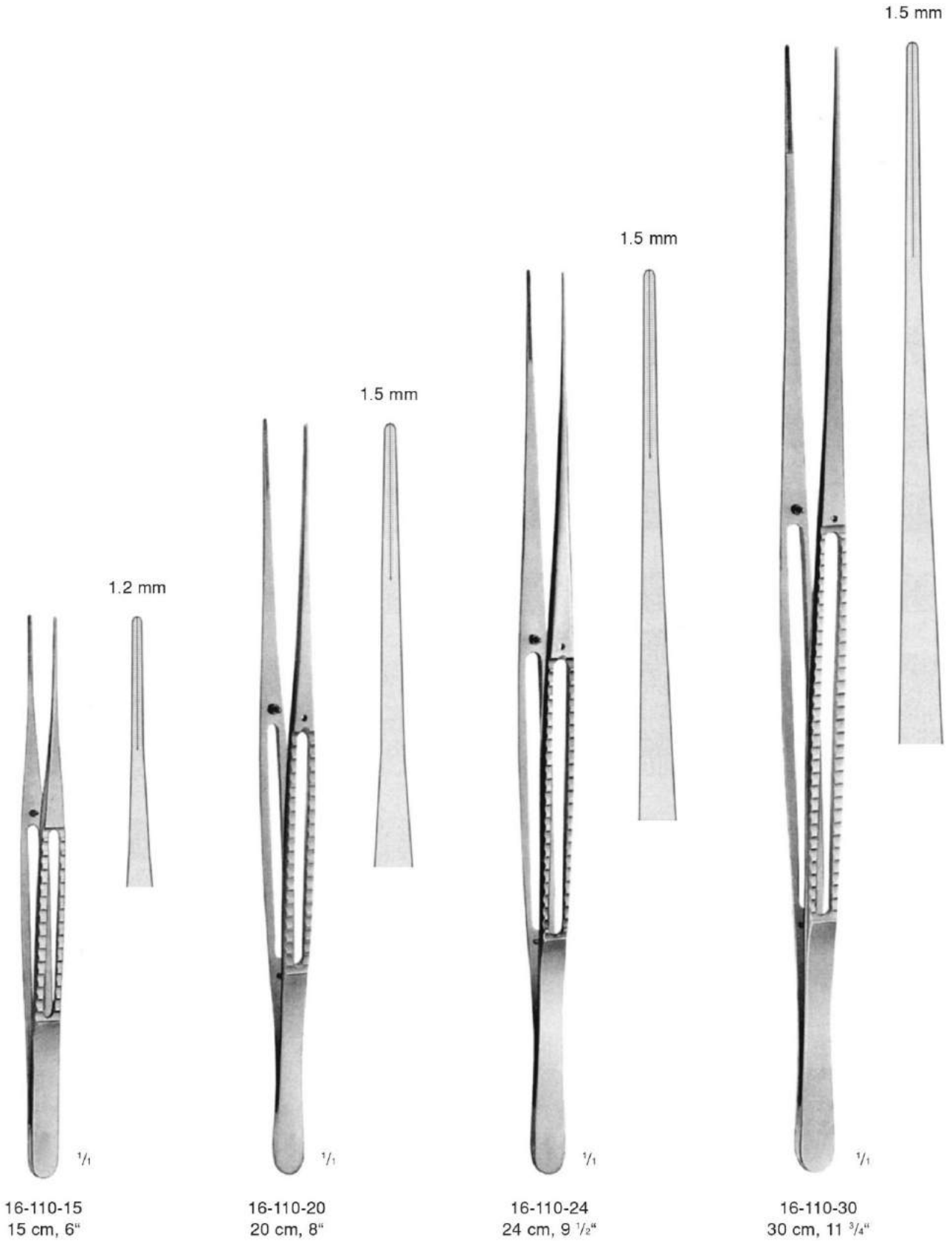



Microsurgery Forceps  
Pinzas para microcirugía

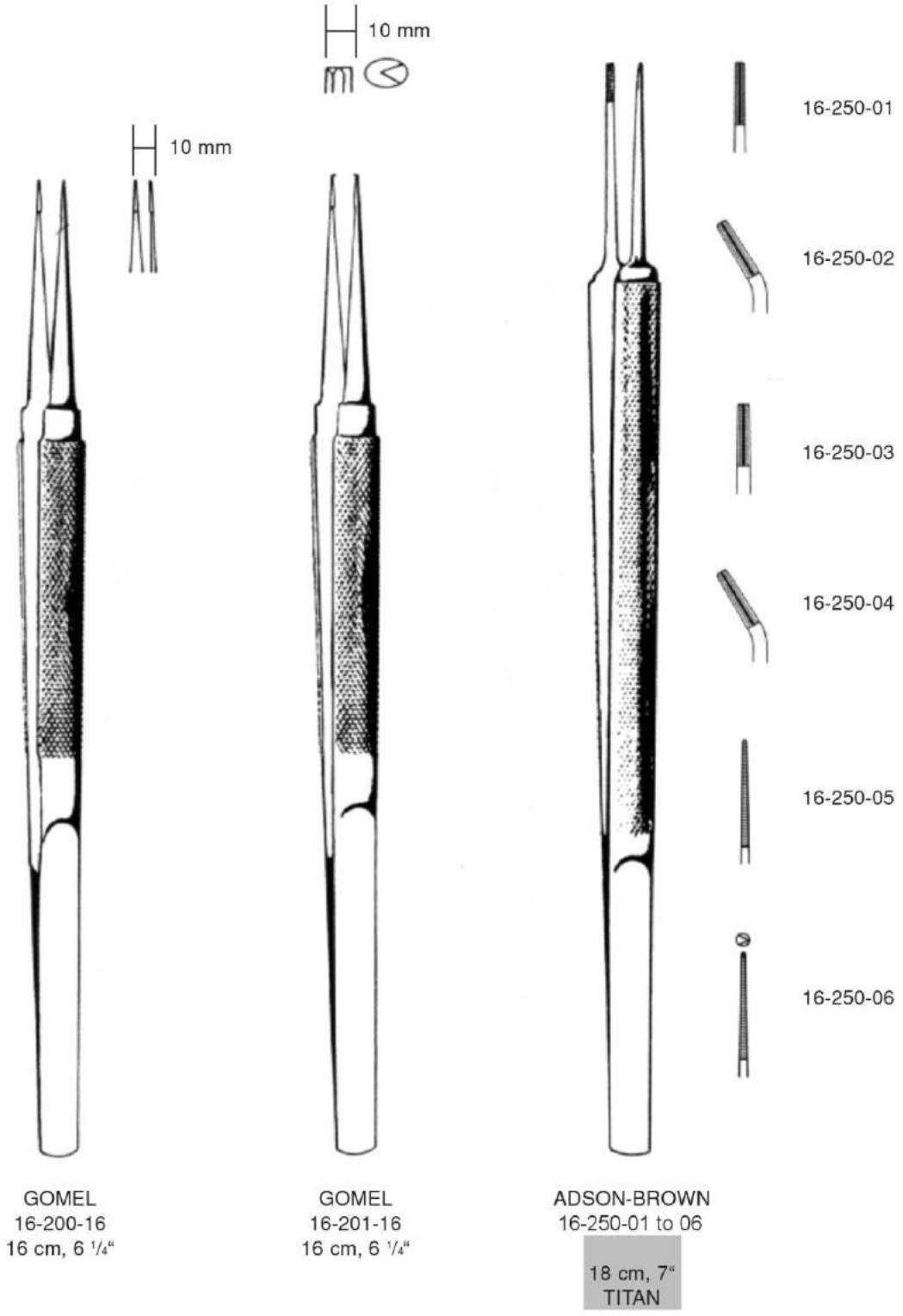

GOMEL  
16-200-16  
16 cm, 6 1/4"

GOMEL  
16-201-16  
16 cm, 6 1/4"

ADSON-BROWN  
16-250-01 to 06  
18 cm, 7"  
TITAN





VICKERS  
18 cm, 7"

	1.0 x 0.5 mm	1.0 x 0.5 mm	1.0 x 0.5 mm	1.0 x 0.5 mm
Mini				
	16-270-10	16-271-10	16-276-10	16-277-10
	2.0 x 1.0 mm	2.0 x 1.0 mm	2.0 x 1.0 mm	2.0 x 1.0 mm
Maxi				
	16-280-15	16-281-15	16-287-15	16-288-15

TITAN



Tumor Forceps  
Pinzas para tumores

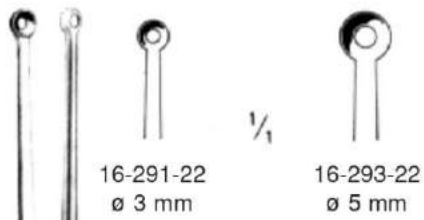

16-291-22  
ø 3 mm

16-293-22  
ø 5 mm

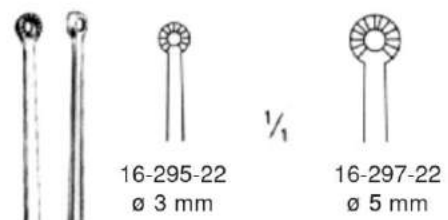

16-295-22  
ø 3 mm

16-297-22  
ø 5 mm



YASARGIL  
16-291-22 16-293-22  
22 cm, 8 3/4"



YASARGIL  
16-295-22 16-297-22  
22 cm, 8 3/4"



**Atraumatic Tissue Forceps  
Pinzas atraumáticas**



1 mm

**DE BAKEY**

- 16-302-16 16 cm, 6 1/4"
- 16-302-20 20 cm, 8"
- 16-302-24 24 cm, 9 1/2"



2.7 mm

**DE BAKEY**

- 16-304-16 16 cm, 6 1/4"
- 16-304-20 20 cm, 8"
- 16-304-24 24 cm, 9 1/2"
- 16-304-30 30 cm, 11 3/4"



1.5 mm

**DE BAKEY**

- 16-306-16 16 cm, 6 1/4"
- 16-306-20 20 cm, 8"
- 16-306-24 24 cm, 9 1/2"
- 16-306-30 30 cm, 11 3/4"



2.0 mm

**DE BAKEY**

- 16-308-16 16 cm, 6 1/4"
- 16-308-20 20 cm, 8"
- 16-308-24 24 cm, 9 1/2"
- 16-308-30 30 cm, 11 3/4"



2.0 mm

**DE BAKEY**

- 16-309-16 16 cm, 6 1/4"
- 16-309-20 20 cm, 8"
- 16-309-24 24 cm, 9 1/2"
- 16-309-30 30 cm, 11 3/4"



3.5 mm

**DE BAKEY**

- 16-310-16 16 cm, 6 1/4"
- 16-310-20 20 cm, 8"
- 16-310-24 24 cm, 9 1/2"
- 16-310-30 30 cm, 11 3/4"



1.5 mm

**DE BAKEY**

- 16-320-15  
15 cm  
6"

- 16-320-20  
20 cm  
8"

- 16-320-24  
24 cm  
9 1/2"

**TITAN**

1.5 mm

1.5 mm



## Atraumatic Bulldog Clamps Clamps Atrauma Bulldog

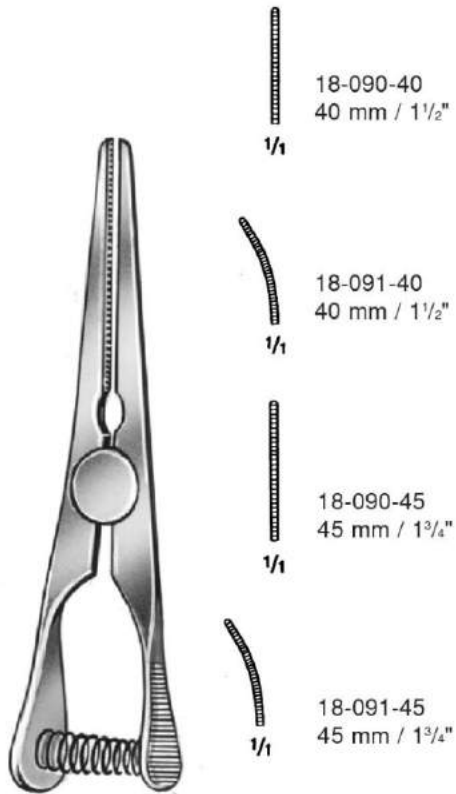

18-090-40  
40 mm  
1 1/2"

JACOBSON



18-091-50  
50 mm  
2"



18-098-06  
57 mm  
2 3/8"

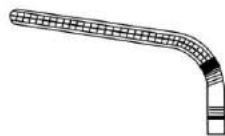

GLOVER



18-099-07  
73 mm  
2 3/4"



DE BAKEY



## Mini Bulldog Clamps Clamps Bulldog Mini

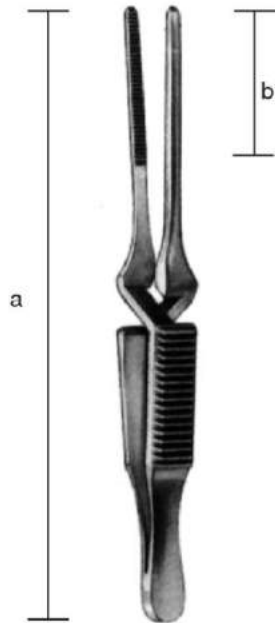



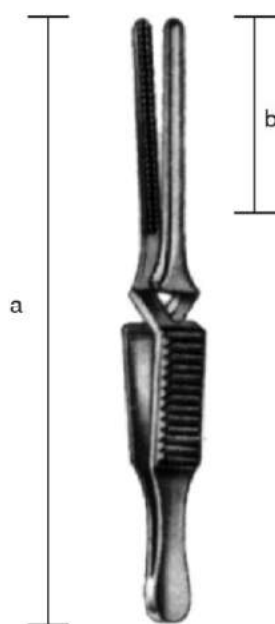
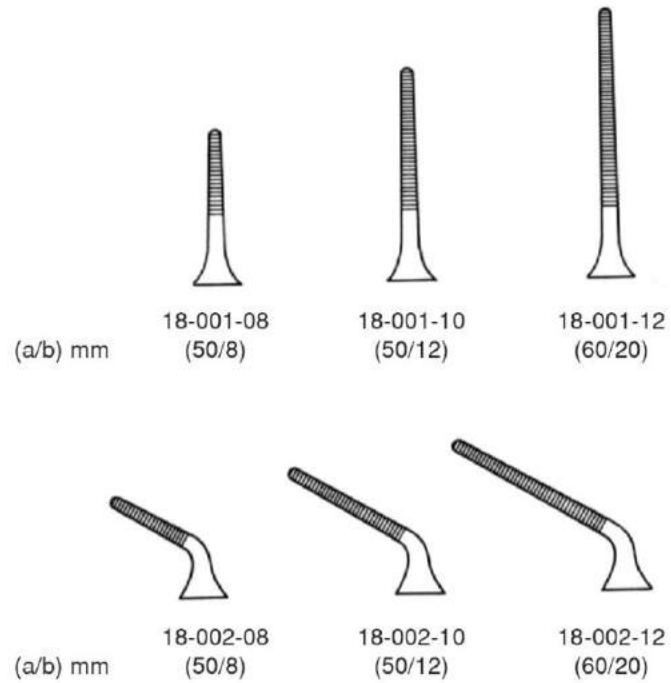

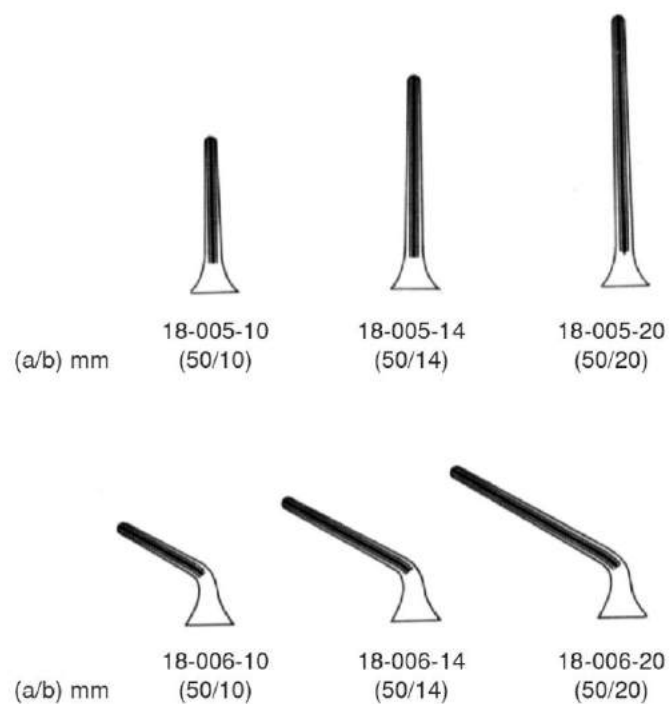

DIETHRICH

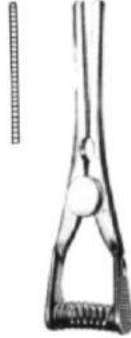
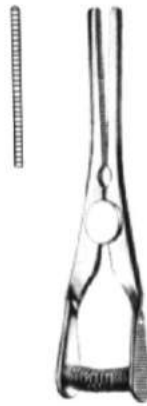

DE BAKEY-DIETHRICH

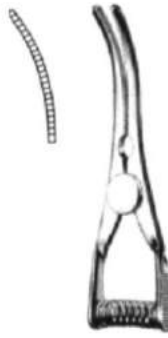
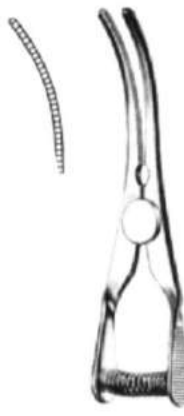
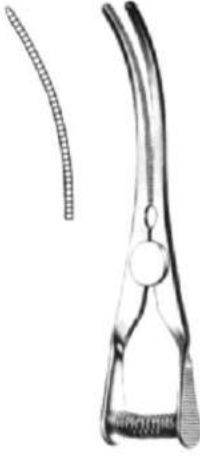

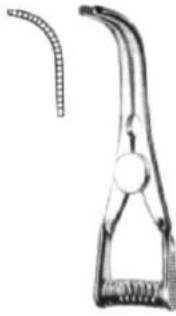
## Titanium Atraumatic Bulldog Clamps Titan Clamp Bulldog

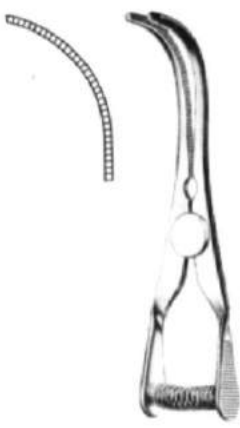
				
	3 cm, 1.2"	3.5 cm, 1.4"	4 cm, 1 1/2"	5 cm, 2"
Vein	18-010-30	18-010-35	18-010-40	18-010-50
Arterie	18-011-30	18-011-35	18-011-40	18-011-50
				
	3 cm, 1.2"	3.5 cm, 1.4"	4 cm, 1 1/2"	5 cm, 2"
Vein	18-012-30	18-012-35	18-012-40	18-012-50
Arteria	18-013-30	18-013-35	18-013-40	18-013-50
				
	3 cm, 1.2"	3.5 cm, 1.4"	4 cm, 1 1/2"	5 cm, 2"
Vein	18-014-30	18-014-35	18-014-40	18-014-50
Arterie	18-015-30	18-015-35	18-015-40	18-015-50



Atraumatic Bulldog Clamps  
Clamps Atrauma Bulldog



DE BAKEY

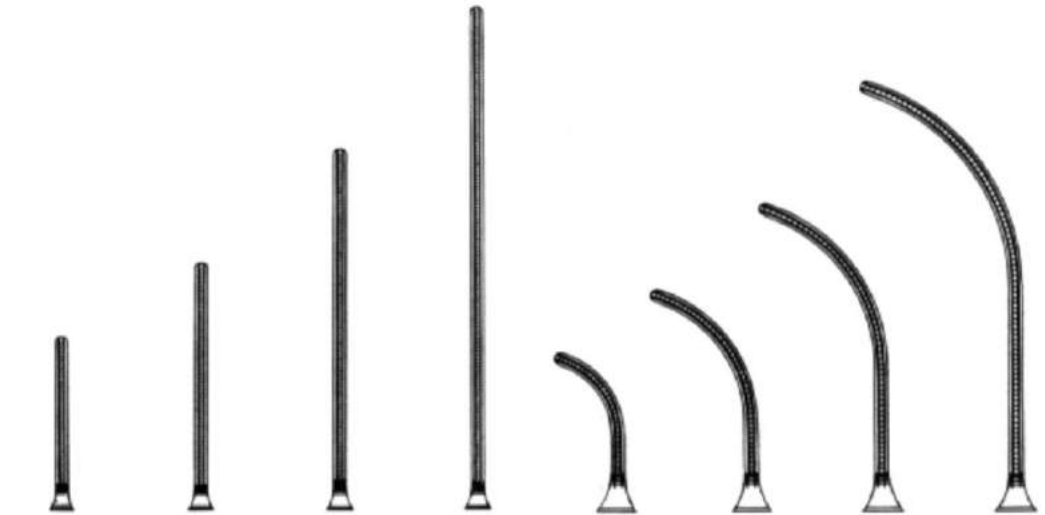

18-092-07	18-092-08	18-092-10	18-092-12	18-093-07	18-093-08	18-093-10	18-093-12
7.5 cm	8.5 cm	10.5 cm	12 cm	7 cm	8 cm	10 cm	11.5 cm
3"	3.25"	4.25"	4 3/4"	2 3/4"	3 1/8"	4"	4 1/2"

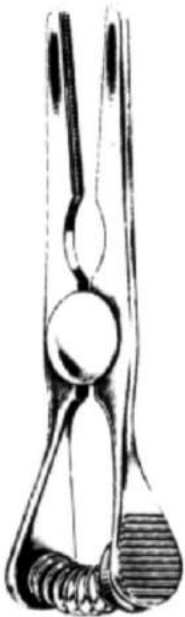

GLOVER

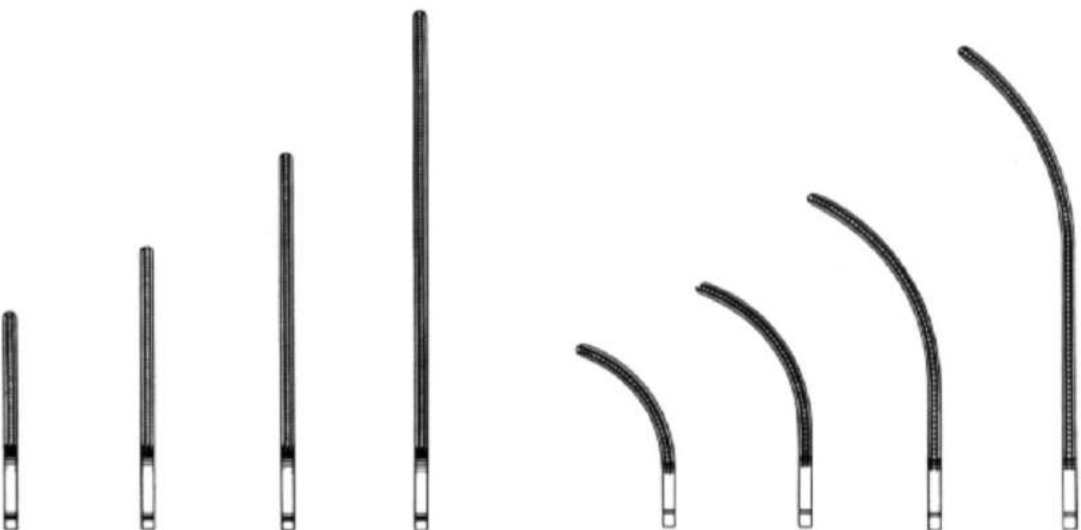

18-096-06	18-096-07	18-096-09	18-096-11	18-097-06	18-097-07	18-097-09	18-097-11
6 cm	7 cm	9 cm	11 cm	5.5 cm	6.5 cm	8.5 cm	10.5 cm
2 1/4"	2 3/4"	3 1/2"	4 3/8"	2"	2 1/2"	3 1/4"	4"

## Hemostatic Forceps Pinzas hemostáticas



**DIEFFENBACH**  
18-102-04 3.5 cm, 1.4"  
18-102-05 5.5 cm, 2.2"

Straight  
recta  
rette



Curved  
curva  
curve



**DIEFFENBACH**  
18-103-04 3.5 cm, 1.4"  
18-103-05 5.5 cm, 2.2"

### JOHNS-HOPKINS

18-110-50	5.0 cm, 2"	18-111-50
18-110-55	5.5 cm, 2.2"	18-111-55
18-110-65	6.5 cm, 2.6"	18-111-65
18-110-70	7.0 cm, 2.75"	18-111-70
18-110-75	7.5 cm, 3"	18-111-75
18-110-90	9.0 cm, 3.75"	18-111-90

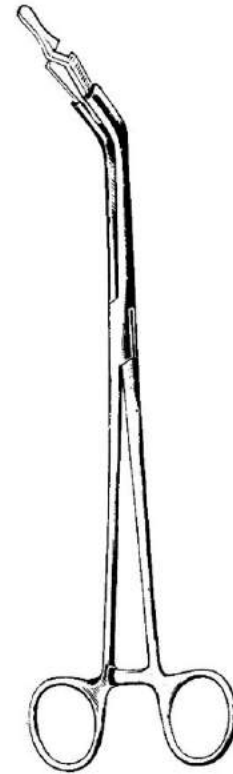

18-115-00  
23 cm, 9"

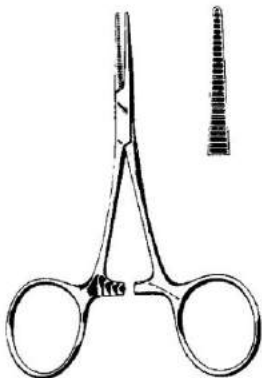

**HARTMAN**  
18-210-10  
10 cm, 4"

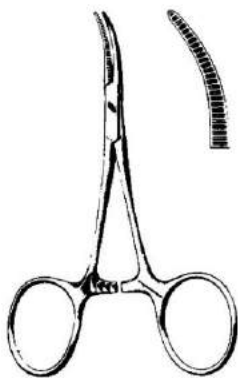

**HARTMAN**  
18-211-10  
10 cm, 4"

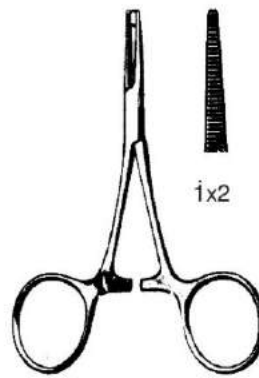

**HARTMAN**  
18-212-10  
10 cm, 4"

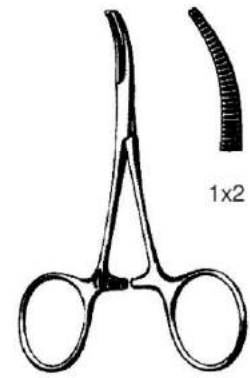

**HARTMAN**  
18-213-10  
10 cm, 4"

**HARTMAN Micro**  
18-214-10  
10 cm, 4"

**HARTMAN Micro**  
18-215-10  
10 cm, 4"





Hemostatic Forceps  
Pinzas hemostáticas

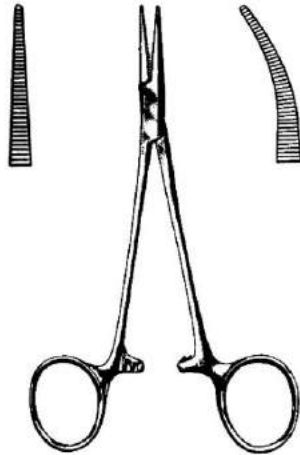

TITAN	— HALSTED Mosquito —	TITAN
18-224-12	18-220-12 12.5 cm, 5"	18-221-12 18-225-12
	18-220-14 14.0 cm, 5 1/2"	18-221-14
	18-220-18 18.0 cm, 7"	18-221-18
	18-220-21 21.0 cm, 8 1/4"	18-221-21

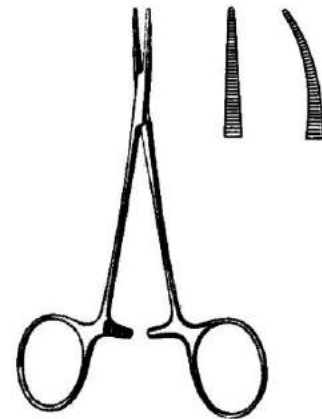

— HALSTED Mosquito X-Del —
18-222-12 12.5 cm, 5" 18-223-12
JACOBSON Micro
18-226-12 12.5 cm, 5" 18-227-12
18-226-18 18.0CM,7" 18-227-18

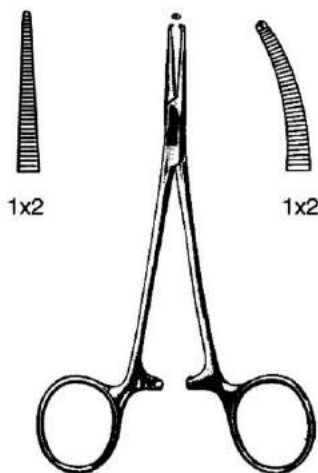

— HALSTED Mosquito —
18-230-12 12.5 cm, 5" 18-231-12
18-230-14 14.0 cm, 5 1/2" 18-231-14
18-230-18 18.0 cm, 7" 18-231-18
18-230-21 21.0 cm, 8 1/4" 18-231-21

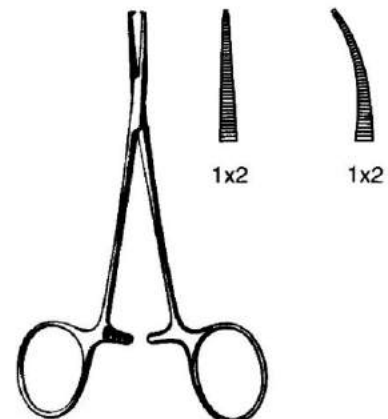

— HALSTED Mosquito X-Del —
18-232-12 12.5 cm, 5" 18-233-12



Hemostatic Forceps  
Pinzas hemostáticas

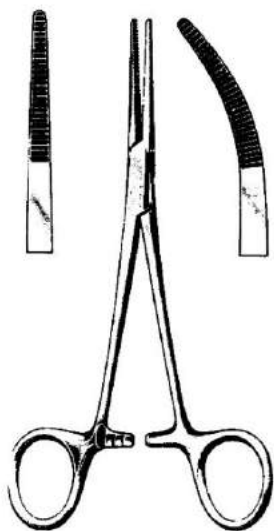

KELLY

- |           |               |           |
|-----------|---------------|-----------|
| 18-240-14 | 14 cm, 5 1/2" | 18-241-14 |
| 18-240-18 | 18 cm, 7"     | 18-241-18 |
| 18-244-14 | 14 cm, 5 1/2" | 18-245-14 |
| TITAN     |               | TITAN     |

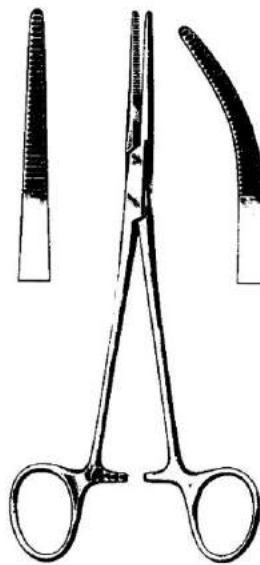

KELLY-RANKIN

- |           |               |           |
|-----------|---------------|-----------|
| 18-242-16 | 16 cm, 6 1/4" | 18-243-16 |
|-----------|---------------|-----------|

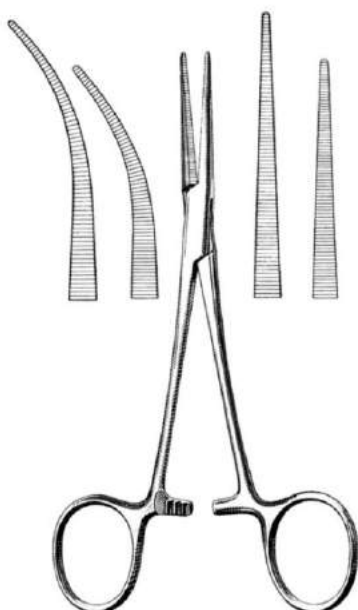

CRILE Delicate

- |           |                        |
|-----------|------------------------|
| 18-256-14 | 14 cm, 5 1/2" Straight |
| 18-256-16 | 16 cm, 6 1/4" Straight |
| 18-257-14 | 14 cm, 5 1/2" Curved   |
| 18-257-16 | 16 cm, 6 1/4" Curved   |

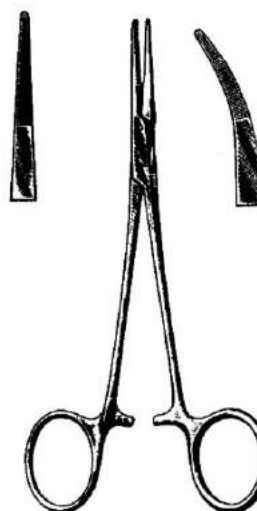

PROVIDENCE-HOSPITAL

- |           |               |           |
|-----------|---------------|-----------|
| 18-270-14 | 14 cm, 5 1/2" | 18-271-14 |
|-----------|---------------|-----------|



## Hemostatic Forceps Pinzas hemostáticas

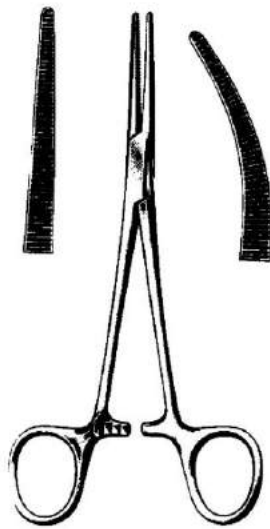

CRILE

18-250-14	14 cm, 5 1/2"	18-251-14
18-250-18	18 cm, 7"	18-251-18
18-254-14	14 cm, 5 1/2"	18-255-14
TITAN		TITAN

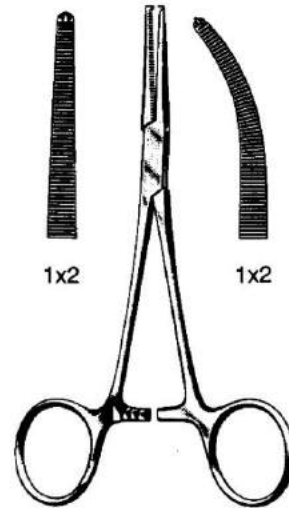

CRILE

18-260-14	14 cm, 5 1/2"	18-261-14
-----------	---------------	-----------

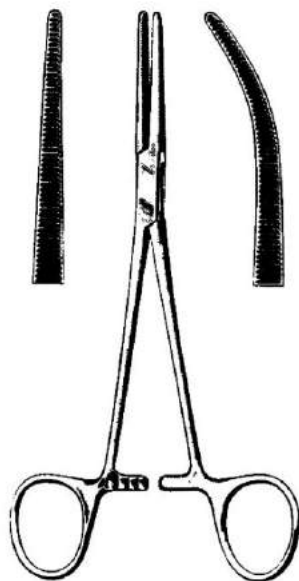

CRILE-RANKIN

18-262-16	16 cm, 6 1/4"	18-263-16
-----------	---------------	-----------

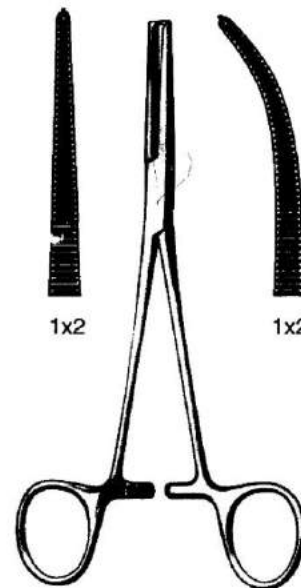

CRILE-RANKIN

18-264-16	16 cm, 6 1/4"	18-265-16
-----------	---------------	-----------



## Hemostatic Forceps Pinzas hemostáticas

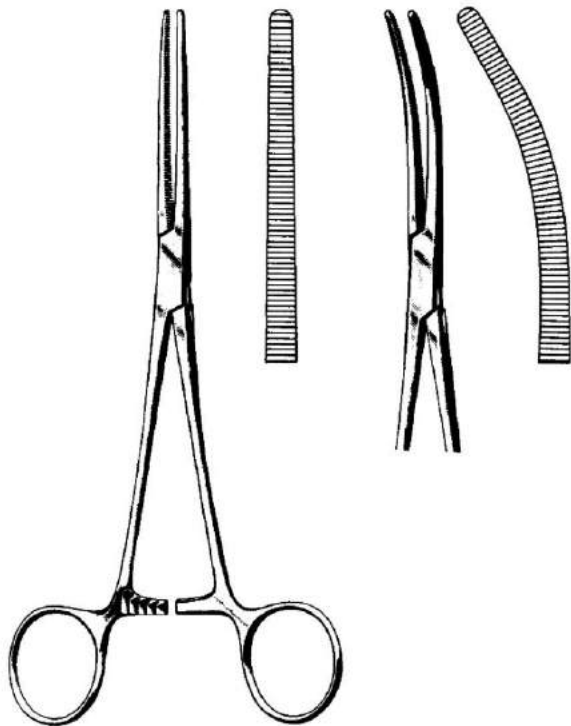

ROCHESTER-PEAN

18-310-13	13 cm, 5 1/8"	18-311-13
18-310-14	14 cm, 5 1/2"	18-311-14
18-310-16	16 cm, 6 1/4"	18-311-16
18-310-18	18 cm, 7"	18-311-18
18-310-20	20 cm, 8"	18-311-20
18-310-22	22 cm, 8 3/4"	18-311-22
18-310-24	24 cm, 9 1/2"	18-311-24
18-310-26	26 cm, 10 1/4"	18-311-26
18-310-30	30 cm, 11 3/4"	18-311-30

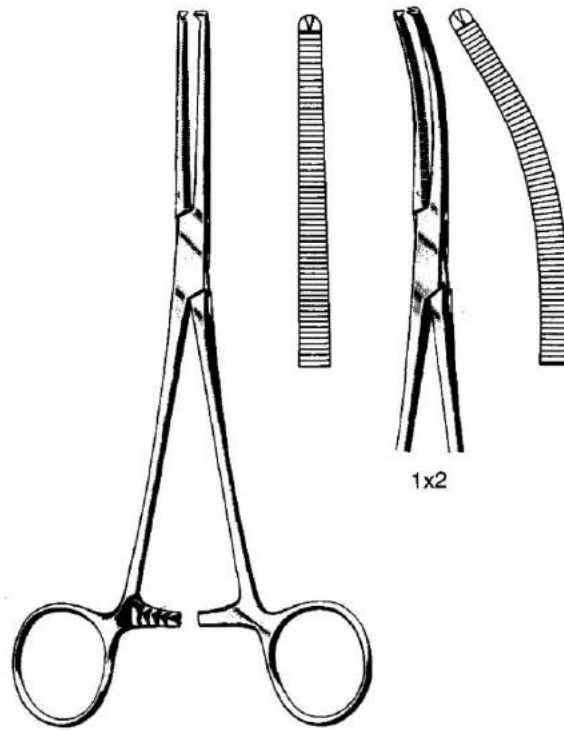

ROCHESTER-OGHSNER

18-320-13	13 cm, 5 1/8"	18-321-13
18-320-14	14 cm, 5 1/2"	18-321-14
18-320-16	16 cm, 6 1/4"	18-321-16
18-320-18	18 cm, 7"	18-321-18
18-320-20	20 cm, 8"	18-321-20
18-320-22	22 cm, 8 3/4"	18-321-22
18-320-24	24 cm, 9 1/2"	18-321-24
18-320-26	26 cm, 10 1/4"	18-321-26
18-320-30	30 cm, 11 3/4"	18-321-30

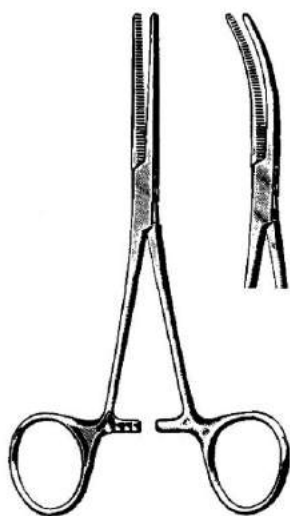

Delicate  
Delicada  
Fina

PEAN

18-312-14	14 cm, 5 1/2"	18-313-14
18-312-16	16 cm, 6 1/4"	18-313-16

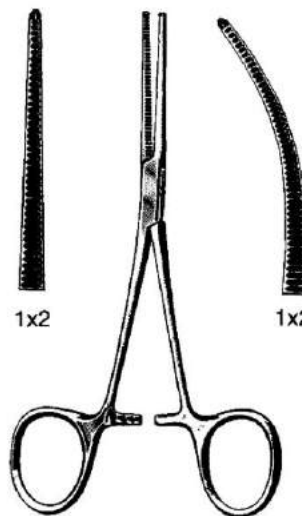

Delicate  
Delicada  
Fina

KOCHER

18-322-14	14 cm, 5 1/2"	18-323-14
18-322-16	16 cm, 6 1/4"	18-323-16



Hemostatic Forceps  
Pinzas hemostáticas

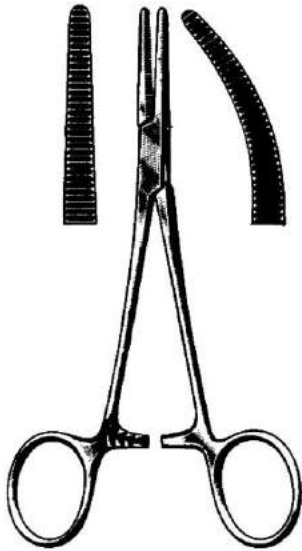

**SPENCER-WELLS**

18-330-13	13 cm, 5"	18-331-13
18-330-15	15 cm, 6"	18-331-15
18-330-18	18 cm, 7"	18-331-18
18-330-20	20 cm, 8"	18-331-20

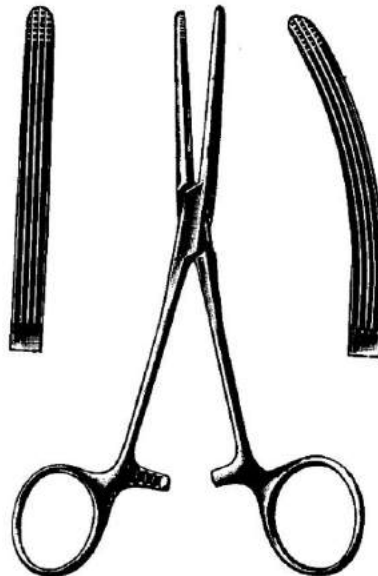

**ROCHESTER-CARMALT**

18-340-16	16 cm, 6 1/4"	18-341-16
18-340-20	20 cm, 8"	18-341-20

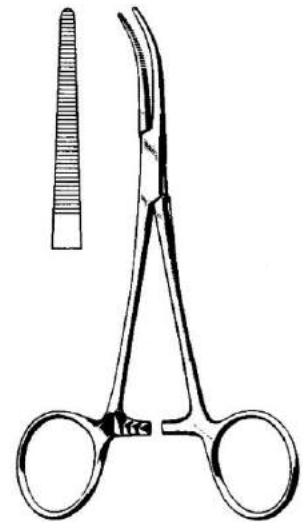

**DANDY**

18-345-12	12 cm, 4 3/4"
18-345-14	14 cm, 5 1/2"

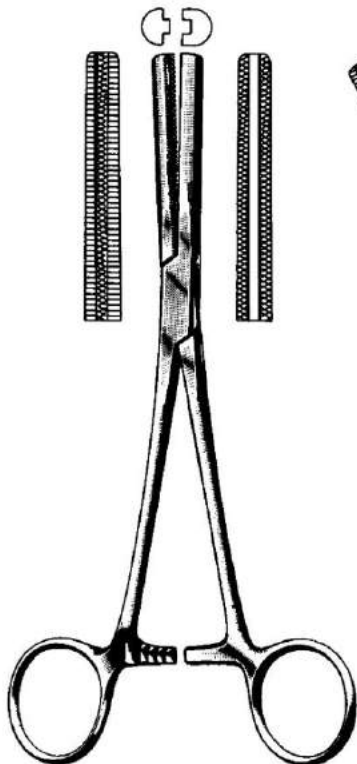

**FERGUSSON**

18-350-16	16 cm, 6 1/4"	18-351-16
18-350-20	20 cm, 8"	18-351-20

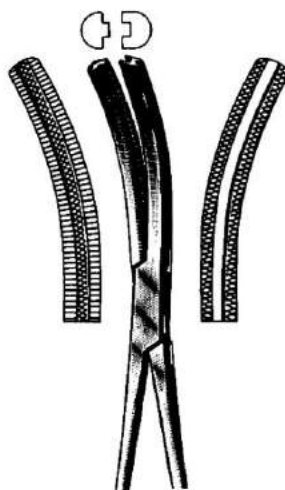

**LOVELACE**

18-356-15	15.5 cm, 6"
-----------	-------------

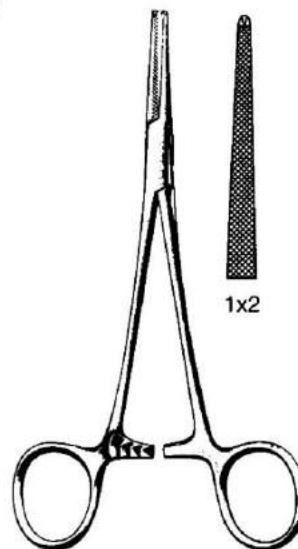

**PENNINGTON**

18-358-15	15.5 cm, 6"
18-358-20	20.0 cm, 8"

Hemostatic and Tissue Forceps  
Pinzas hemostáticas

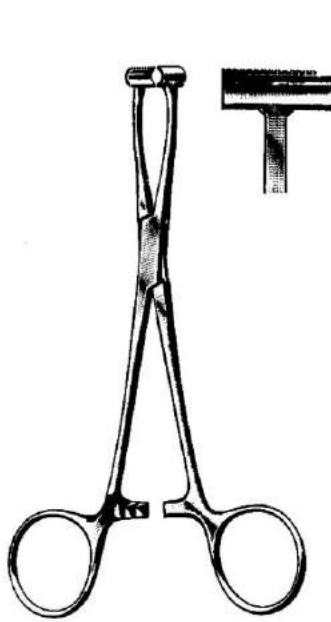

PRATT  
18-360-15 15 cm, 6"

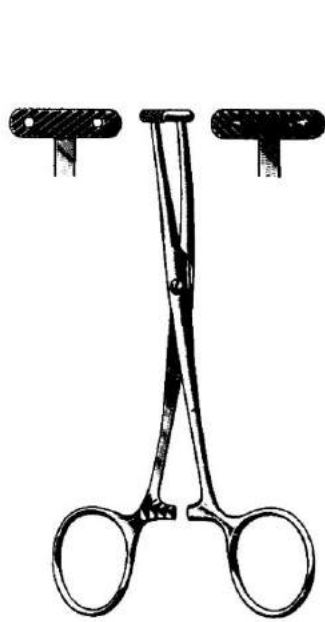

MARTEL  
18-364-14 14 cm, 5 1/2"

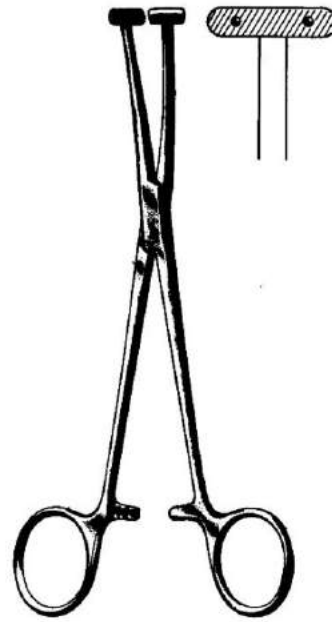

WILLET- MARTEL  
18-366-19 19 cm, 7 1/2"

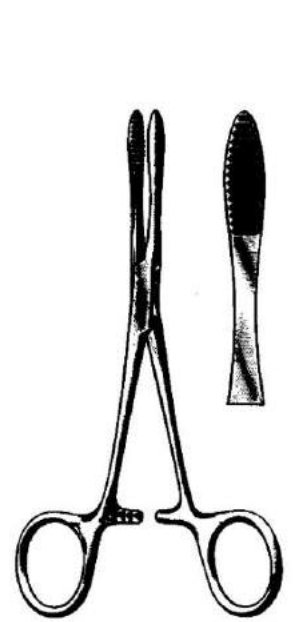

PEAN  
18-368-14 14 cm, 5 1/2"  
18-368-16 16 cm, 6 1/4"

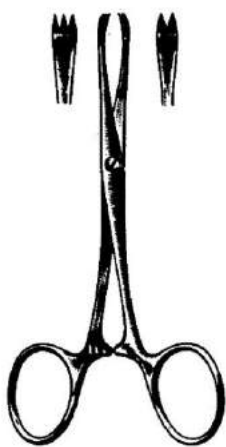

CHAPUT  
18-370-13  
13 cm, 5 1/8"

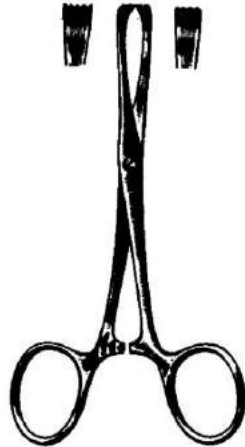

TUFFIER  
18-372-13  
13 cm, 5 1/8"



COLLIN  
18-374-14  
14 cm, 5 1/2"

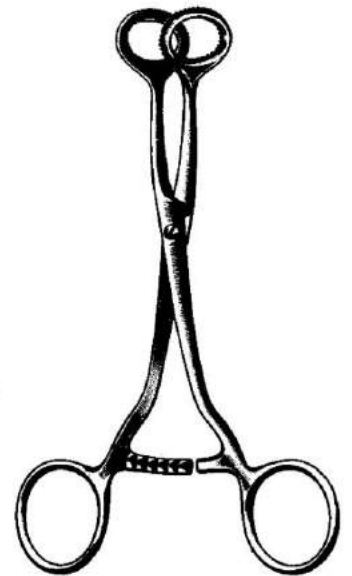

COLLIN  
18-376-16  
16 cm, 6 1/4"



Hemostatic Forceps  
Pinzas hemostáticas

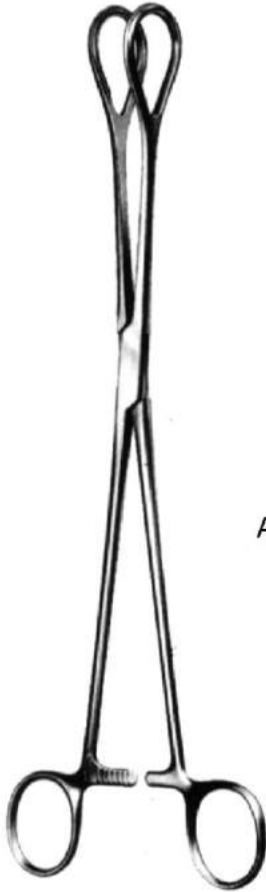

Atraumatic

FORESTER  
18-377-25 18-377-26



18-377-25  
25 cm, 10"



18-377-26  
26 cm, 10 1/4"

COLLER Curved Forceps  
5.5"  
18-347-14

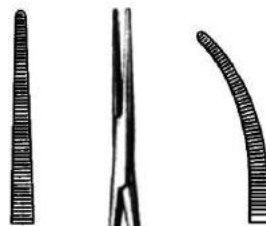

LERICHE  
18-380-15 15 cm, 6" 18-381-15

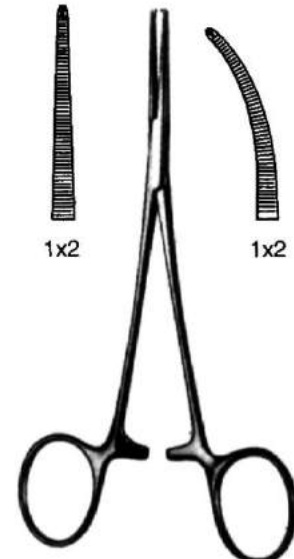

LERICHE  
18-382-15 15 cm, 6" 18-383-15

Hemostatic Forceps  
Pinzas hemostáticas

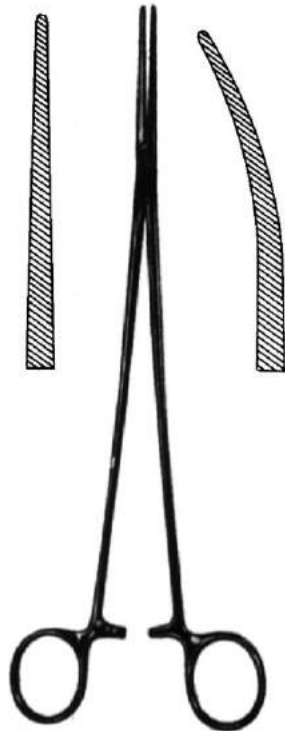

BENGOLEA

18-384-20 20 cm, 8" 18-385-20  
18-384-26 26 cm, 10 1/4" 18-385-26

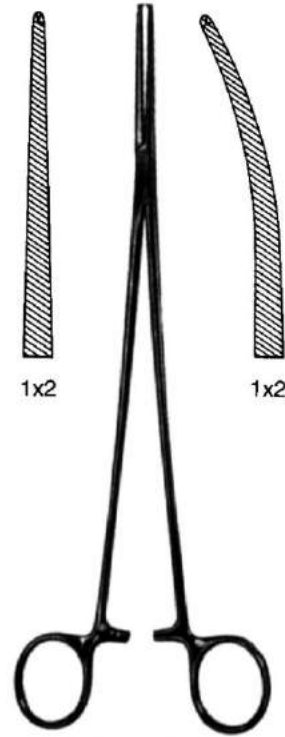

BENGOLEA

18-386-20 20 cm, 8" 18-387-20  
18-386-26 26 cm, 10 1/4" 18-387-26

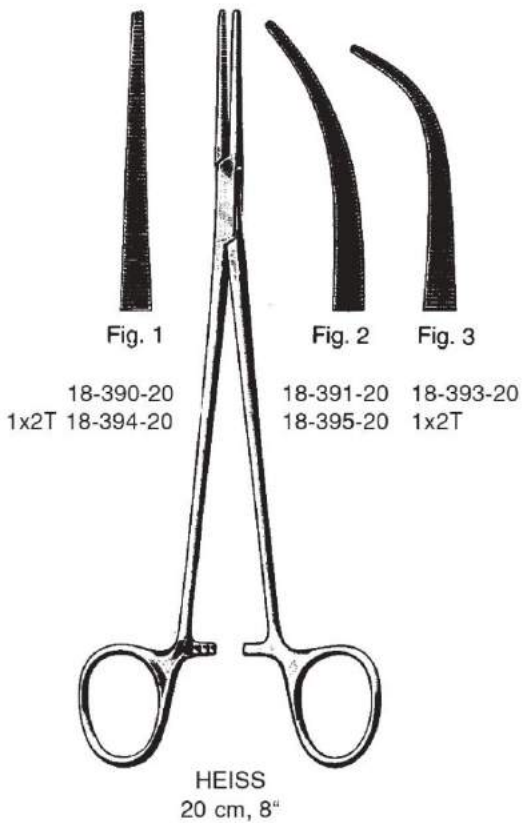





Hemostatic Forceps  
Pinzas hemostáticas

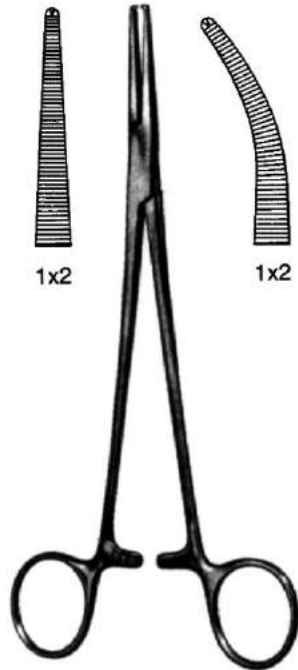

**ADSON**  
18-412-18 18.5 cm, 7 1/4" 18-413-18



**ADSON Delicate**  
18-414-20 19 cm, 7 1/2"

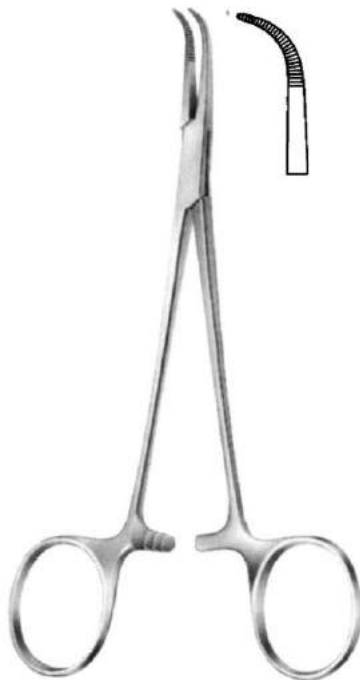

**BABY-ADSON**  
18-415-14 14.0 cm, 5 1/2"  
18-415-18 18.5 cm, 7 1/4"



**NISSEN**  
18-416-18 18.5 cm, 7 1/4"



Hemostatic Forceps  
Pinzas hemostáticas



**BABY-OVERHOLT**  
18-420-14  
14 cm, 5 1/2"

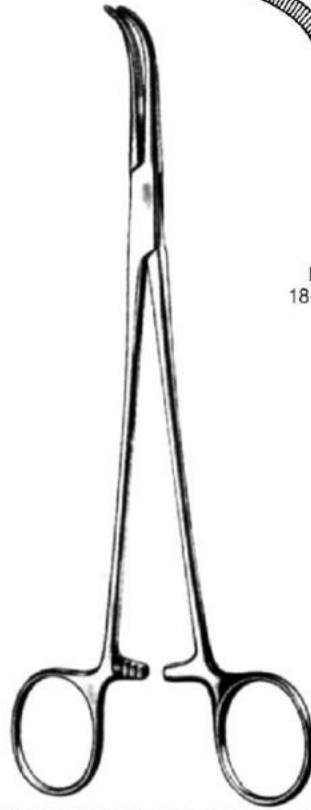

**OVERHOLT-GEISSENDOERFER**  
21 cm, 8 1/4"  
18-421-01 to 18-421-07



Fig. 1  
18-421-01



Fig. 2  
18-421-02  
18-425-02  
26 cm  
10 1/4"

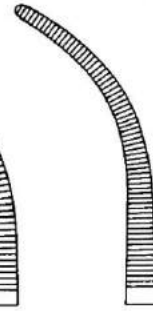

Fig. 3  
18-421-03  
18-425-03  
27 cm  
10 1/2"

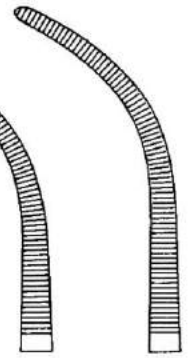

Fig. 4  
18-421-04  
18-425-04  
28 cm  
11"

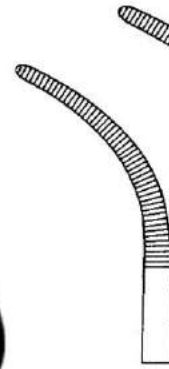

Fig. 5  
18-421-05  
18-425-05  
27 cm  
10 1/2"

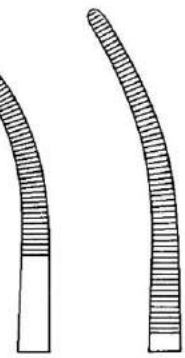

Fig. 6  
18-421-06  
18-425-06  
28 cm  
11"



Fig. 7  
18-421-07



**OVERHOLT**



18-422-00  
21.5 cm  
8 1/2"



18-422-01  
21 cm  
8 1/4"



18-422-02  
22 cm  
8 3/4"



18-422-03  
23 cm  
9"



18-422-06  
22 cm  
8.75"



Hemostatic Forceps  
Pinzas hemostáticas

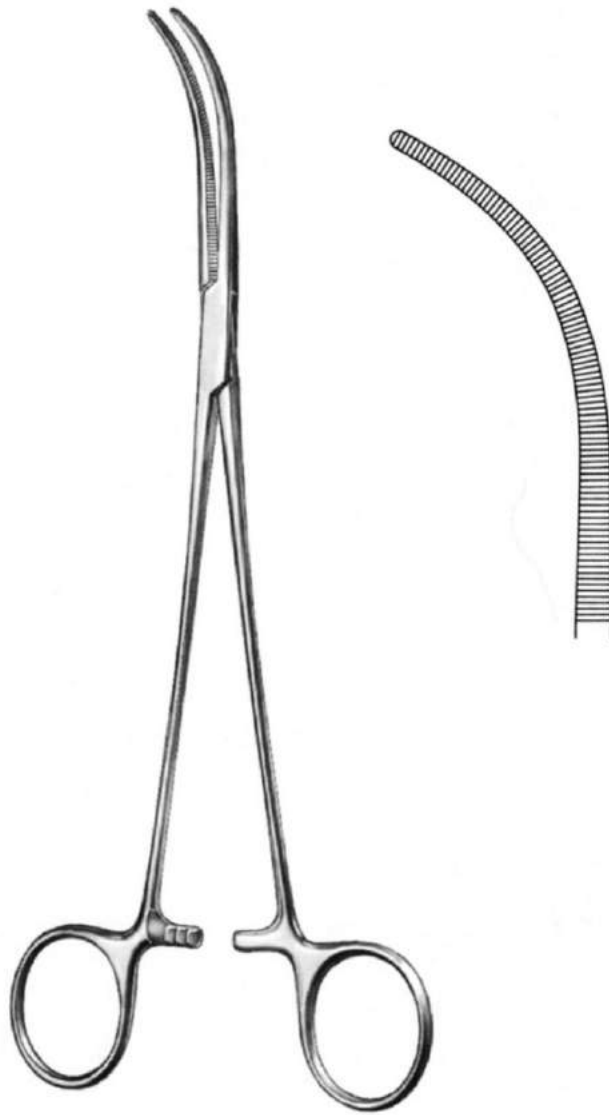

OVERHOLT-MIXTER  
18-428-21  
21.5 cm, 8 1/2"



GEMINI



18-431-13  
13 cm  
5 1/8"



18-431-16  
16 cm  
6 1/4"



18-431-18  
18 cm  
7"

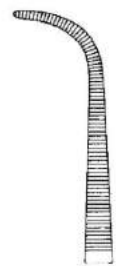

18-431-20  
20 cm  
8"

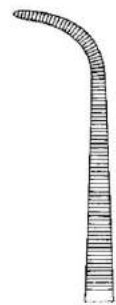

18-431-23  
23 cm  
9"

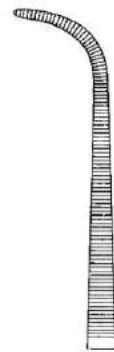

18-431-25  
25 cm  
10"

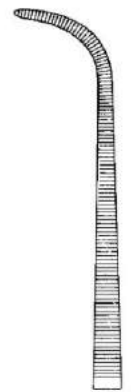

18-431-28  
28 cm  
11"



Hemostatic Forceps  
Pinzas hemostáticas



BIRKETT

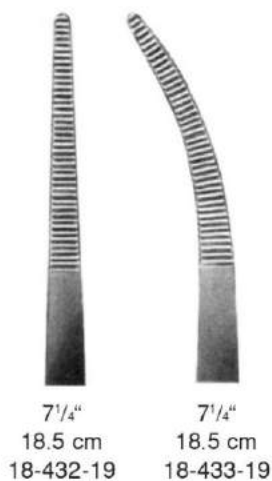

MIXTER

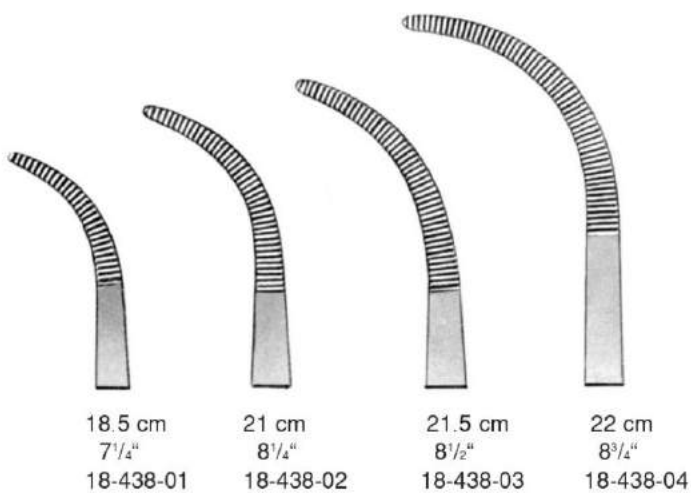



Hemostatic Forceps  
Pinzas hemostáticas

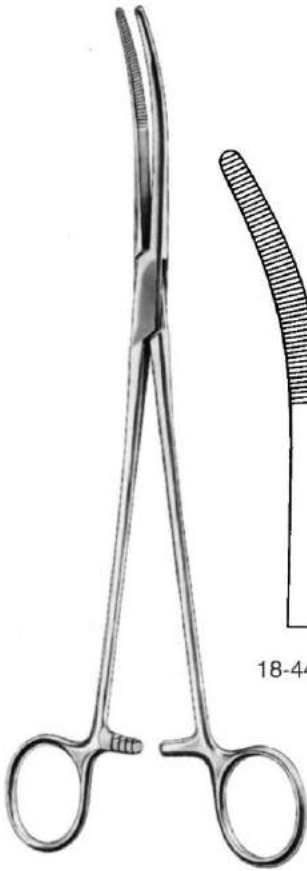

RUMEL  
23 cm, 9"

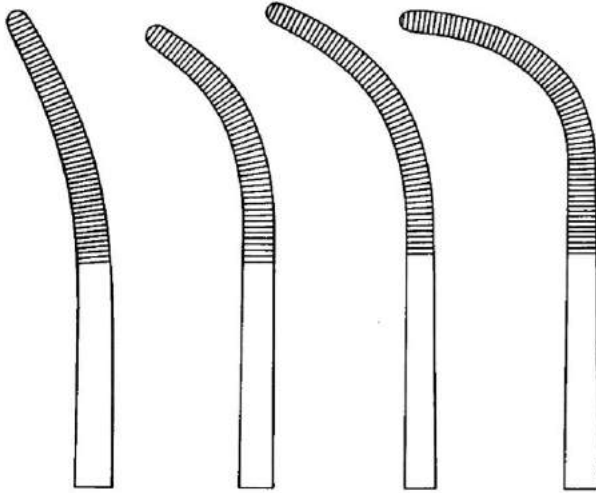

18-441-01    18-441-02    18-441-03    18-441-04



WIKSTROEM  
18-447-20  
20.5 cm, 8"

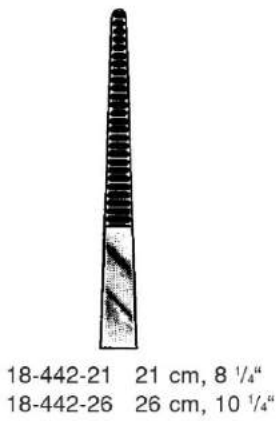

18-442-21    21 cm, 8 1/4"  
18-442-26    26 cm, 10 1/4"

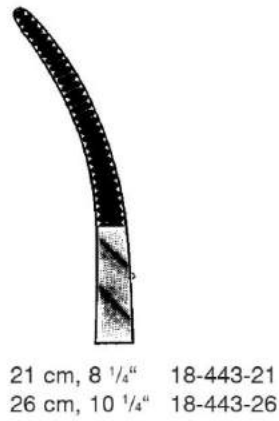

21 cm, 8 1/4"    18-443-21  
26 cm, 10 1/4"    18-443-26

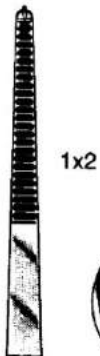

18-444-21    21 cm, 8 1/4"  
18-444-26    26 cm, 10 1/4"

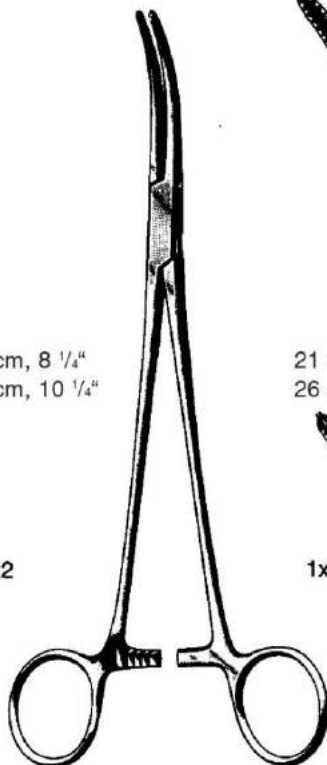

TOENNIS

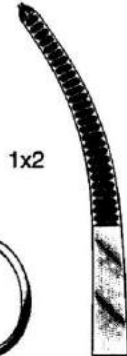

21 cm, 8 1/4"    18-445-21  
26 cm, 10 1/4"    18-445-26

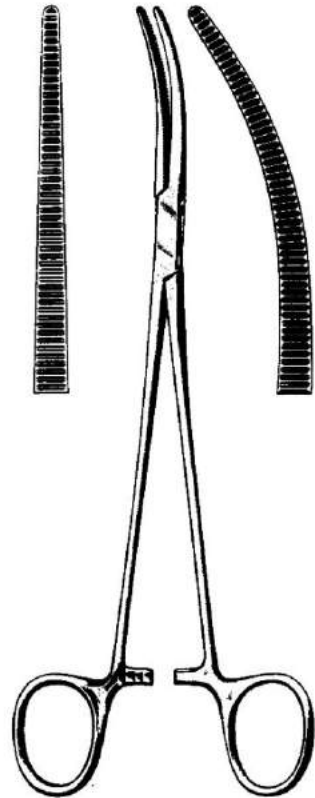

ROBERTS  
18-448-22    22 cm, 8 3/4"    18-449-22



Hemostatic Forceps  
Pinzas hemostáticas



CRAFOORD  
18-453-18 18 cm, 7"  
18-453-24 24 cm, 9 1/2"

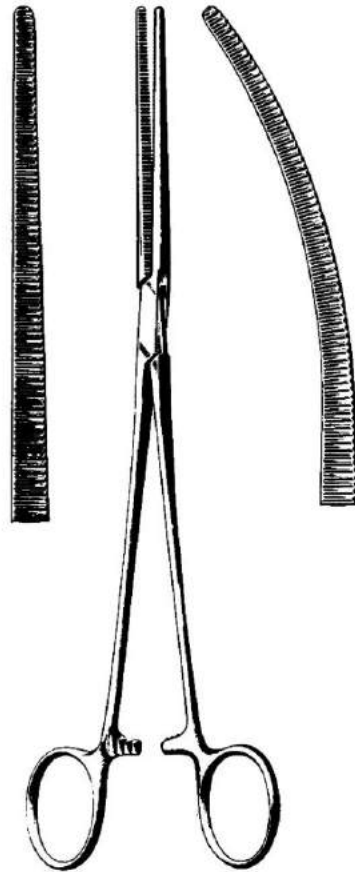

SAROT  
18-450-24 24 cm, 9 1/2" 18-451-24

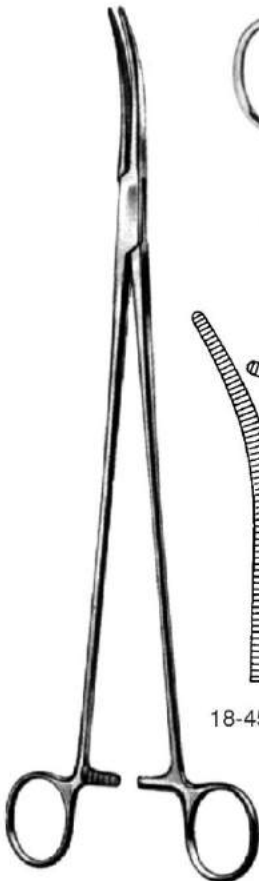

ZENKER  
29.5 cm, 11 1/2"

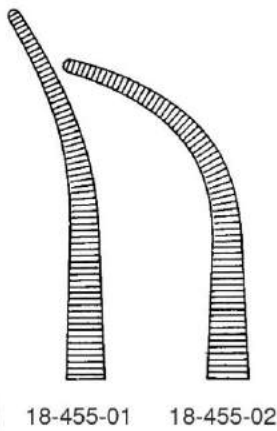

18-455-01 18-455-02

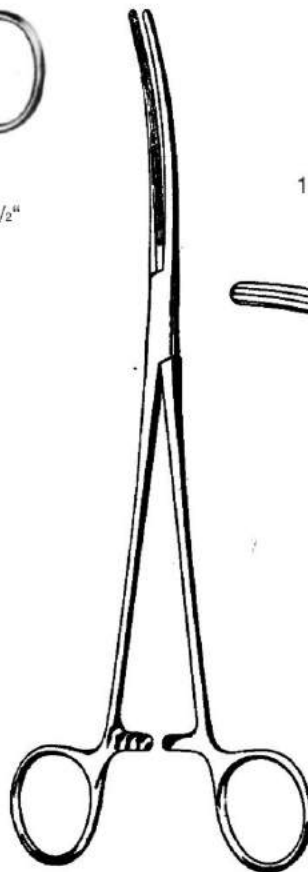

CRAFOORD-SELLORS  
24 cm, 9 1/2"

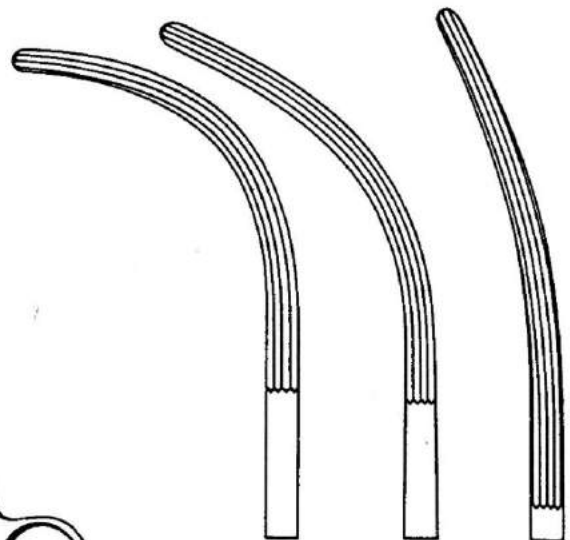

18-456-01 18-456-02 18-456-03



Hemostatic Forceps  
Pinzas hemostáticas



**LAWRENCE**  
18-457-28 28 cm, 11"



**MEEKER**  
18-459-18 18 cm, 7"  
18-459-28 28 cm, 11"

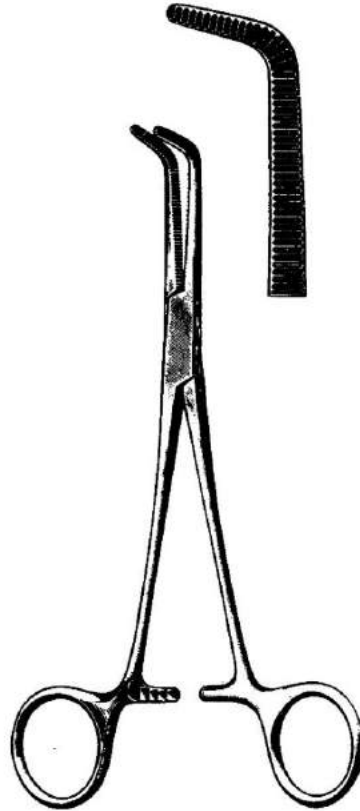

**MIXTER**  
18-471-14 14 cm, 5 1/2"  
18-471-16 16 cm, 6 1/4"  
18-471-18 18 cm, 7"  
18-471-23 23 cm, 9"

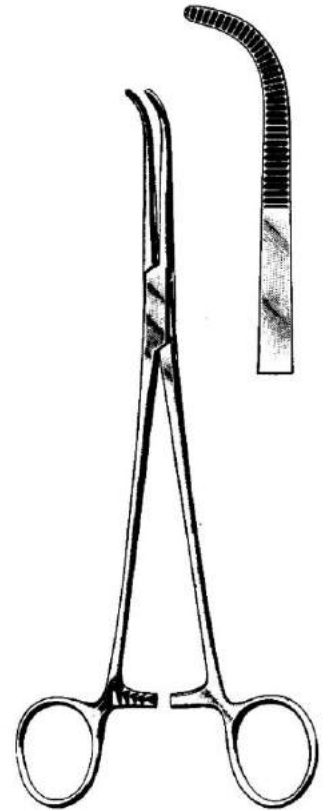

**MIXTER**  
18-473-22  
22 cm, 8 3/4"



**KANTROWITZ**  
18-474-19 19 cm, 7 1/2"  
18-474-24 24 cm, 9 1/2"  
18-474-26 26 cm, 10 1/4"

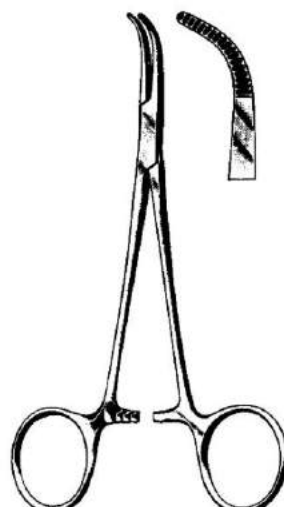

**BABY-MIXTER**  
18-475-14  
14 cm, 5 1/2"

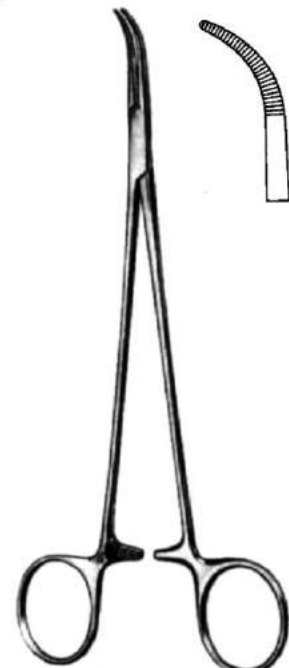

**BABY-MIXTER**  
18-475-18  
18 cm, 7"



Hemostatic Forceps  
Pinzas hemostáticas

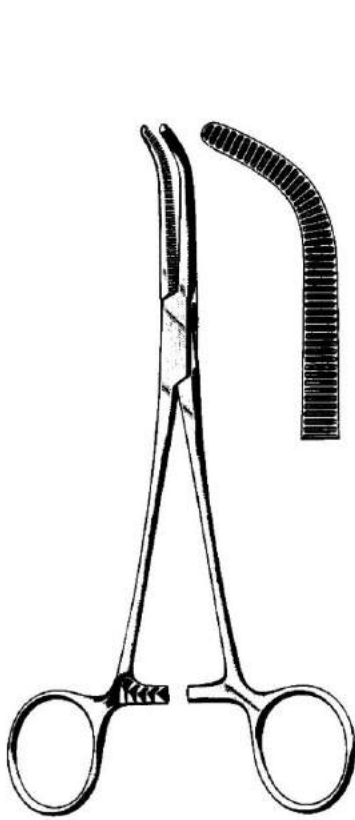

MIXTER-O'SHAUGNESSY  
18-477-15 15.5 cm, 6"  
18-477-19 19.0 cm, 7 1/2"



MIXTER

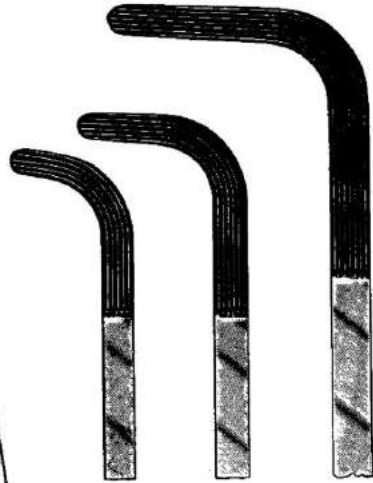

18-479-22 22 cm 8 3/4"  
18-479-25 25 cm 10"  
18-479-28 28 cm 11"

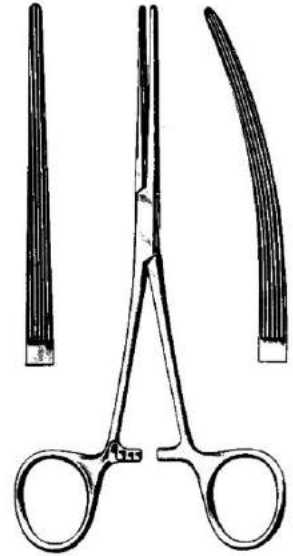

BAINBRIDGE  
18-480-15 15.0 cm, 6" 18-481-15  
18-480-18 18.5 cm, 7 1/4" 18-481-18



LAHEY  
18-491-19 19 cm, 7 1/2"

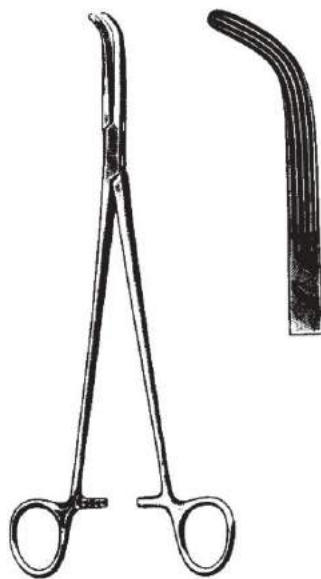

LAHEY  
18-493-23 23 cm, 9"



LOWER  
18-495-18 18 cm, 7"



JOHNS-HOPKINS  
18-497-20 20 cm, 8"





Hemostatic Forceps  
Pinzas hemostáticas

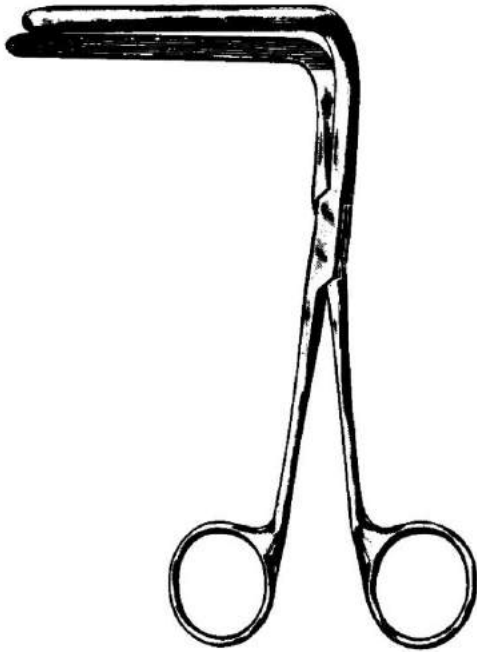

MIXTER  
18-499-16  
16.5 cm, 6 1/2"

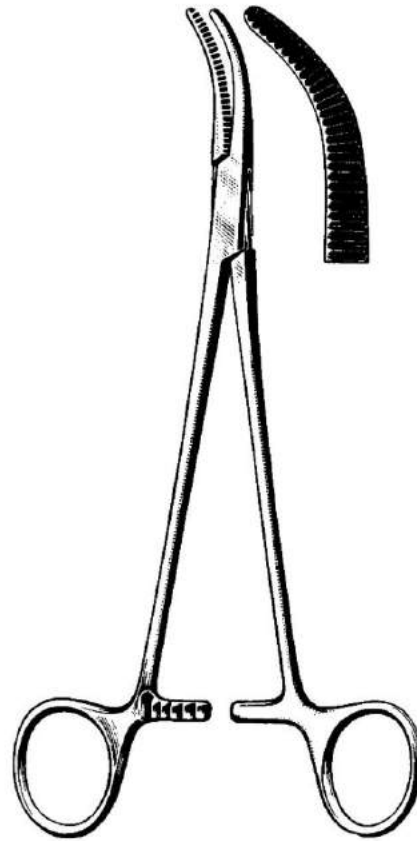

MOYNIHAN  
18-501-23  
23 cm, 9"

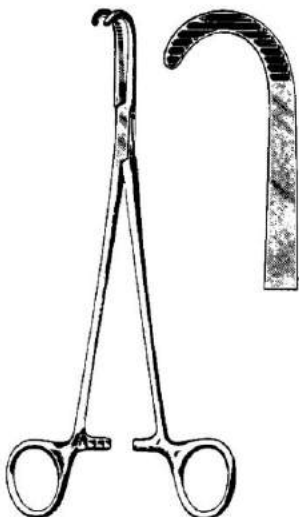

DESJARDINS  
18-503-21 21 cm, 8 1/4"

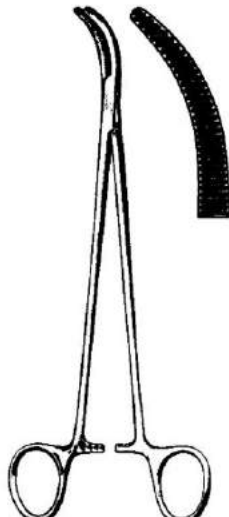

DESJARDINS  
18-505-21 21 cm, 8 1/4"

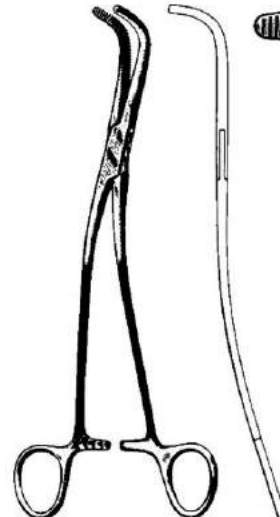

GRAY

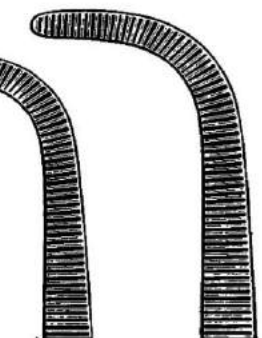

18-507-22  
22 cm  
8 3/4"

18-507-23  
23 cm  
9"



Hemostatic Forceps  
Pinzas hemostáticas

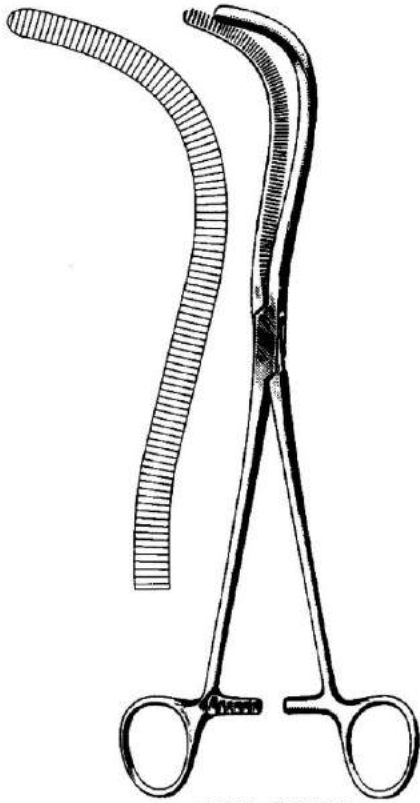

MAYO-GUYON  
18-513-23  
23 cm, 9"

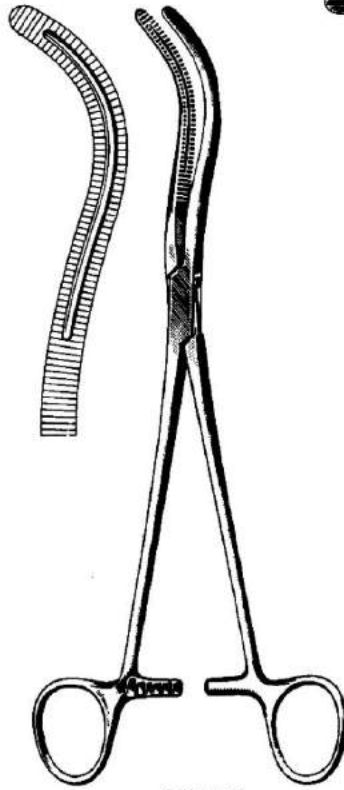

STILLE  
18-515-23  
23 cm, 9"

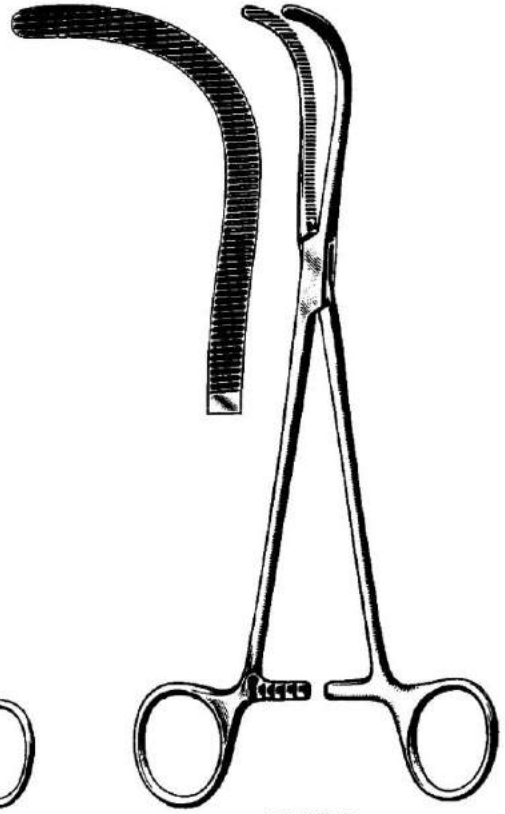

GUYON  
18-517-23  
23 cm, 9"

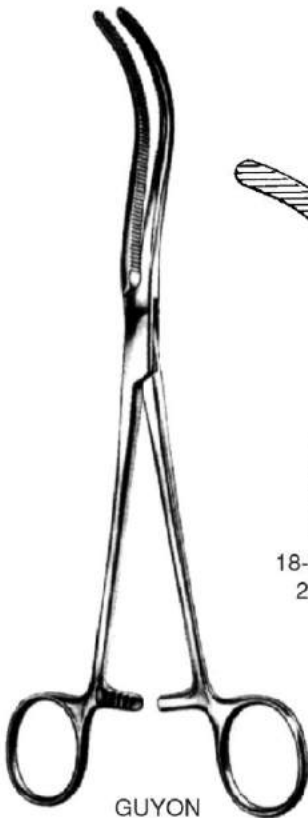

GUYON

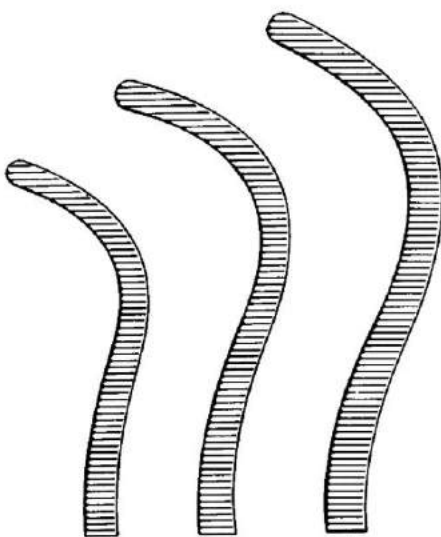

18-519-20 20 cm 8"  
18-519-22 22 cm 8 3/4"  
18-519-24 24 cm 9 1/2"



GUYON



18-520-24  
24 cm  
9 1/2"

18-520-23  
23 cm  
9"

Atraumatic



Hysterectomy Forceps  
Pinzas para histerectomía

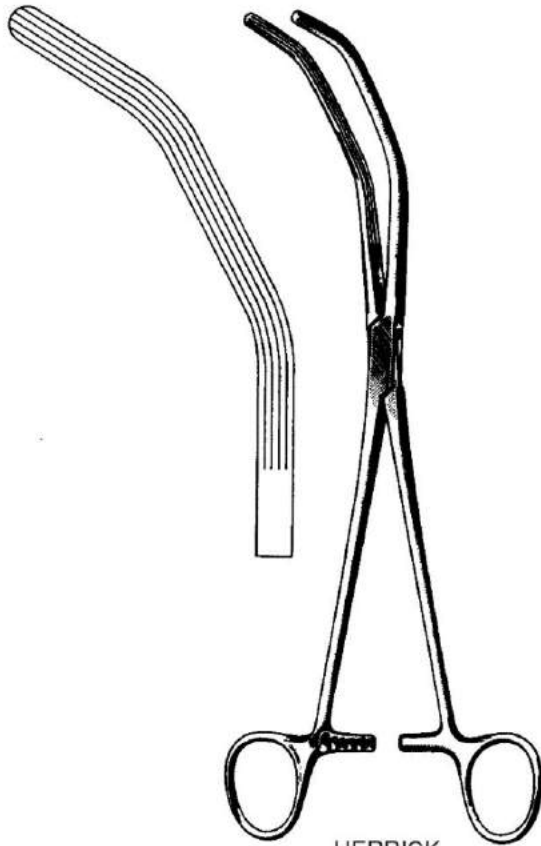

HERRICK  
18-523-23  
23 cm, 9"

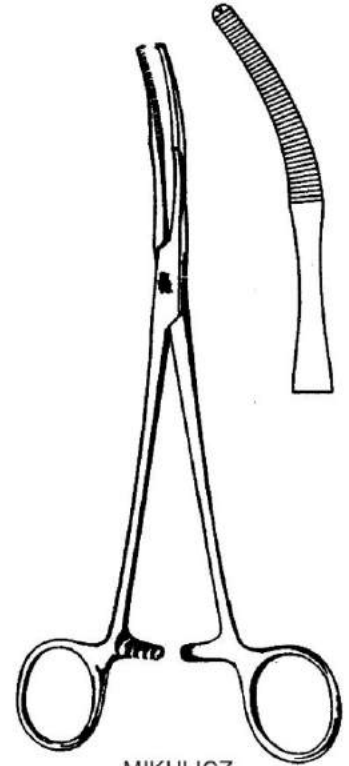

MIKULICZ  
18-551-14 14 cm, 5 1/2" BABY  
18-551-18 18 cm, 7"  
18-551-20 20 cm, 8"

Peritoneum Forceps  
Pinzas para peritoneo  
Pinze peritoneali

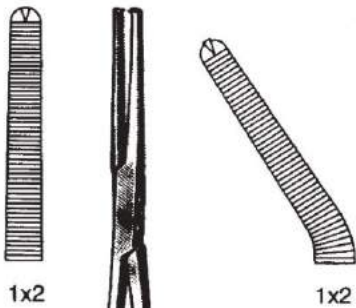

1x2

1x2

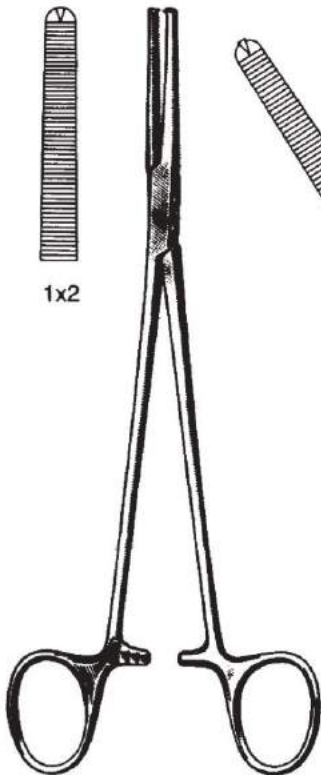

PHANEUF

18-554-21 21 cm, 8 1/4" 18-555-21



MIKULICZ

18-556-24 24 cm, 9 1/2"

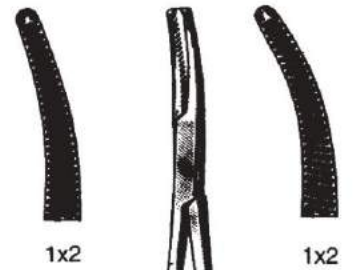

1x2

1x2

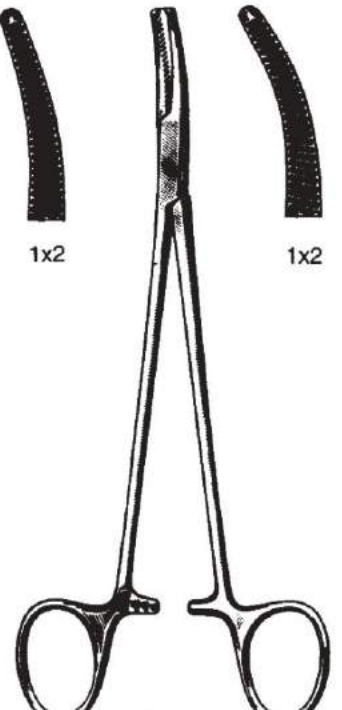

FAURE

18-561-20 20 cm, 8" 18-563-20

Hysterectomy Forceps  
Pinzas para histerectomía



WERTHEIM  
18-570-23  
23.5 cm, 9 1/4"

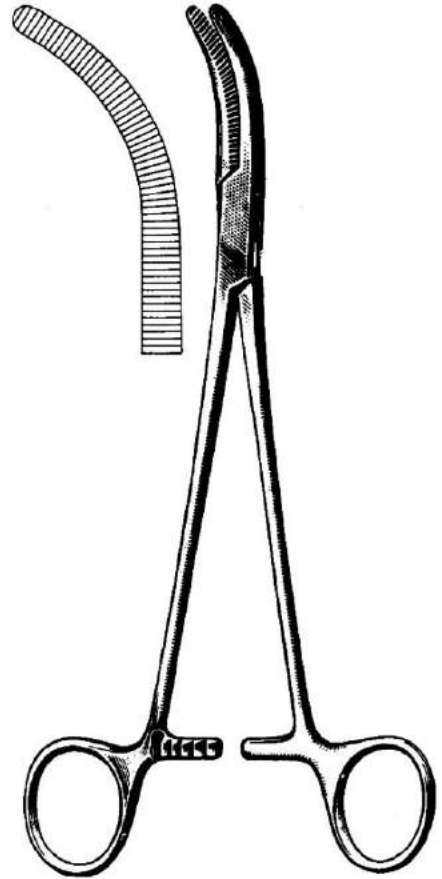

WERTHEIM  
18-571-25  
25 cm, 10"

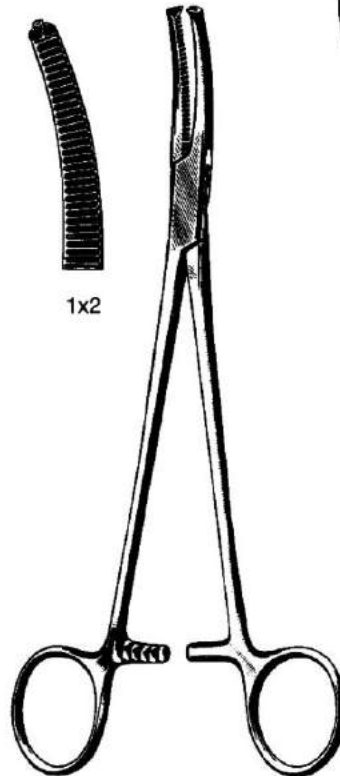

WERTHEIM  
18-573-22 22 cm, 8 3/4"



Hysterectomy Forceps  
Pinzas para histerectomía



SEGOND-LANDAU  
18-574-24  
24 cm, 9 1/2"



SEGOND  
18-575-24  
24 cm, 9 1/2"

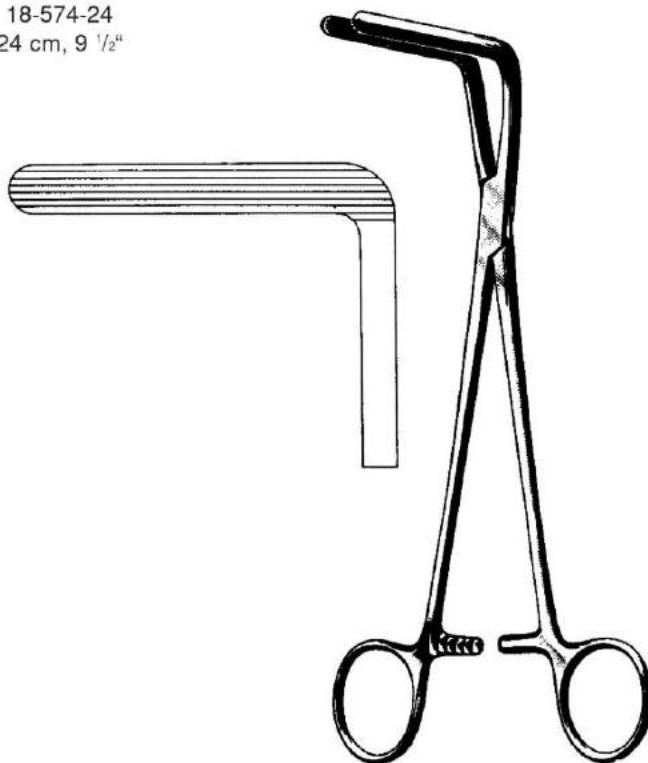

WERTHEIM-CULLEN  
18-579-21 21.5 cm, 8 1/2"

Hysterectomy Forceps  
Pinzas para histerectomía

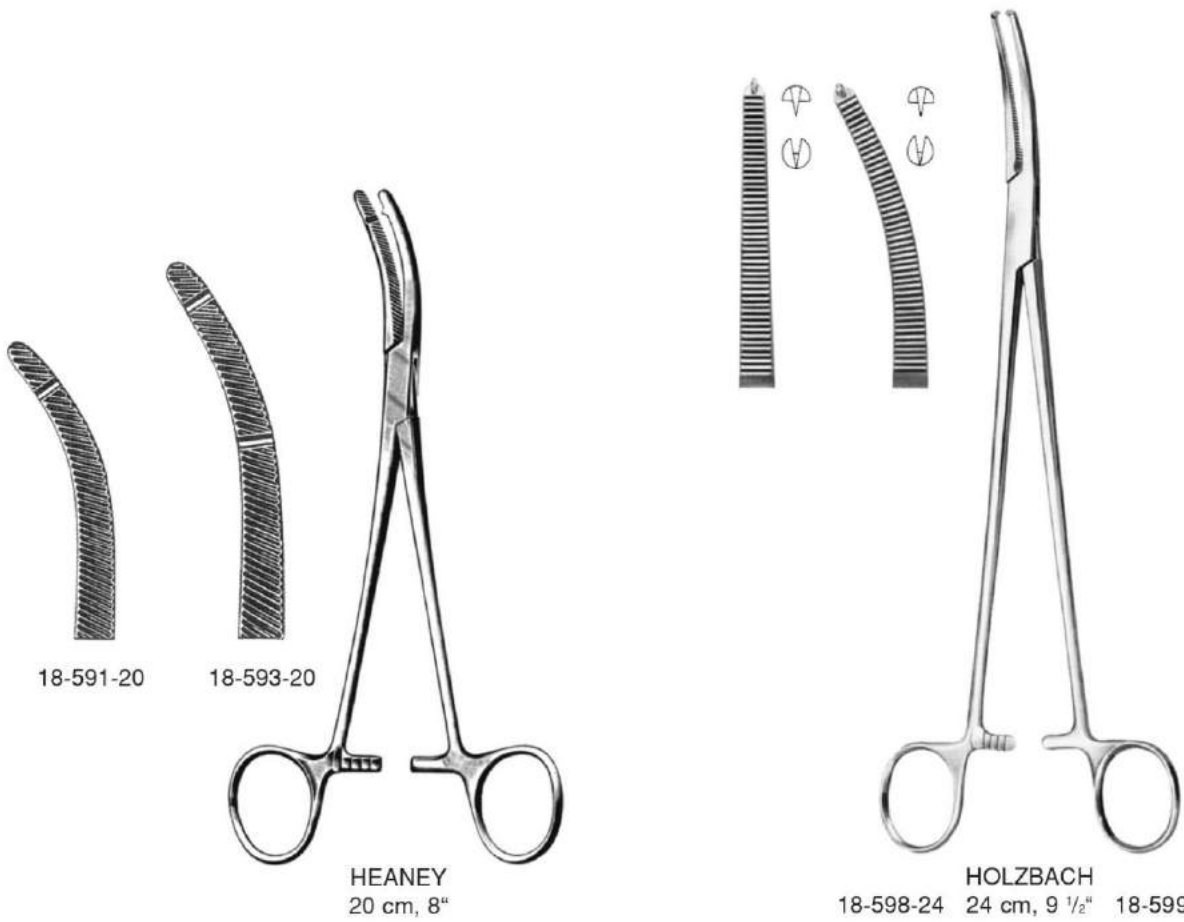
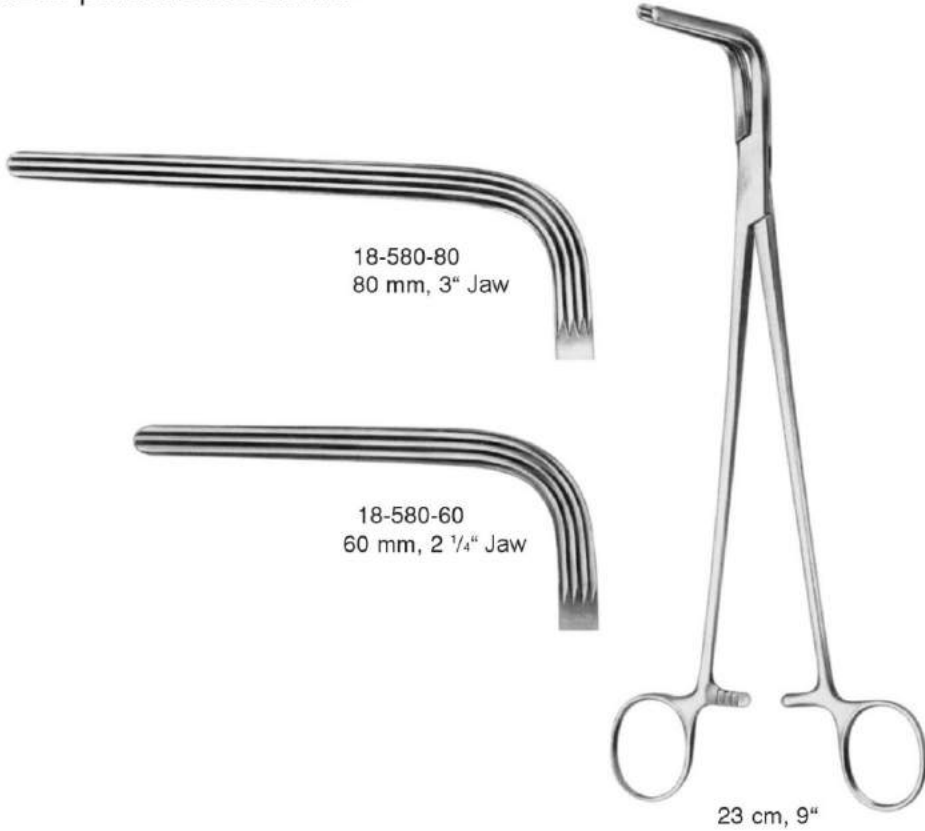



Hysterectomy Forceps  
Pinzas para histerectomía

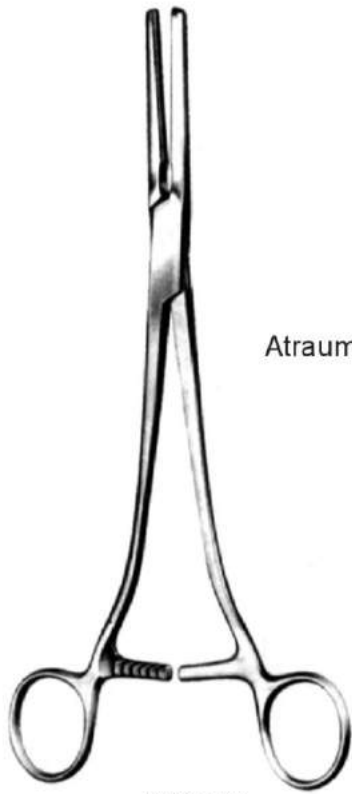

Atraumatic

ROGERS  
18-595-10 to 18-597-40

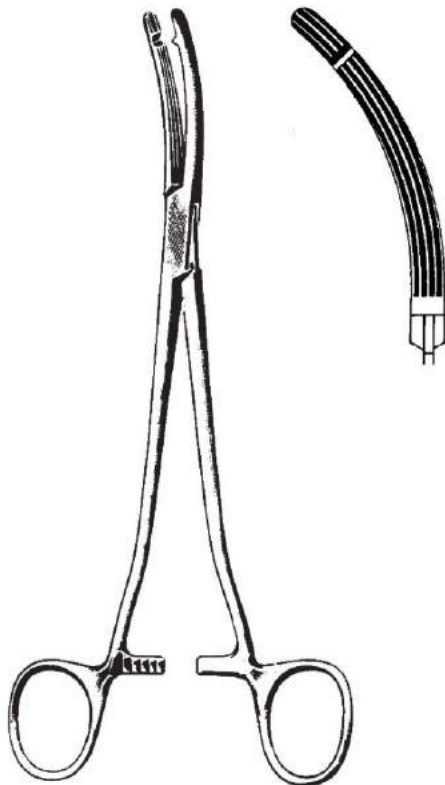
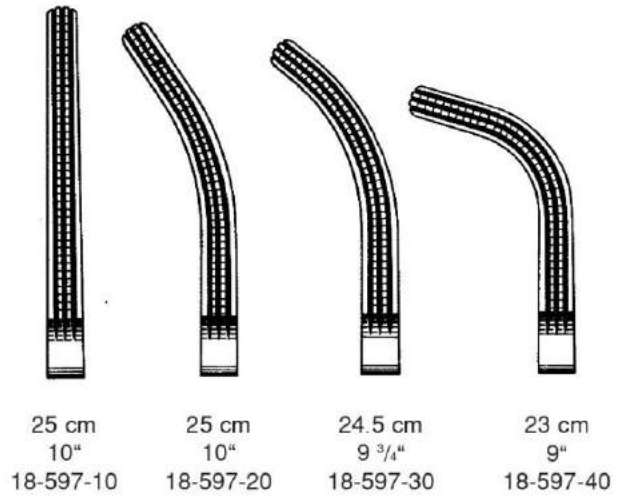
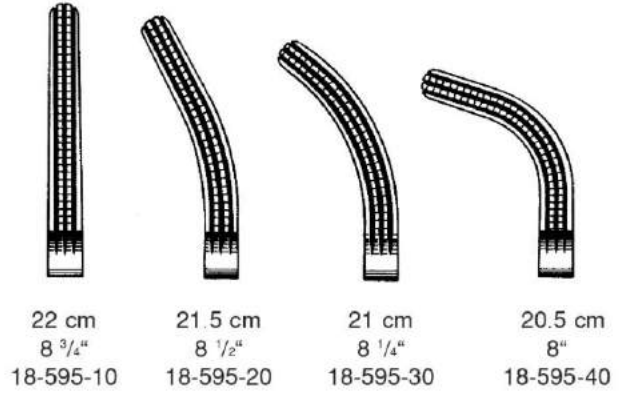

HEANY-BALLENTINE  
18-601-20  
20 cm, 8"

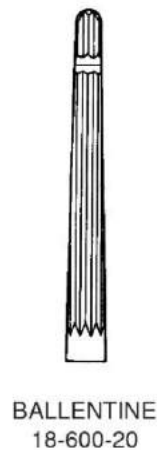

Hysterectomy Forceps  
Pinzas para histerectomía



WERTHEIM  
18-605-26  
25.5 cm, 10"





Tubing Clamps  
Pinzas cierra tubos



KLINIKUM-BERLIN  
18-702-14  
14.5 cm, 5 3/4"



VORSE



18-710-15  
15 cm, 6"



18-710-18  
18 cm, 7"



18-710-20  
20 cm, 8"

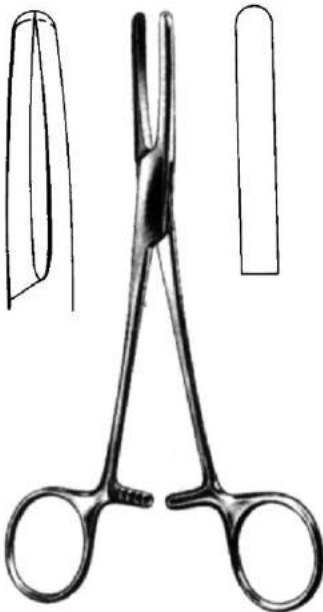

PRESBYTERIAN  
18-704-16 16 cm, 6 1/4"  
18-704-18 18 cm, 7"



US PATTERN



18-712-15  
15 cm, 6"



18-712-18  
18 cm, 7"



18-712-20  
20 cm, 8"







## Towel Clamps Pinzas de campos



**SCHAEDEL**  
20-101-09  
9 cm, 3 1/2"



**JONES**  
20-103-07  
7 cm, 2 3/4"  
20-103-09  
9 cm, 3 1/2"



**JONES-CLIP**  
20-105-09  
9 cm, 3 1/2"

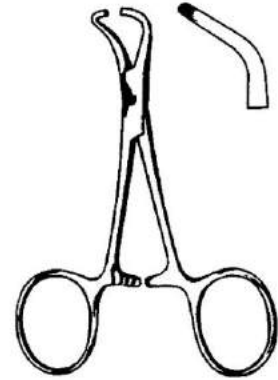

**TOHUKU**  
20-107-10 10 cm, 4"  
20-107-13 13 cm, 5 1/8"

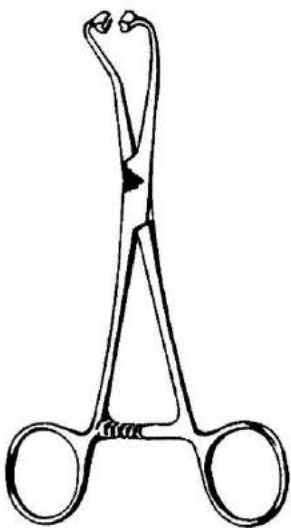

**PEERS**  
20-108-14  
14.5 cm, 5 3/4"



**BACKHAUS**  
20-111-09 9 cm, 3 1/2"  
20-111-11 11 cm, 4 3/8"  
20-111-13 13 cm, 5 1/8"  
20-111-15 15 cm, 6"



**BACKHAUS-CLIP**  
20-115-11  
11 cm, 4 3/8"

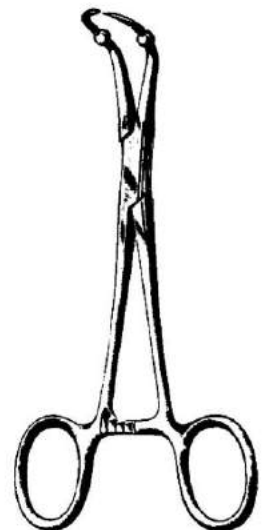

**ROEDER**  
20-117-13  
13 cm, 5 1/8"



Towel Clamps  
Pinzas de campos

HOFF	20-127-10	4"
NON-PERF	20-127-10	4"
TOWEL CLAMP	20-127-14	5"

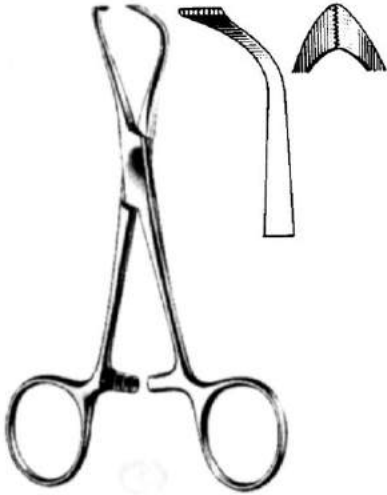

**LORNA**  
 20-121-11 11 cm, 4 3/8"  
 20-121-13 13 cm, 5 1/8"



**BALL AND SOCKET**  
 20-123-11 11 cm, 4 3/8"  
 20-123-13 13 cm, 5 1/8"



20-125-14  
 14.5 cm, 5 3/4"

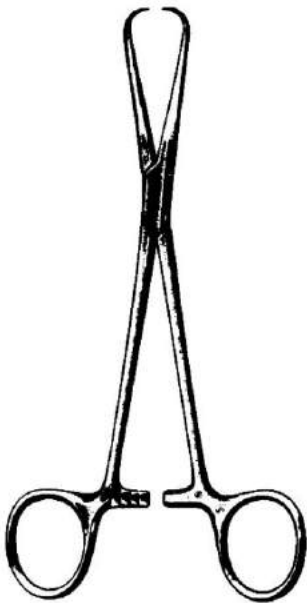

**BERNHARD**  
 20-140-16  
 16.5 cm, 6 1/2"

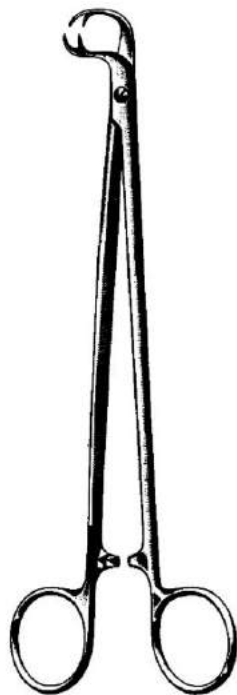

**MOYNIHAN**  
 20-150-19  
 19 cm, 7 1/2"



**DOYEN**  
 20-161-18  
 18 cm, 7"

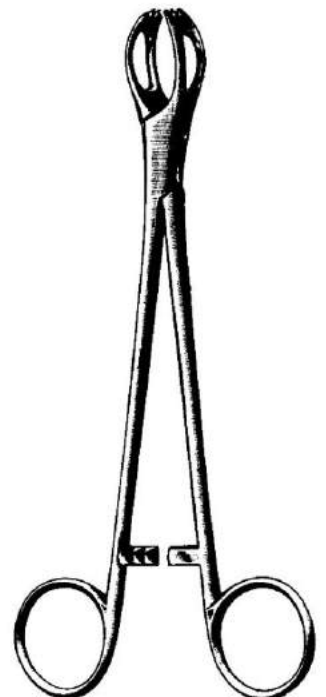

**LANE**  
 20-164-15 15 cm, 6"  
 20-164-20 20 cm, 8"



Dressing Forceps  
Pinzas porta-esponjas

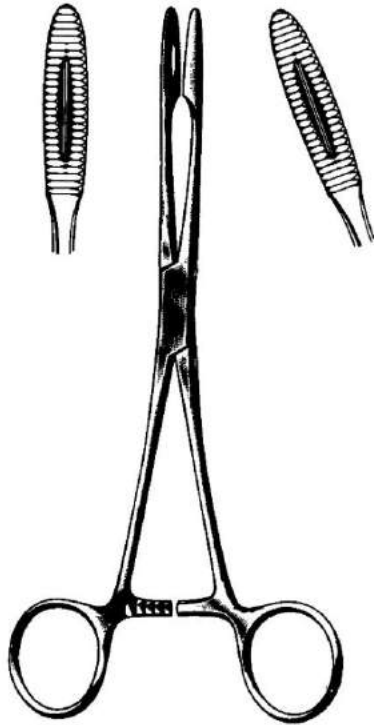

GROSS-MAIER

22-110-20 20 cm, 8" 22-111-20  
22-110-25 25 cm, 10" 22-111-25

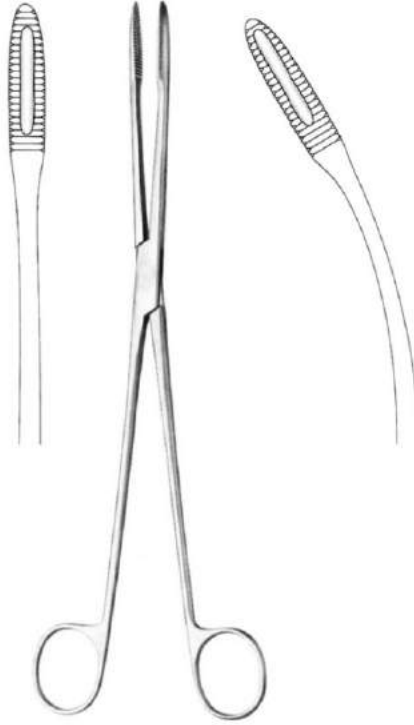

GROSS-MAIER

22-112-20 20 cm, 8" 22-113-20  
22-112-25 25 cm, 10" 22-113-25

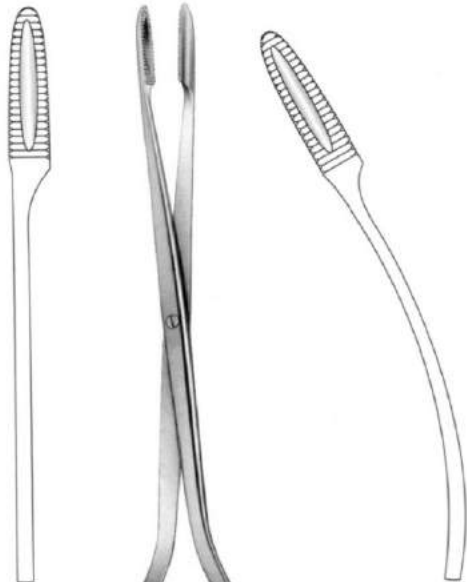

22-120-28

22-121-28

SIMS-MAIER  
28 cm, 11"



22-131-21

DUPLAY-KORNZANGE  
21 cm, 8 1/4"



Dressing Forceps  
Pinzas porta-esponjas



22-133-17

**KORNZANGE**  
17 cm, 6 3/4"

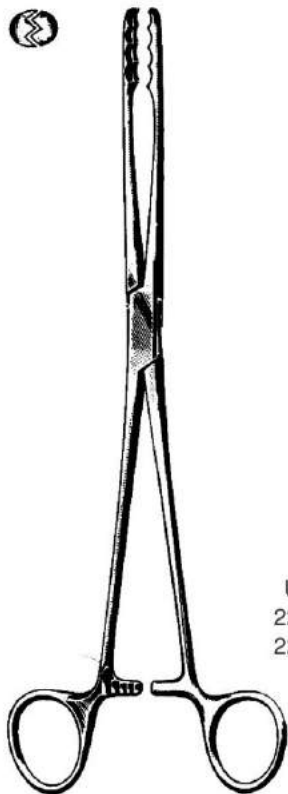

**ULRICH**  
22-160-22  
22-160-25



22 cm, 8 3/4"  
25 cm, 10"

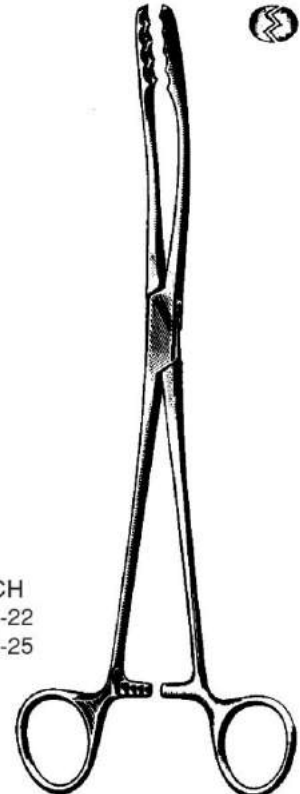

**ULRICH**  
22-161-22  
22-161-25

Sponge Holding Forceps  
Pinzas porta esponjas

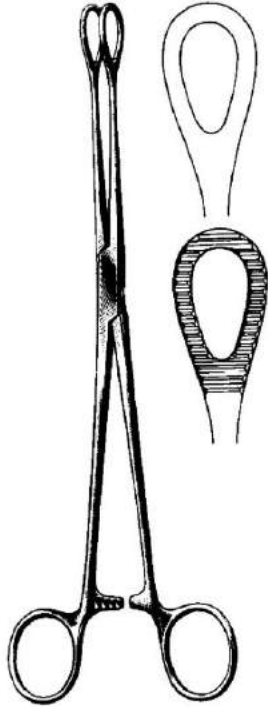

FOERSTER

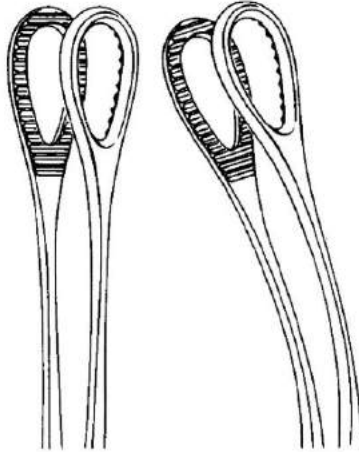

22-170-18  
22-170-20  
22-170-25

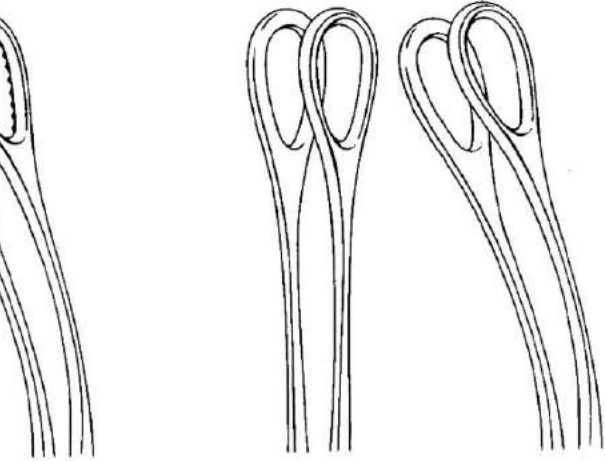

22-171-18 18 cm, 7" 22-172-18  
22-171-20 20 cm, 8" 22-172-25  
22-171-25 25 cm, 10" 22-173-18  
22-173-25

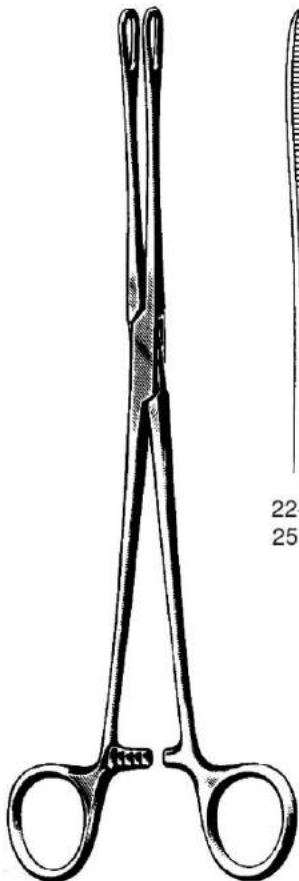

FLETCHER

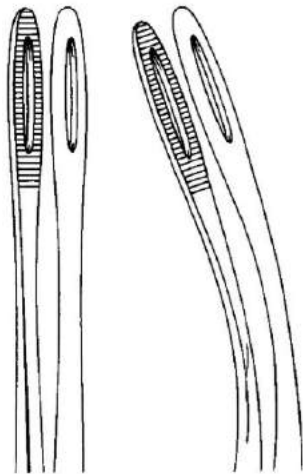

22-174-25  
25 cm, 10"

22-175-25  
25 cm, 10"

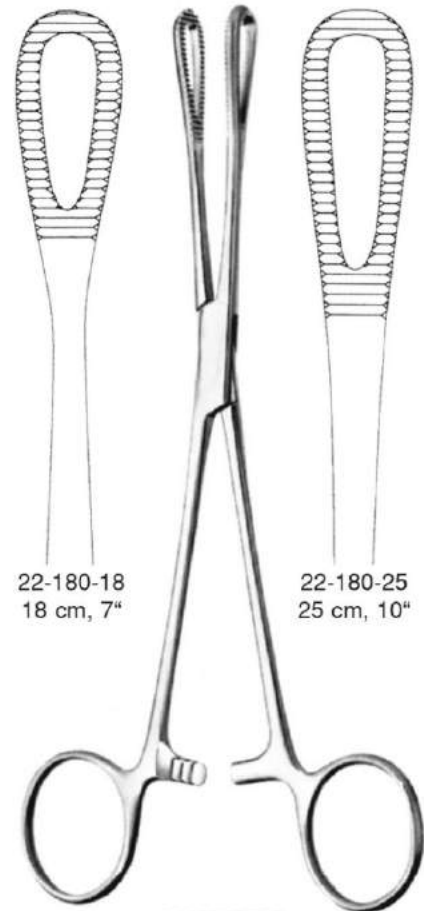

22-180-18  
18 cm, 7"

22-180-25  
25 cm, 10"

RAMPLEY





Dressing Forceps  
Pinzas porta-esponjas



**BRYANT**  
22-207-13  
13 cm, 5 1/8"



**LISTER (Sinus)**  
22-210-13 13 cm, 5 1/8"  
22-210-16 16 cm, 6 1/4"  
22-210-18 18 cm, 7"

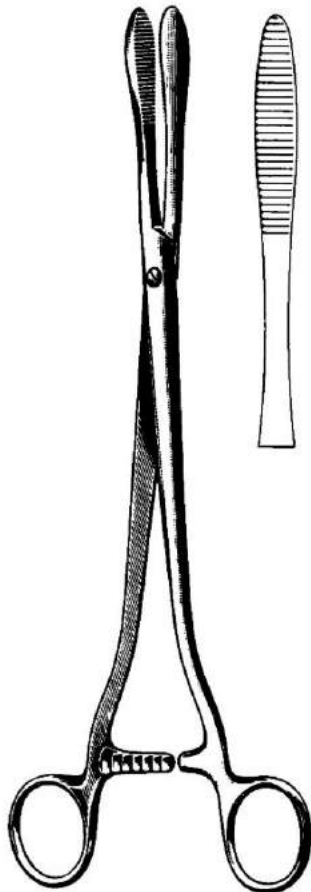

**COLLIN**  
22-220-25 25 cm, 10"



**PELKMAN**  
22-226-25 25 cm, 10"



**CHERON**  
22-229-25 25 cm, 10"

Dressing Forceps  
Pinzas para tapones

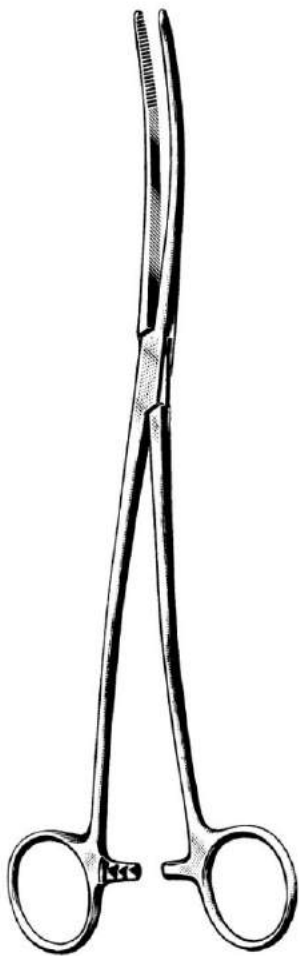

— BOZEMAN —  
22-230-26 22-231-26  
26 cm, 10 1/4"

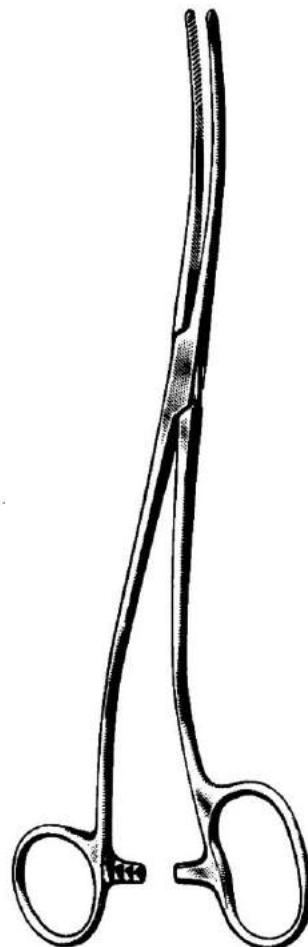

BOZEMAN  
22-233-26  
26 cm, 10 1/4"





Retractors  
Separadores

\* Set, juego, serie

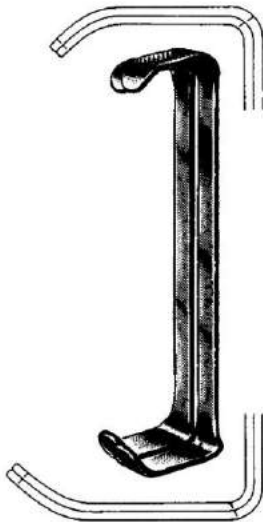

\* FARABEU  
24-102-12  
12 cm, 4 3/4"

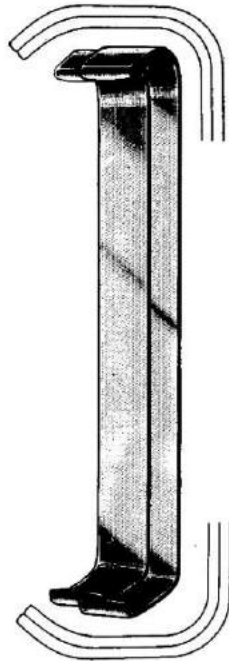

\* FARABEU  
24-102-15  
15 cm, 6"



\* COLLIN  
24-104-15  
15 cm, 6"

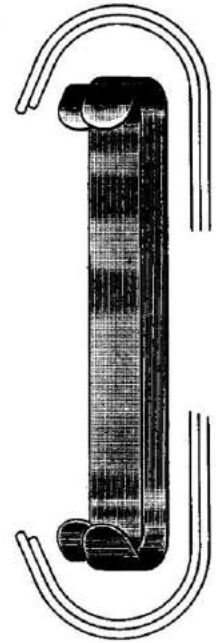

\* PARKER  
24-110-13  
13.5 cm, 5 1/4"

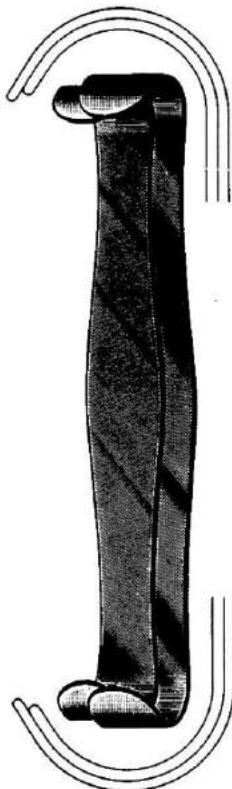

\* PARKER  
24-110-18 18 cm, 7"

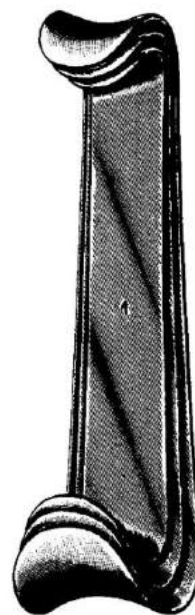

\* ROUX  
24-120-00

Fig. 1 24 x 20 mm  
Fig. 2 29 x 26 mm  
Fig. 3 35x29 mm

Fig. 1 30 x 28 mm  
Fig. 2 36 x 36 mm  
Fig. 3 38 x 43 mm

24-120-14 Fig. 1 14 cm, 5 1/2"  
24-120-15 Fig. 2 15 cm, 6"  
24-120-17 Fig. 3 17 cm, 6 3/4"



Retractors  
Separadores



ROUX-BABY  
24-122-13  
13 cm, 5 1/8"



LUER  
24-123-11  
11 cm, 4 3/8"

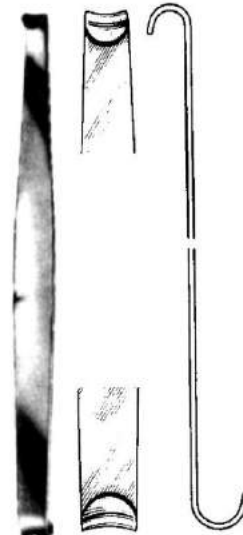

ROUX Mini  
24-124-15  
14 cm, 5 1/2"



RAGNELL  
24-125-14  
14 cm, 5 1/2"



ROSE  
24-126-13  
13 cm, 5 1/8"



CRILE  
24-127-11  
11.5 cm, 4 1/2"



Retractors  
Separadores



\* MAYO-COLLINS  
24-132-15  
15 cm, 6"



Fig. 2 25 x 24 mm  
Fig. 1 21 x 24 mm



Fig. 1 40 x 15 mm  
Fig. 2 45 x 15 mm

\* US ARMY / Parker-Langenbeck  
24-131-21 21 cm, 8 1/4"

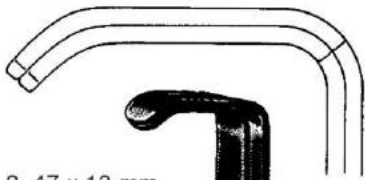

Fig. 2 47 x 13 mm  
Fig. 1 42 x 13 mm

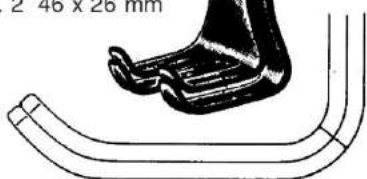
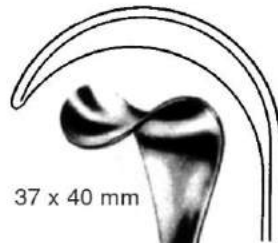

Fig. 1 42 x 26 mm  
Fig. 2 46 x 26 mm

\* MATHIEU  
24-134-20 20 cm, 8"



37 x 40 mm



30 x 31 mm

GOELET  
24-135-19 19 cm, 7 1/2"

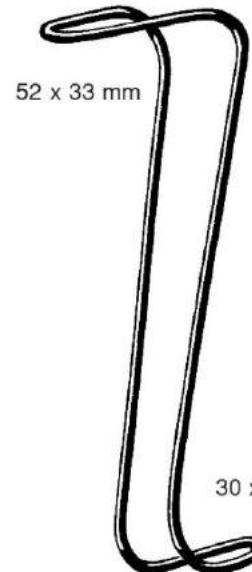

52 x 33 mm

30 x 21 mm

COLLIN-HARTMAN  
24-137-16 16 cm, 6 1/4"



Retractors  
Separadores

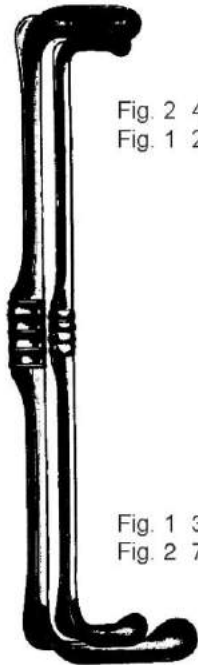
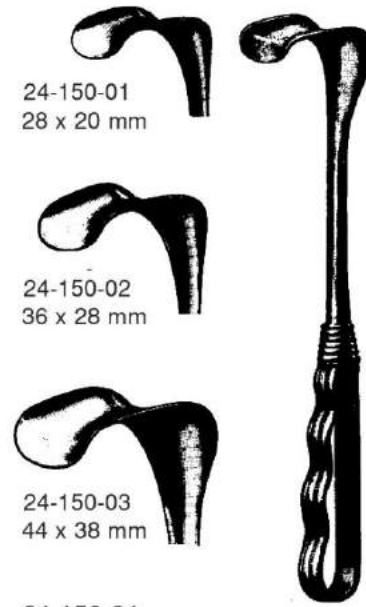

Fig. 2 49 x 38 mm  
Fig. 1 28 x 20 mm

Fig. 1 36 x 28 mm  
Fig. 2 71 x 43 mm

\* RICHARDSON-EASTMAN  
Set 24-140-00  
Fig. 1 24-140-01 26 cm, 10 1/4"  
Fig. 2 24-140-02 28 cm, 11"



24-150-01  
28 x 20 mm

24-150-02  
36 x 28 mm

24-150-03  
44 x 38 mm

24-150-04  
51 x 20 mm

RICHARDSON

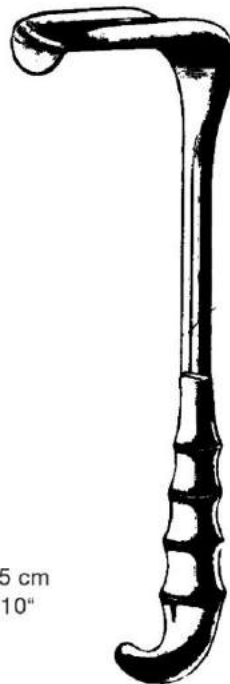

25 cm  
10"

RICHARDSON Grip  
24-152-25 20 x 25 mm  
24-152-31 25 x 31 mm  
24-152-38 38 x 38 mm  
24-152-51 19 x 51 mm  
24-152-64 41 x 64 mm

KELLY Grip  
24-158-51 38 x 51 mm  
24-158-64 51 x 64 mm  
24-158-76 64 x 76 mm  
24-158-82 70 x 82 mm



Retractors, Intestinal Spatulas  
Separadores, Espatulas intestinales

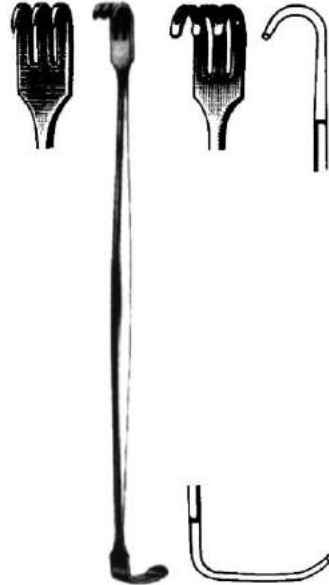

SENN-MILLER  
17 cm, 6 3/4"  
24-160-17 24-161-17

Malleable, maleables, malleabili



**RIBBON**

- 24-168-06 6 x 200 mm
- 24-168-08 8 x 200 mm
- 24-168-10 10 x 200 mm
- 24-168-12 12 x 200 mm
- 24-168-17 17 x 200 mm
- 24-168-20 20 x 200 mm
- 24-168-25 25 x 200 mm
- 24-169-25 25 x 250 mm

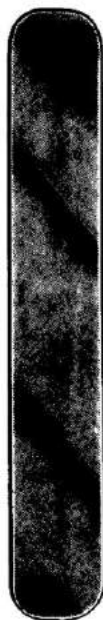

**RIBBON**

- 24-170-20 20 x 330 mm
- 24-170-25 25 x 330 mm
- 24-170-32 32 x 330 mm
- 24-170-40 40 x 330 mm
- 24-170-45 45 x 330 mm
- 24-170-50 50 x 330 mm
- 24-170-65 65 x 330 mm
- 24-170-76 76 x 330 mm



**HABERER**

- 24-174-17 17/25 x 200 mm
- 24-174-25 25/30 x 280 mm
- 24-174-37 37/45 x 300 mm
- 24-174-40 40/50 x 300 mm



**REVERDIN**

- 24-175-28  
28 cm, 11"



Retractors, Intestinal Spatulas  
Separadores, Espatulas intestinales

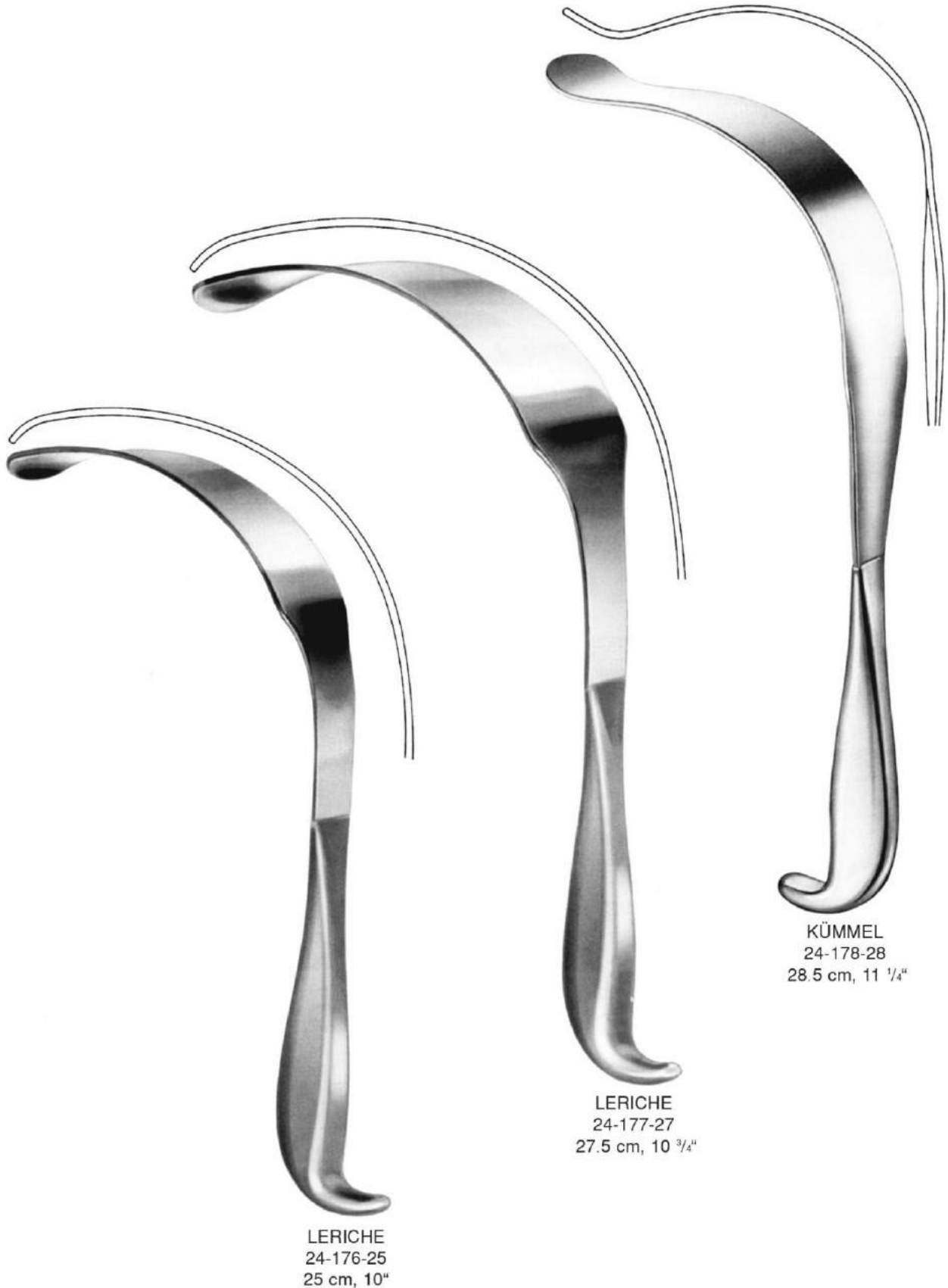

LERICHE  
24-176-25  
25 cm, 10"

LERICHE  
24-177-27  
27.5 cm, 10 <sup>3</sup>/<sub>4</sub>"

KÜMMEL  
24-178-28  
28.5 cm, 11 <sup>1</sup>/<sub>4</sub>"





Retractors  
Separadores



DEAVER  
24-180-19  
19 cm, 7 1/2"



DEAVER  
24-181-22  
21.5 cm, 8 1/2"



DEAVER  
24-181-25  
23 cm, 9"



DEAVER  
24-183-25  
30 cm, 11 3/4"



DEAVER  
24-185-25  
33 cm, 13"



DEAVER  
24-187-25  
36 cm, 14"



Retractors, Lung Spatula  
Separadores, Espátulas pulmonares



38 mm  
DEAVER  
24-187-38 38 x 300 mm



50 mm  
DEAVER  
24-187-50 50 x 300 mm



75 mm  
DEAVER  
24-187-75 75 x 300 mm



DEAVER Grip  
24-189-25 25 x 310 mm  
24-189-38 38 x 310 mm  
24-189-50 50 x 310 mm  
24-189-75 75 x 310 mm





HARRINGTON

24-191-25 25 x 230 mm  
24-191-40 40 x 320 mm  
24-191-62 62 x 320 mm



64 x 60 mm

TUFFIER  
24-192-23



## Retractors Separadores

Right  
a la derecha  
a destra  
(45 mm x 48 mm)

Right Serrated  
a la derecha, estriado  
a destra, zigginato  
(45 mm x 48 mm)

Left  
a la izquierda  
a sinistra  
(24 mm x 48 mm)

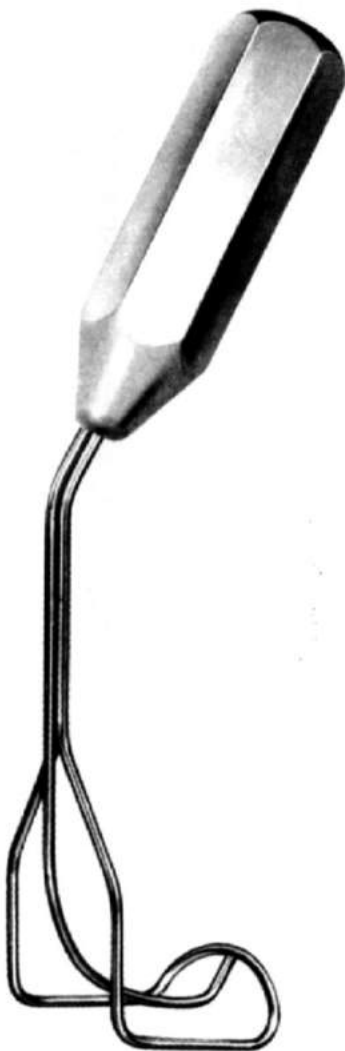

COOLEY  
24-195-01  
21.5 cm, 8 1/2"



COOLEY  
24-195-02  
21.5 cm, 8 1/2"



COOLEY  
24-195-03  
23 cm, 9"



## Nerve and Wound Hooks Canchos y ganchitos para nervios

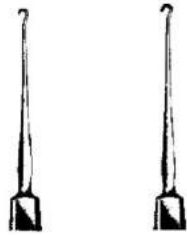

GRAEFE  
24-210-12  
Sharp  
agudo  
acuto



GRAEFE  
24-211-12  
Blunt  
romo  
smusso



12 cm, 4 3/4"



GUTHRIE  
24-212-01



GUTHRIE  
24-212-02

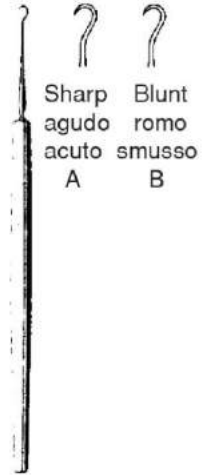

Sharp  
agudo  
acuto  
A  
Blunt  
romo  
smusso  
B

### FRAZIER

- A 24-214-13 13 cm, 5"
- A 24-214-18 18 cm, 7"
- B 24-215-13 13 cm, 5"
- B 24-215-18 18 cm, 7"



LAHEY  
12 cm, 4 3/4"



24-215-01



24-215-02



24-215-03



JOSEPH  
16 cm, 6 1/4"



24-216-01



24-216-02  
2 mm



24-216-05  
5 mm



24-216-07  
7 mm



24-216-10  
10 mm



KLEINERT-KUTZ  
13 cm, 5 1/8"



24-217-03



24-217-05



24-217-07



## Nerve and Wound Hooks Canchos y ganchitos para nervios

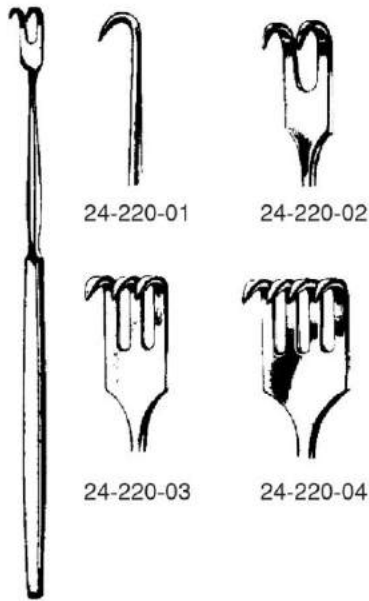

Rigid Neck Sharp  
16 cm, 6 1/4"

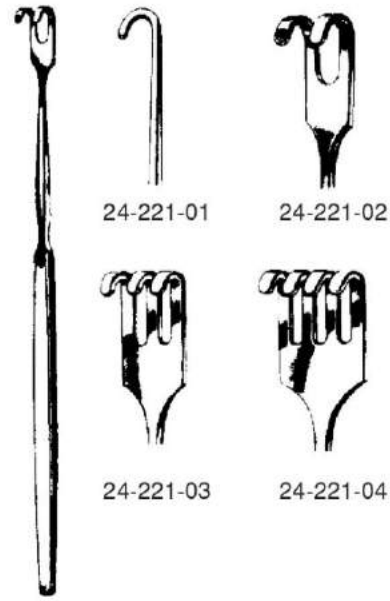

Rigid Neck Blunt  
16 cm, 6 1/4"

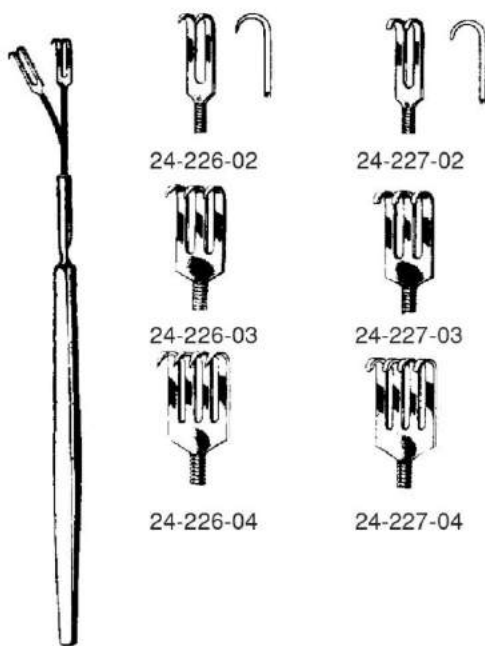

Flexible Neck  
16 cm, 6 1/4"



KLAPP  
17.5 cm, 6.9"

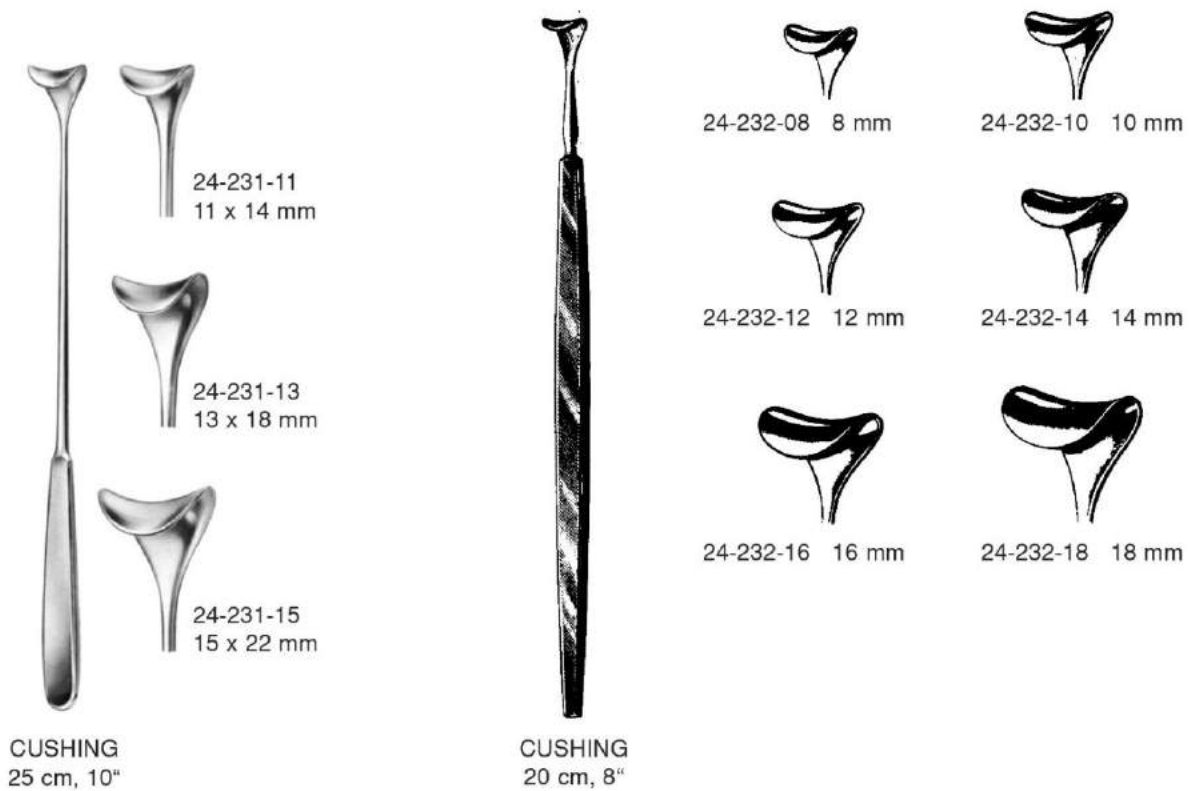
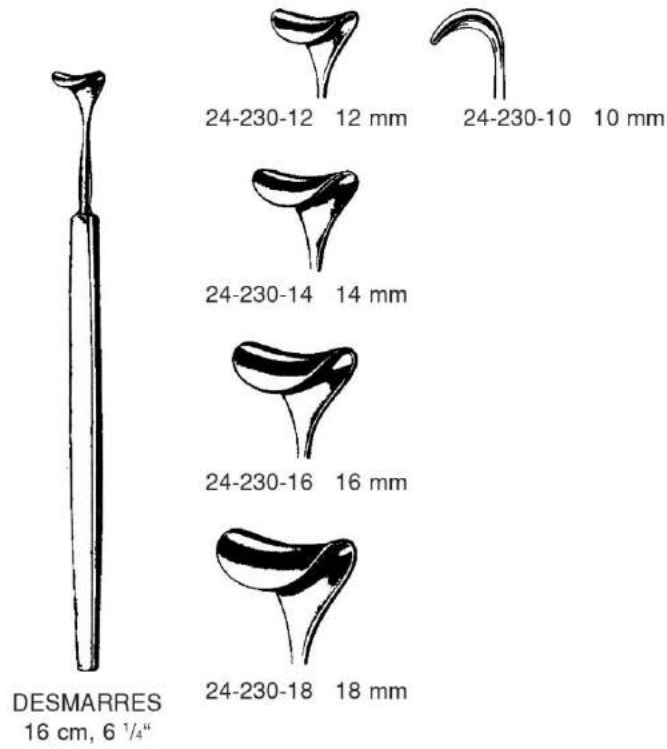

Retractors  
Separadores



CUSHING  
24 cm, 9 1/2"

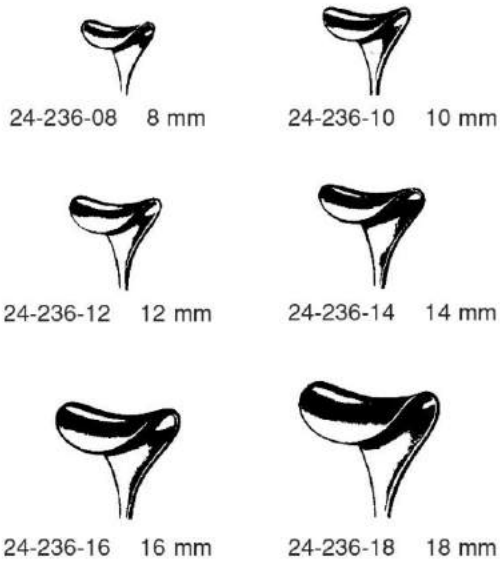

Malleable  
maleable  
malleabile

GIL-VERNET  
24-233-08 to 24-233-23

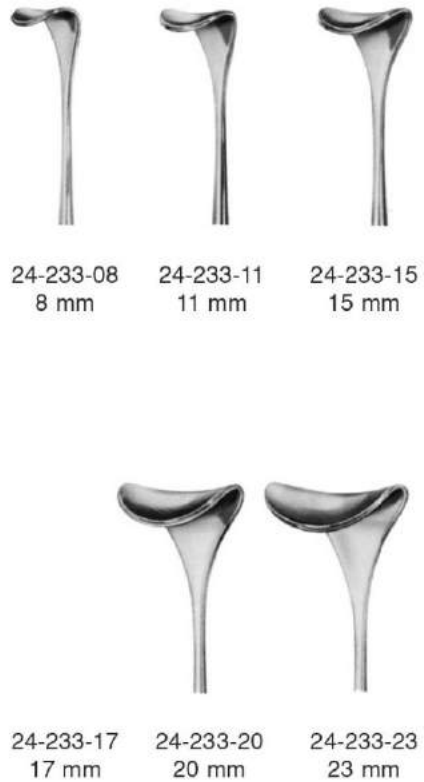



Retractors  
Separadores



CUSHING  
24-234-20  
20 cm, 8"



CUSHING  
24-235-21  
21.5 cm, 8 1/2"



KOENIG  
18 cm, 7"



24-236-01  
13 x 13 mm



24-236-02  
12 x 16 mm



SENN-GREEN  
15 cm, 6"



24-240-10 10 x 6 mm



24-240-20 20 x 6 mm



LANGENBECK-GREEN  
16 cm, 6 1/4"



24-250-16  
16 x 6 mm



24-250-24  
24 x 6 mm

USA  
Pattern



VOLKMAN  
11.5 cm, 4 1/2"



24-270-02



24-271-02



24-270-03



24-271-03



24-270-04



24-271-04



24-270-06



24-271-06



Retractors  
Separadores



24-280-01



24-280-02



24-280-03



24-280-04



24-280-06



Sharp  
agudo  
acuto



24-281-01



24-281-02



24-281-03



24-281-04



24-281-06

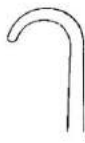

Blunt  
romo  
smusso



24-282-02



24-282-03



24-282-04



24-282-06



Semi-Sharp  
medio romo  
mezzo smusso



VOLKMAN  
21.5 cm, 8 1/2"

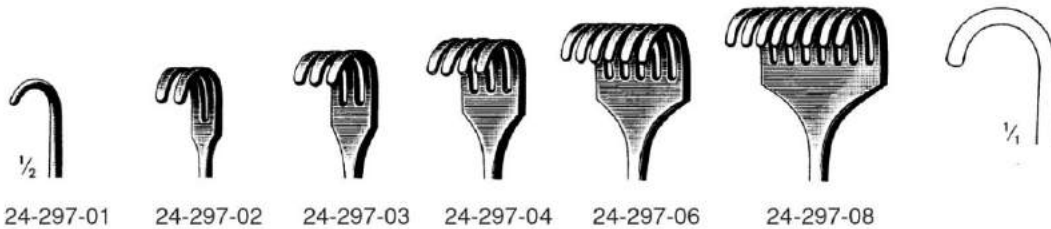
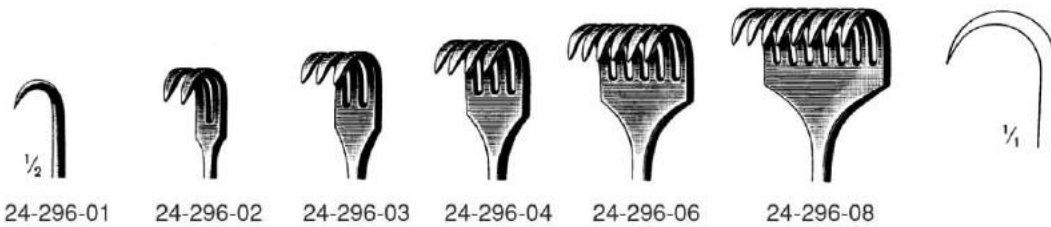

KOCHER  
24-296-01 to 24-297-08  
22 cm, 8 3/4"



## Retractors, Bone Retractors Separadores, Separadores oseos



23 mm

Sharp  
agudo  
acuto

VOLKMAN  
24-298-01 23 cm, 9"



23 mm

Blunt  
romo  
smusso

VOLKMAN  
24-299-01 23 cm, 9"

Teeth  
Dientes  
Denti



2



3



4

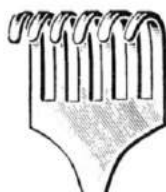

6

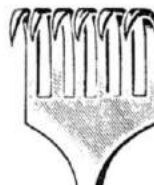

6



4



3



2

Blunt  
romo  
smusso

24-301-02 8 x 8 mm  
24-301-03 8 x 13 mm  
24-301-04 8 x 18 mm  
24-301-06 8 x 28 mm

Sharp  
agudo  
acuto

24-300-02 8 x 8 mm  
24-300-03 8 x 13 mm  
24-300-04 8 x 18 mm  
24-300-06 8 x 28 mm

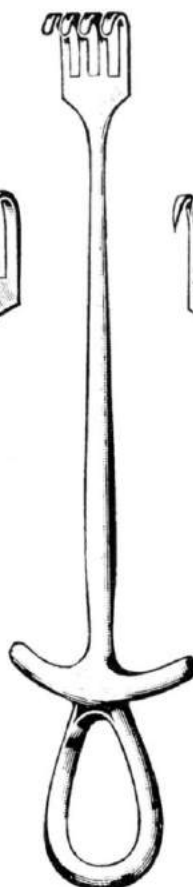

MURPHY  
19.4 cm 7 5/8"



## Retractors Separadores



MEYERDING  
18 cm, 7"



24-302-01 18 x 7 mm



24-302-04 7 x 4 mm



24-302-02 16 x 5 mm



24-302-05 10 x 3 mm



24-302-03 7 x 4 mm



24-302-06 10 x 4 mm



28x6 mm



LAHEY  
24-304-19  
19 cm, 7 1/2"



12x14 mm



LITTLE  
24-306-20  
20 cm, 8"



STRANDELL-STILLE  
17 cm, 6 3/4"



24-307-01



24-307-02



Retractors  
Separadores

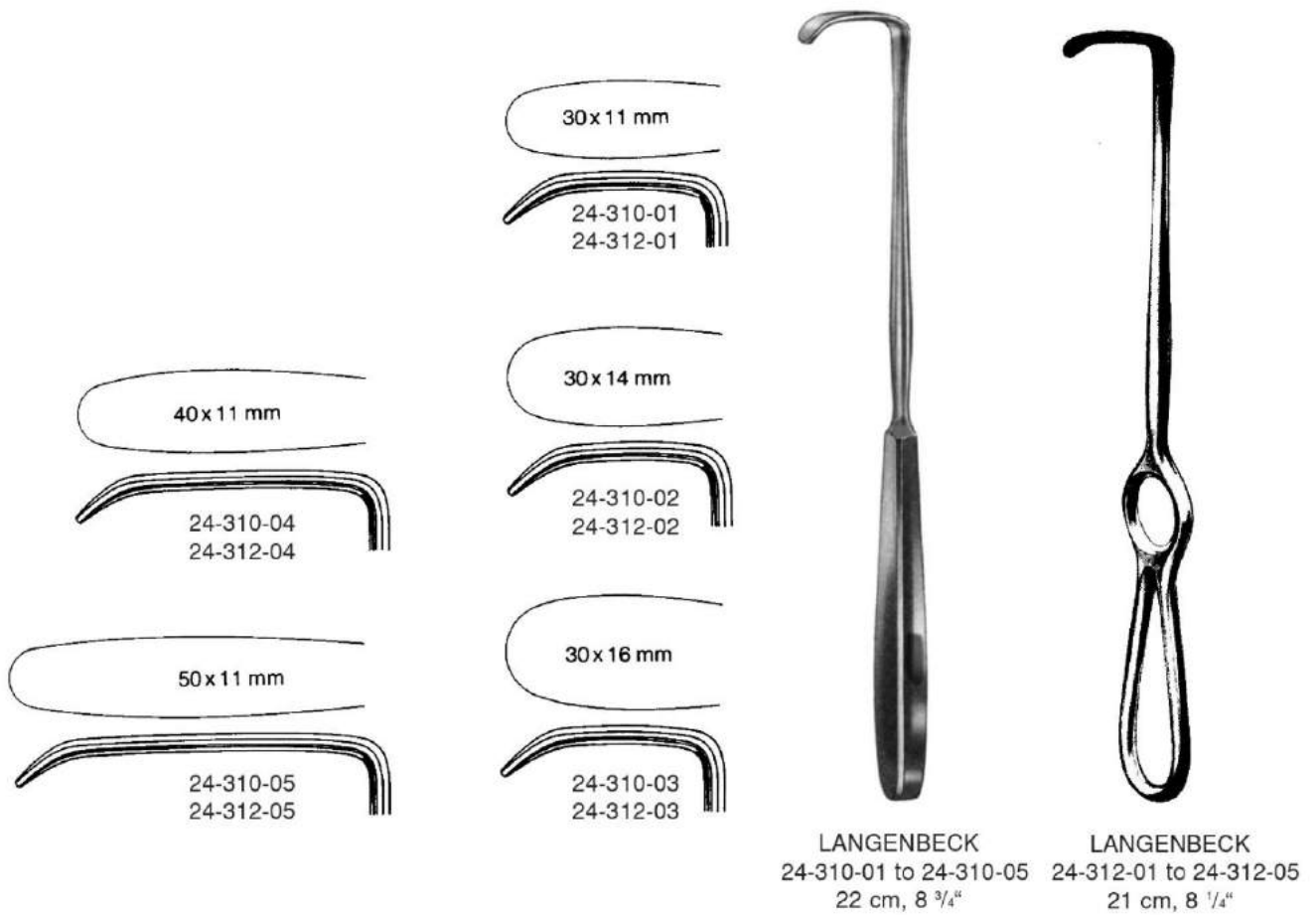

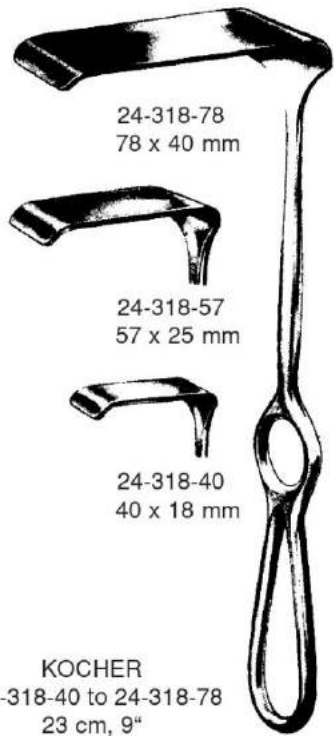
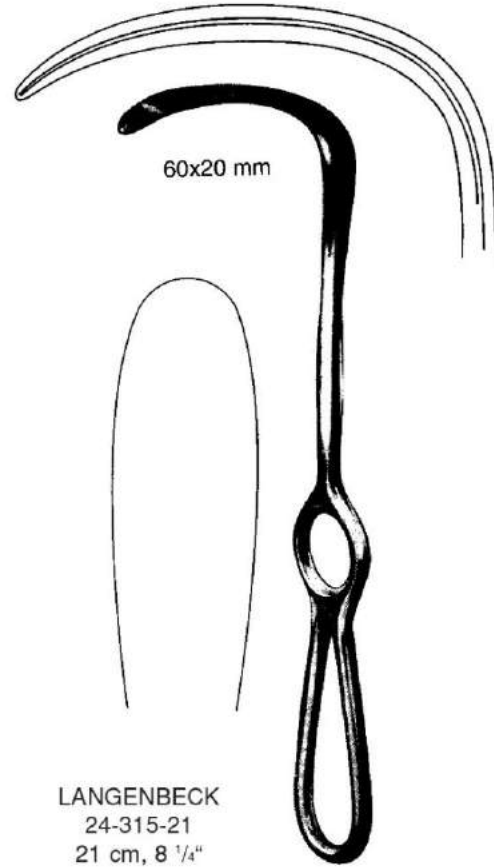
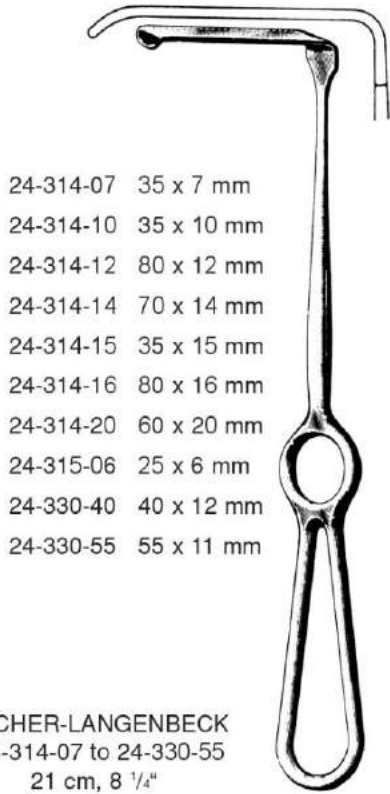





## Retractors Separadores



24-344-14  
14 x 17 mm  
21.5 cm, 8 1/2"



24-344-20  
20 x 22 mm  
22 cm, 8 3/4"





24-344-26  
26 x 30 mm  
23.5 cm, 9 1/4"



MIDDELDORPF  
24-344-14 to 24-344-26

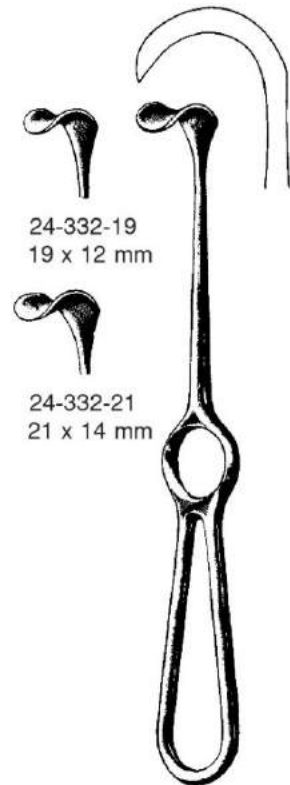

KOCHER  
24-340-10 40 x 10 mm  
24-340-15 40 x 15 mm  
24-340-20 40 x 20 mm  
22 cm, 8 3/4"

24-332-19  
19 x 12 mm



24-332-21  
21 x 14 mm

KOCHER  
24-332-19 24-332-21  
19 cm, 7 1/2"



MIDDELDORPF  
24-345-01 45 x 45 mm  
25.5 cm, 10"



24-345-02  
45 x 50 mm



24-345-03  
55 x 70 mm



20 x 25 mm

GREEN  
24-348-22  
22 cm, 8 3/4"





Retractors  
Separadores



35 x 8 mm

ZENKER  
24-350-35  
25 cm, 10"



60 x 12 mm

ZENKER  
24-350-60  
26 cm, 10 1/4"



75 x 12 mm

ZENKER  
24-350-75  
2.5 cm, 10.8"



Retractors  
Separadores



ISRAEL  
24-364-40 40 x 40 mm  
25 cm, 10"

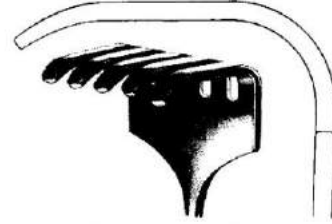

24-364-50 45 x 50 mm

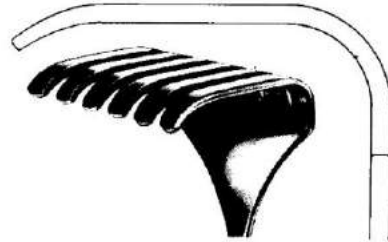

24-364-60 50 x 60 mm



24-364-70 70 x 70 mm

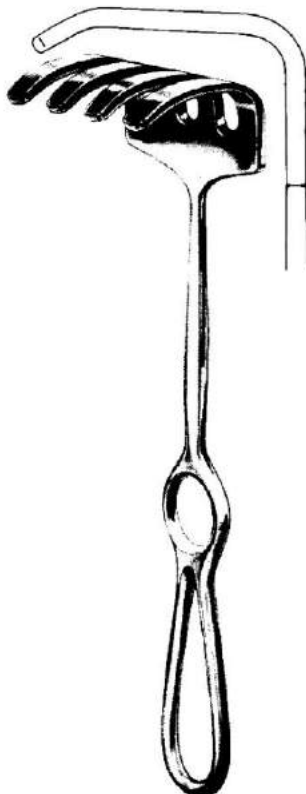

OLLIER  
24-360-04 22.5 cm, 8.9"

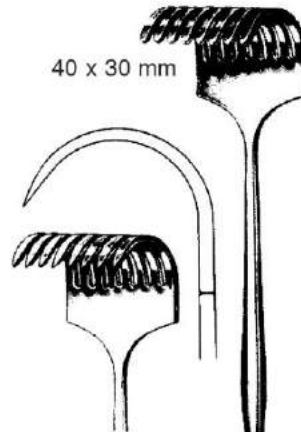

40 x 30 mm

Sharp  
agudo  
acuto

Blunt  
romo  
smusso



KOERTE  
24-366-08 23.5 cm, 9 1/4" 24-367-08



Retractors  
Separadores

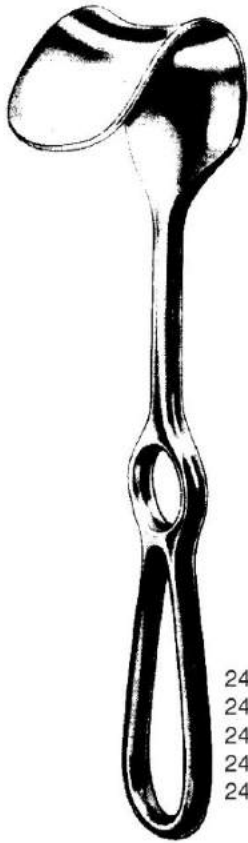

**FRITSCH**  
 24-370-40 45 x 40 mm  
 24-370-50 45 x 50 mm  
 24-370-60 45 x 60 mm  
 24-370-75 45 x 75 mm  
 24-370-85 65 x 85 mm  
 24 cm, 9 1/2"



**KOCHER**  
 24-372-22  
 70 x 25 mm  
 22.5 cm, 8.9"

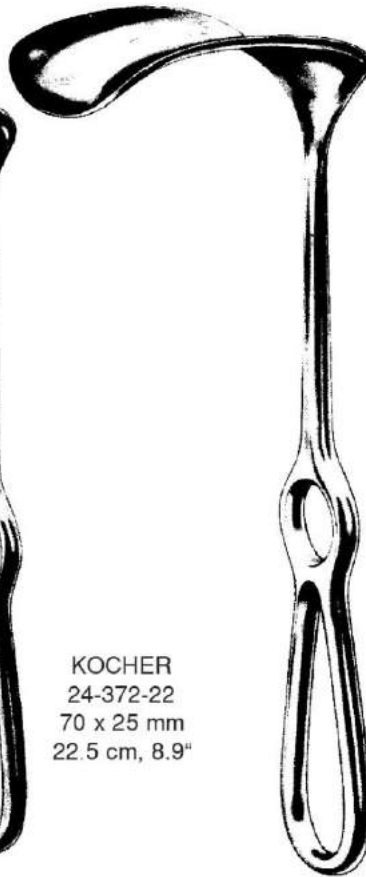

**KOCHER**  
 24-374-45 80 x 45 mm  
 24-374-55 80 x 55 mm  
 24-374-65 80 x 65 mm  
 25 cm, 10"

50 x 85 mm

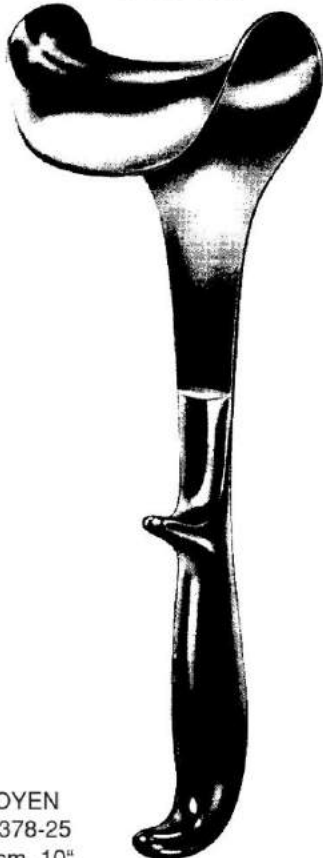

**DOYEN**  
 24-378-25  
 25 cm, 10"

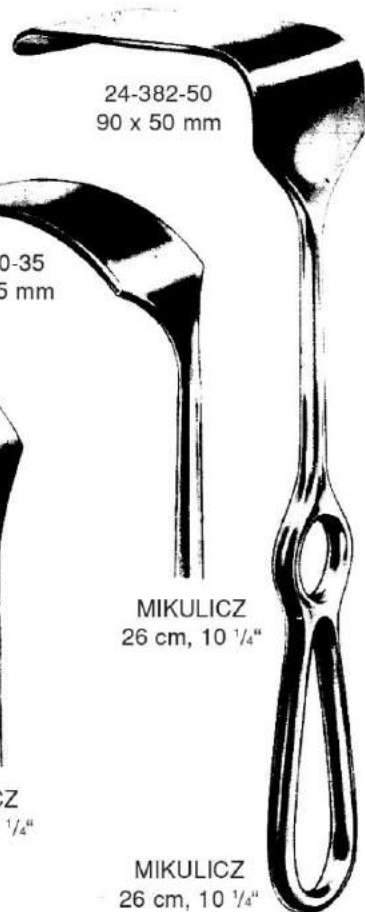

24-382-50  
 90 x 50 mm

24-380-35  
 95 x 35 mm

**MIKULICZ**  
 26 cm, 10 1/4"

**MIKULICZ**  
 26 cm, 10 1/4"

**MIKULICZ**  
 26 cm, 10 1/4"



Retractors  
Separadores



24-388-40 70 x 40 mm  
24-388-50 70 x 50 mm  
24-388-65 70 x 65 mm



MORRIS  
24.5 cm  
9 3/4"



SIMON  
24-480-22 115 x 22 mm  
24-480-27 115 x 27 mm  
28 cm, 11"



KELLY  
24-385-38 160 x 38 mm  
24-385-57 160 x 57 mm  
27 cm, 10 1/2"



24-482-82  
82 x 28 mm



24-482-73  
73 x 28 mm



24-482-45  
45 x 25 mm

HEANEY  
24-482-45 to 24-482-82  
27 cm, 10 1/2"

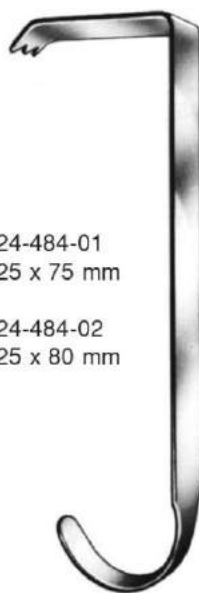

24-484-01  
25 x 75 mm

24-484-02  
25 x 80 mm

HIBBS  
24 cm, 9 1/2"



25 x 37 mm

SAUERBRUCH  
24-492-25  
25 cm, 10"



Retractors  
Separadores

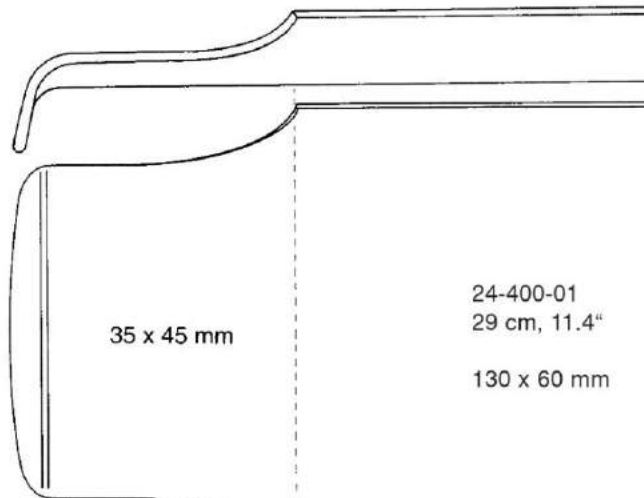

35 x 45 mm

24-400-01  
29 cm, 11.4"  
130 x 60 mm

Pelvic Retractor  
Retractor de pelvis  
Divaricatori pelvici

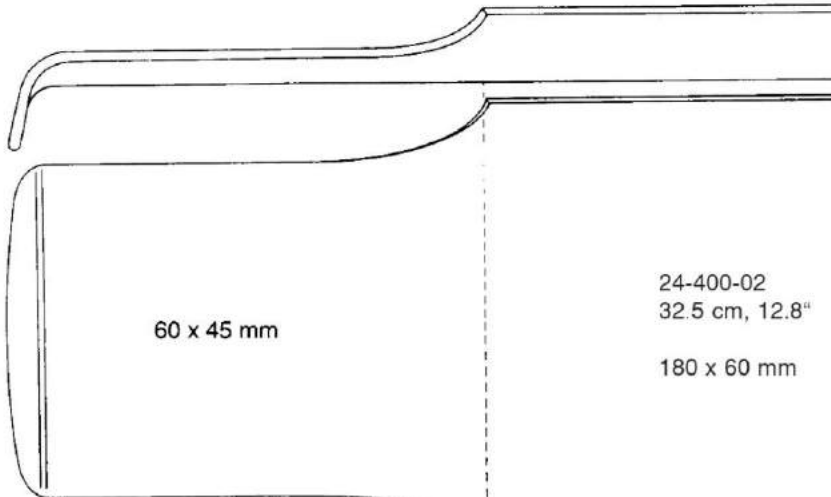

60 x 45 mm

24-400-02  
32.5 cm, 12.8"  
180 x 60 mm

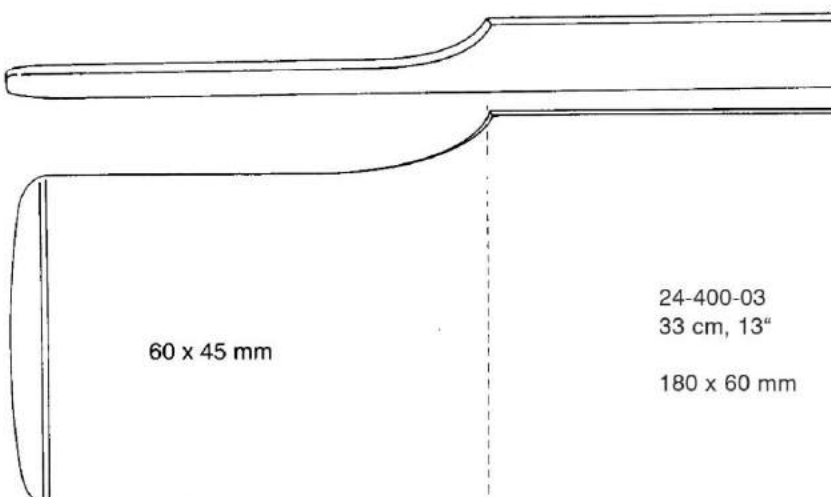

60 x 45 mm

24-400-03  
33 cm, 13"  
180 x 60 mm



ST. MARKS  
24-400-01 to 24-400-03

Retractors  
Separadores

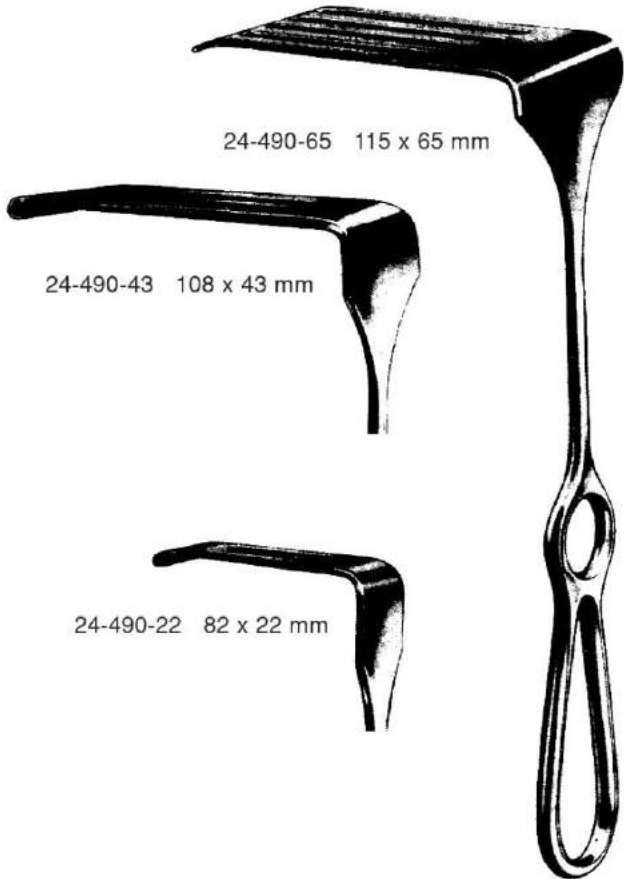

24-490-65 115 x 65 mm

24-490-43 108 x 43 mm

24-490-22 82 x 22 mm

CORYLLOS (Thorax)  
24-490-22 to 24-490-65  
24 cm, 9 1/2"

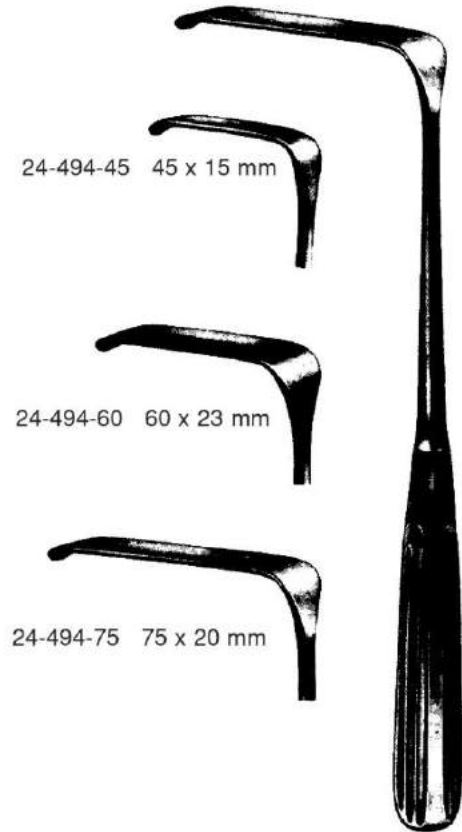

24-494-45 45 x 15 mm

24-494-60 60 x 23 mm

24-494-75 75 x 20 mm

SAUERBRUCH  
24-494-45 to 24-494-75  
22.5 cm, 8.9"



DAVIDSON (Scapula)  
24-496-50 75 x 50 mm



DAVIDSON (Scapula)  
24-496-90 75 x 90 mm



## Retractors Separadores



BRUNNER  
25 cm, 10"

24-493-80	80 x 20 mm
24-494-00	100 x 25 mm
24-494-12	120 x 25 mm
24-494-13	130 x 30 mm
24-494-14	140 x 30 mm
24-494-16	160 x 30 mm
24-494-18	180 x 30 mm

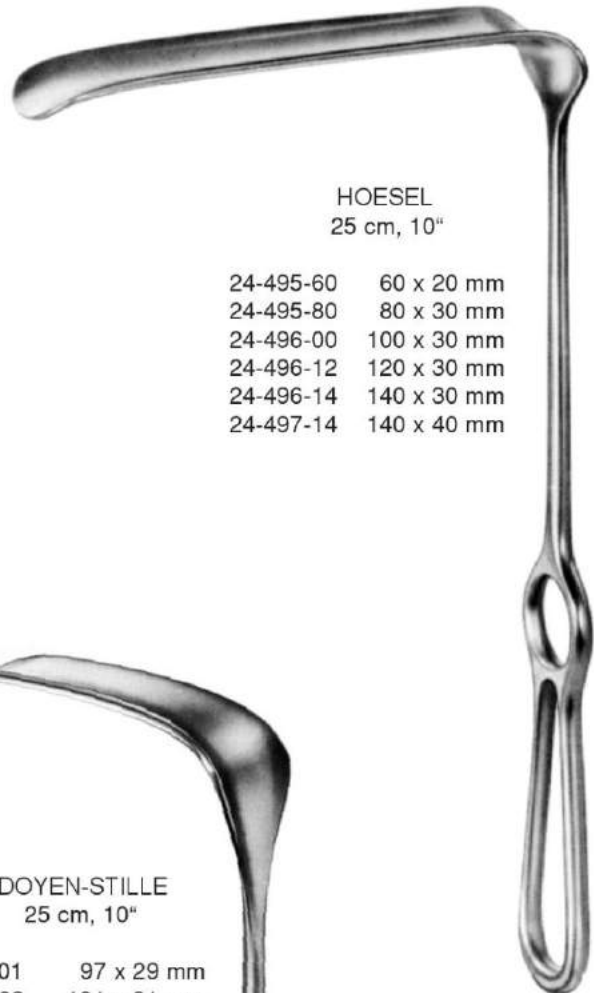

HOESEL  
25 cm, 10"

24-495-60	60 x 20 mm
24-495-80	80 x 30 mm
24-496-00	100 x 30 mm
24-496-12	120 x 30 mm
24-496-14	140 x 30 mm
24-497-14	140 x 40 mm

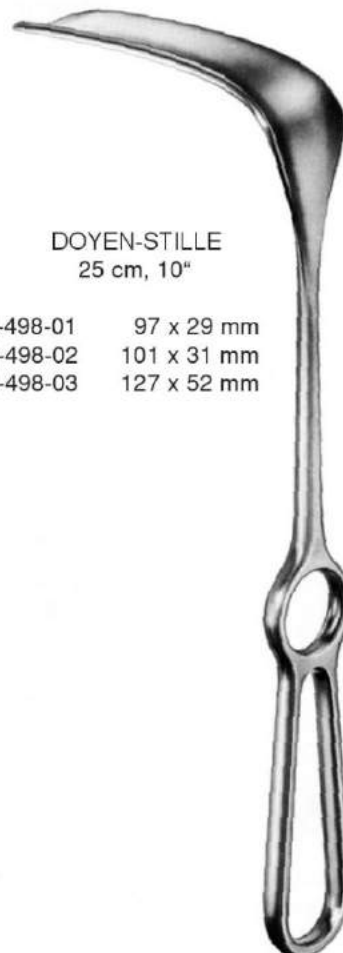

DOYEN-STILLE  
25 cm, 10"

24-498-01	97 x 29 mm
24-498-02	101 x 31 mm
24-498-03	127 x 52 mm



## Retractors Separadores

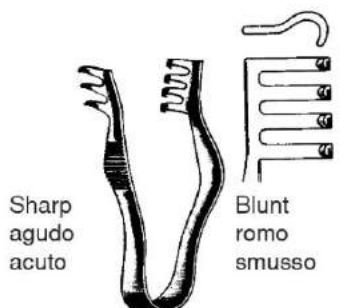

Sharp agudo acuto  
Blunt romo smusso

**FINSEN**  
24-610-07 7 cm, 2 3/4" 24-611-07

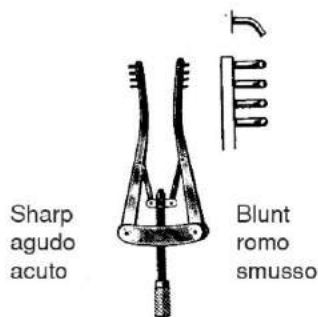

Sharp agudo acuto  
Blunt romo smusso

**ALM**  
24-620-07 7 cm, 2 3/4" 24-621-07  
24-620-10 10 cm, 4" 24-621-10

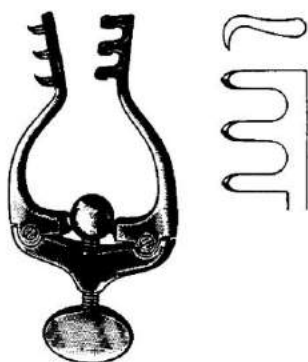

**JANSEN**  
24-630-10  
10 cm, 4"

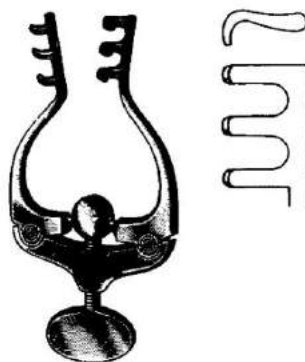

**JANSEN**  
24-631-10  
10 cm, 4"

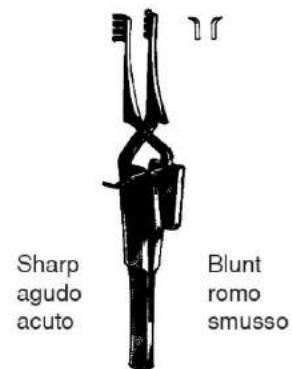

Sharp agudo acuto  
Blunt romo smusso

**HOLZHEIMER**  
24-634-10 24-635-10  
10 cm, 4"



**PERKINS**  
24-636-14  
14 cm, 5 1/8"

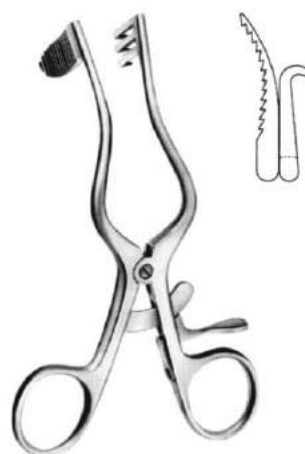

**PERKINS**  
24-637-14  
14 cm, 5 1/8"





## Retractors Separadores



Sharp  
agudo  
acuto

Blunt  
romo  
smusso



SCALP-CONTOUR  
24-640-14 24-641-14  
13.5 cm 5 1/4"

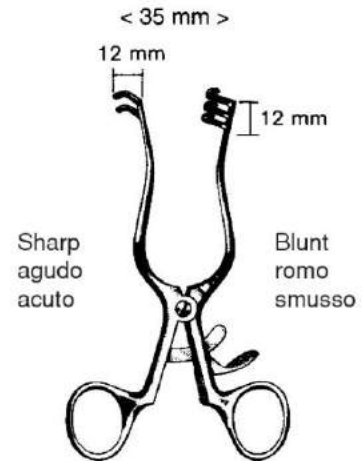

Sharp  
agudo  
acuto

Blunt  
romo  
smusso

WEITLANER  
24-650-12 24-651-12  
11.5 cm, 4 1/2"

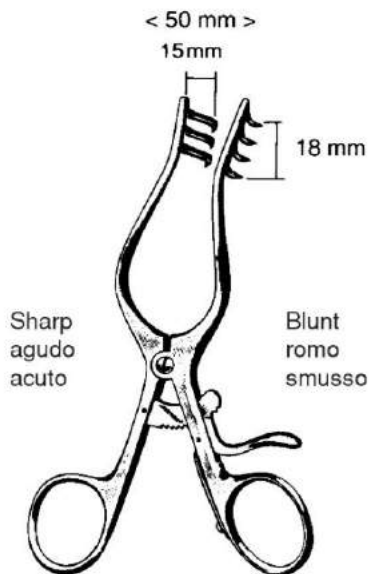

Sharp  
agudo  
acuto

Blunt  
romo  
smusso

WEITLANER-WULLSTEIN  
24-654-13 24-655-13  
13 cm, 5 1/8"

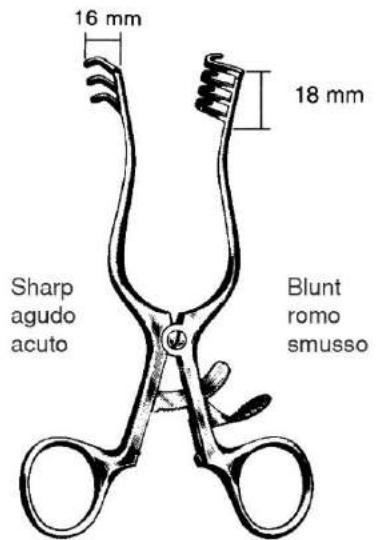

Sharp  
agudo  
acuto

Blunt  
romo  
smusso

WEITLANER  
24-670-14 14.0 cm, 5 1/2" 24-671-14  
24-670-16 16.5 cm, 6 1/2" 24-671-16  
24-670-20 20.0 cm, 8" 24-671-20  
24-670-24 24.0 cm, 9 1/2" 24-671-24



## Retractors Separadores

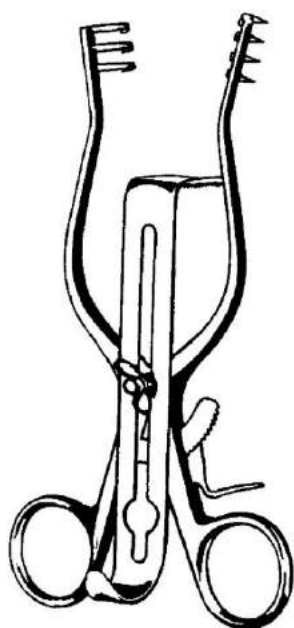

**HENLEY**  
24-675-00 to 24-678-06  
16.5 cm, 6 1/2"

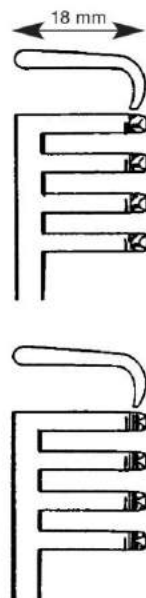

24-675-00 Complete, Blunt, 3x4 Teeth and 3 Blades  
24-675-00 completo, romo, 3x4 dientes y 3 valvas  
24-675-00 completo, smusso, 3x4 d. e 3 valve

24-676-00 Complete, Sharp, 3x4 Teeth and 3 Blades  
24-676-00 completo, agudo, 3x4 dientes y 3 valvas  
24-676-00 completo con retr. acuto 3x4 d. e 3 valve

24-678-05 Retractor Only, Blunt 3x4 Teeth  
24-678-05 Separador solo, romo, 3x4 dientes  
24-678-05 Retrattore solo, smusso 3x4 denti

24-678-06 Retractor Only, Sharp 3x4 Teeth  
24-678-06 Separador solo, agudo, 3x4 dientes  
24-678-06 Retrattore solo, acuto 3x4 denti



24-677-19  
16 x 19 mm

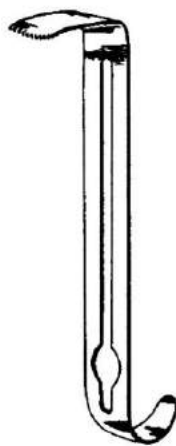

24-677-25  
16 x 25 mm

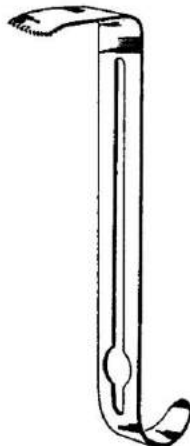

24-677-32  
16 x 32 mm



Retractors  
Separadores



**PLESTER**  
24-672-11 11 cm, 4 3/8"  
Solid Blade Right



**PLESTER**  
24-673-11 11 cm, 4 3/8"  
Solid Blade Left



**MOLLISON**  
24-674-15 15 cm, 6"

9 mm

Sharp  
agudo  
acuto



**WULLSTEIN**  
24-675-13  
13 cm, 5 1/8"



**PLESTER**  
24-677-13  
13 cm, 5 1/8"

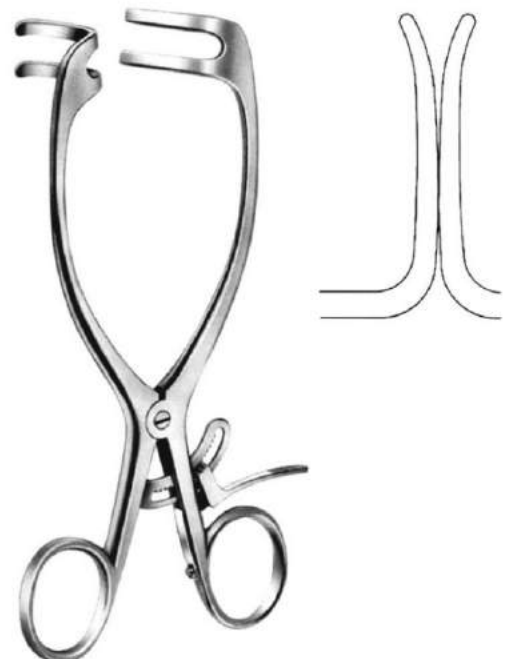

**MAYO-ADAMS**  
24-678-16  
16.5 cm, 6 1/2"

Retractors  
Separadores

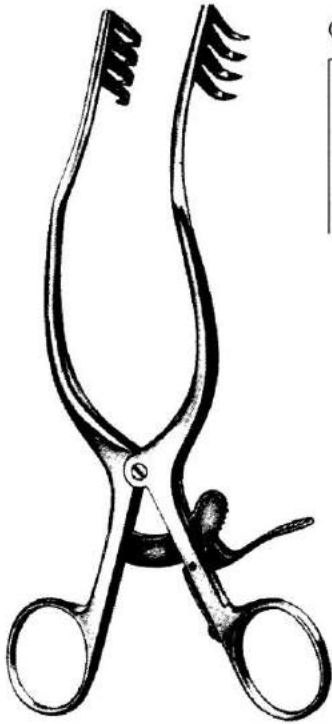

ANDERSON-ADSON  
24-679-20 19.5 cm, 7 <sup>3</sup>/<sub>4</sub>"



NORFOLK-NORWICH  
24-679-22 22 cm, 8 <sup>3</sup>/<sub>4</sub>"



Sharp agudo acuto 24-680-19 19 cm, 7 <sup>1</sup>/<sub>2</sub>"      Blunt romo smusso 24-681-19



TRAVERS  
24-681-21 21.5 cm, 8 <sup>1</sup>/<sub>2</sub>"

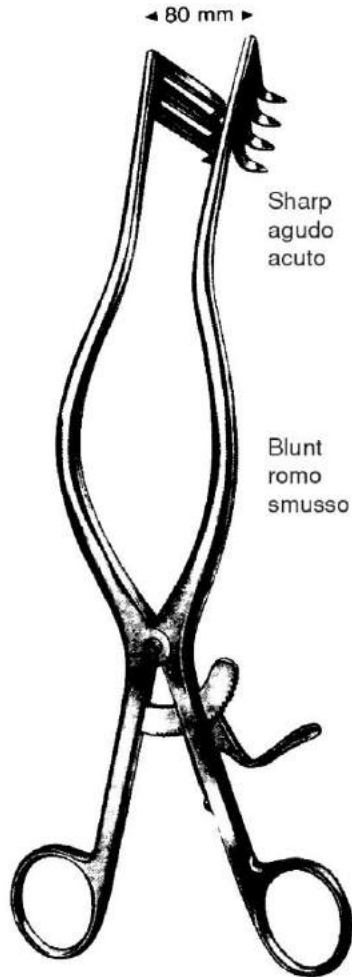

Sharp  
agudo  
acuto

Blunt  
romo  
smusso

ADSON  
24-682-26 24-683-26  
26.5 cm, 10 1/2"

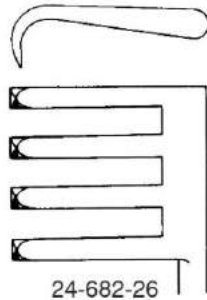

24-682-26

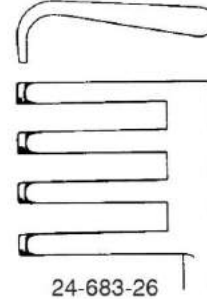

24-683-26

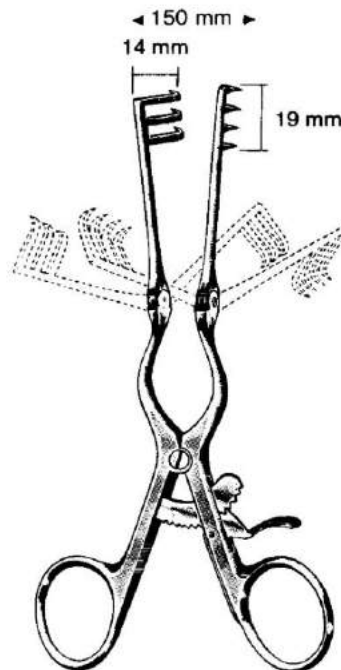

24-684-14	14 cm, 5 1/2"
24-684-16	16 cm, 6 1/4"
24-684-20	20 cm, 8"
24-684-26	26 cm, 10 1/4"

Sharp  
agudo  
acuto

24-685-14	14 cm, 5 1/2"
24-685-16	16 cm, 6 1/4"
24-685-20	20 cm, 8"
24-685-26	26 cm, 10 1/4"

Blunt  
romo  
smusso

ADSON

Retractors  
Separadores

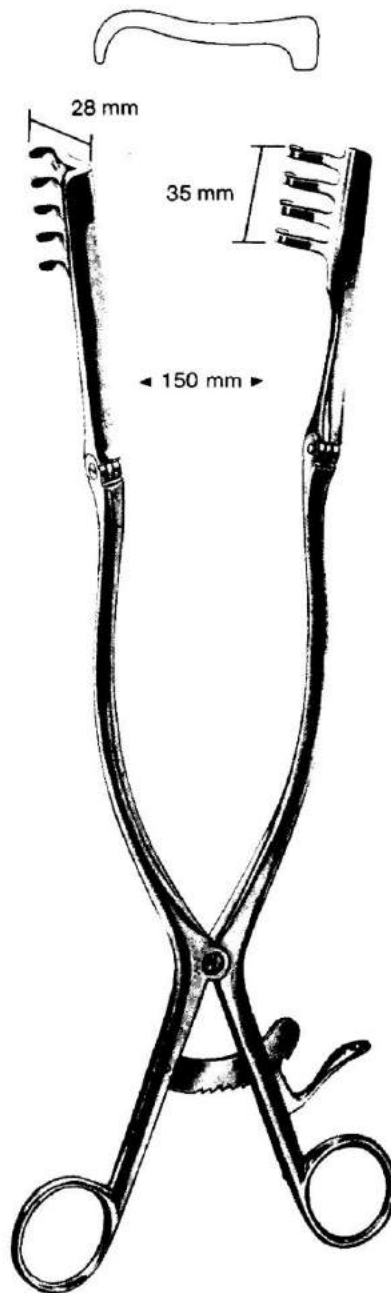

ADSON  
24-686-32  
32 cm, 12 3/4"



BECKMAN-ADSON  
31 cm, 12 1/4"

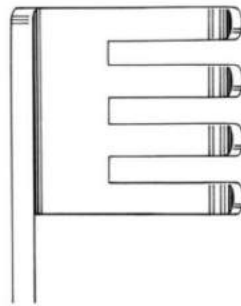

24-687-01  
25 x 27 mm

Blunt  
romo  
smusso

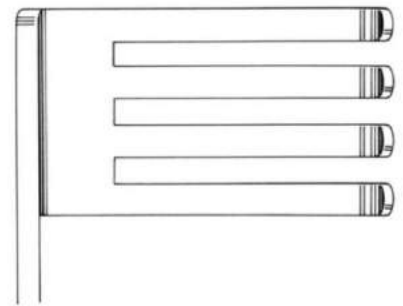

24-688-01  
45 x 27 mm

Blunt  
romo  
smusso

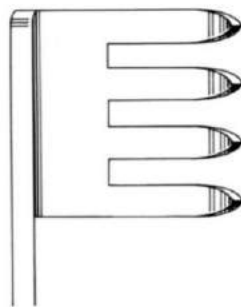

24-687-02  
25 x 27 mm

Sharp  
agudo  
acuto

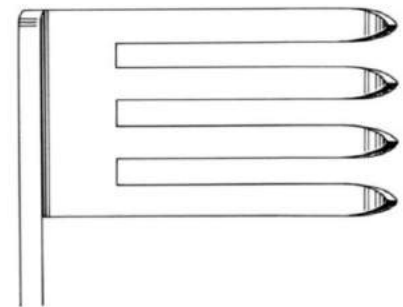

24-688-02  
45 x 27 mm

Sharp  
agudo  
acuto



Retractors  
Separadores

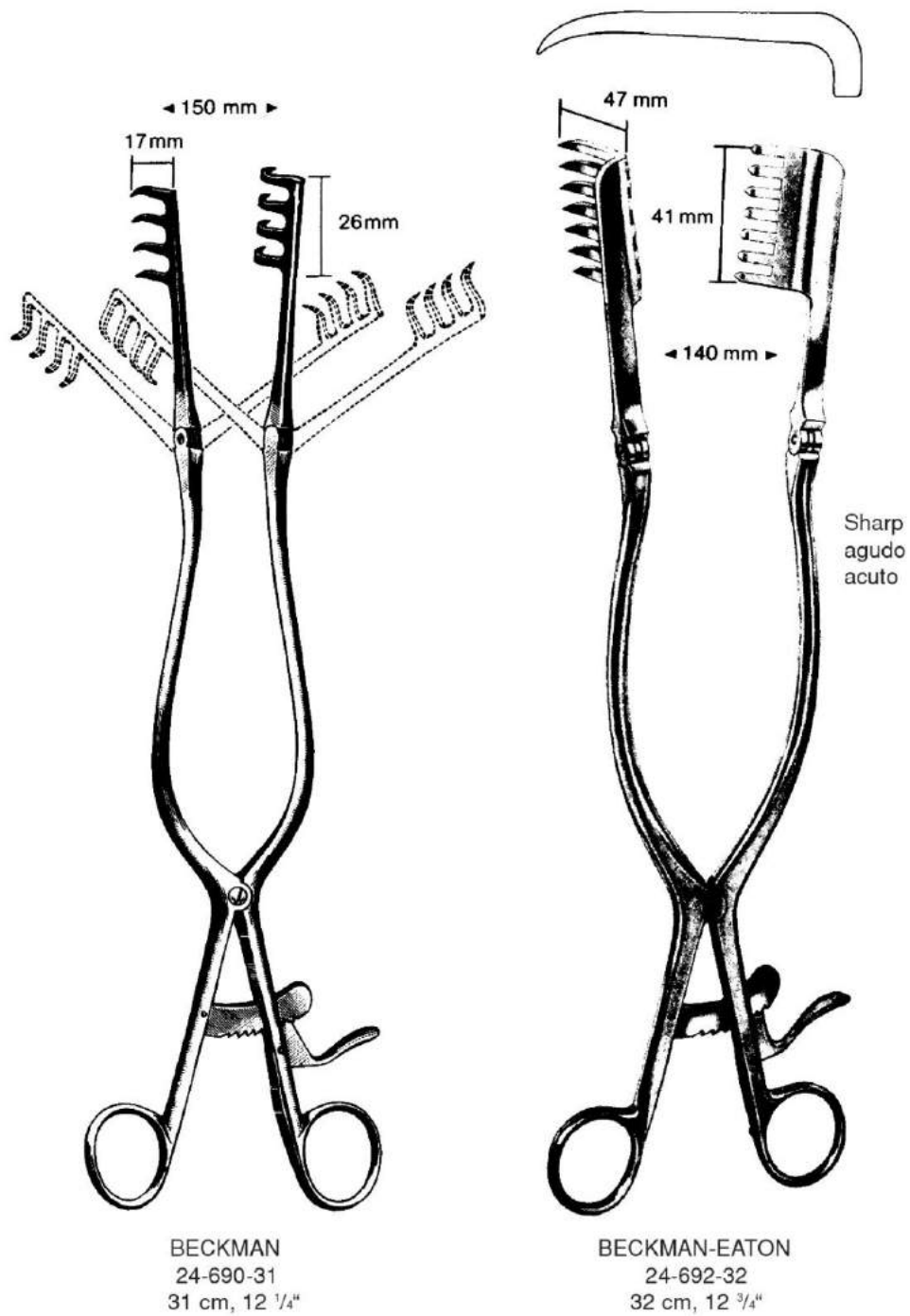



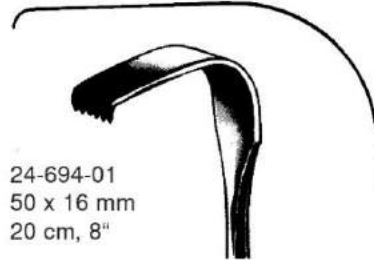

24-694-01  
50 x 16 mm  
20 cm, 8"

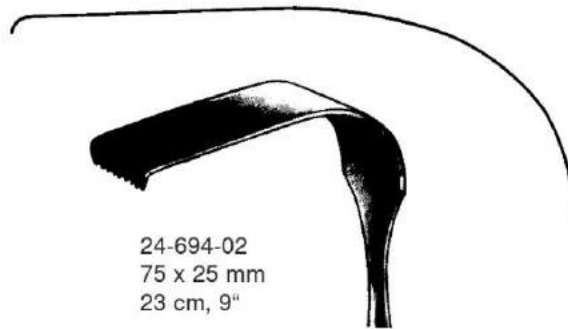

24-694-02  
75 x 25 mm  
23 cm, 9"



24-694-03  
90 x 50 mm  
24 cm, 9 1/2"

MEYERDING



Retractors  
Separadores

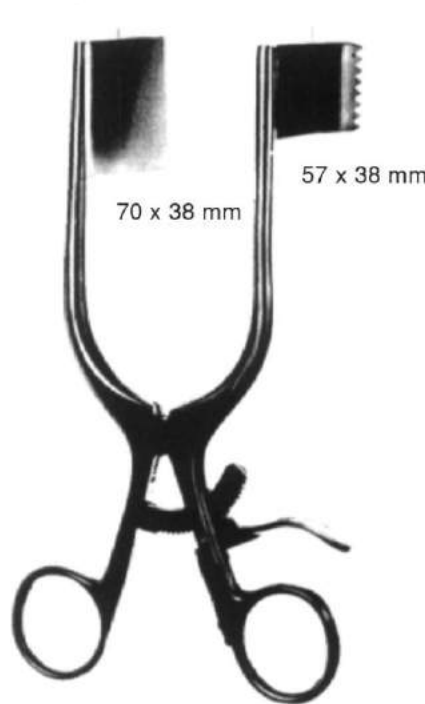

DARLING  
24-696-18 18 cm, 7"

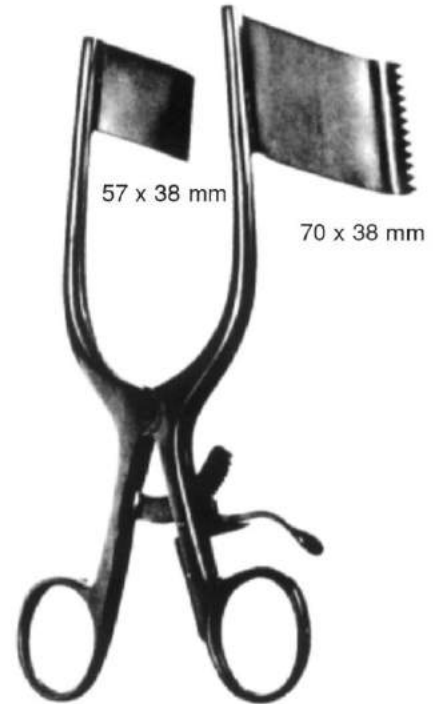

DARLING  
24-698-18 18 cm, 7"



20 mm wide



24-710-40 40 mm



24-710-45 45 mm



24-710-50 50 mm



24-710-55 55 mm



24-710-60 60 mm  
Sharp

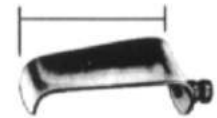

24-711-40 40 mm



24-711-45 45 mm



24-711-50 50 mm



24-711-55 55 mm



24-711-60 60 mm  
Blunt

24-710-00 (24-710-40 to 24-710-60)  
Retractor Complete with 5 Blades Sharp  
Separador completo con 5 valvas agudas  
Divaricatore completo con 5 valve acute

24-712-00 (24-711-40 to 24-711-60)  
Retractor Complete with 5 Blades Blunt  
Separador completo con 5 valvas romas  
Divaricatore completo con 5 valve smusse

24-711-00 (24-710-40 to 24-710-60)  
Retractor Complete with 5 Blades Sharp  
Separador completo con 5 valvas agudas  
Divaricatore completo con 5 valve acute

24-713-00 (24-711-40 to 24-711-60)  
Retractor Complete with 5 Blades Blunt  
Separador completo con 5 valvas romas  
Divaricatore completo con 5 valve smusse



Retractors, Cervical Spine  
Separadores, columna vertebral

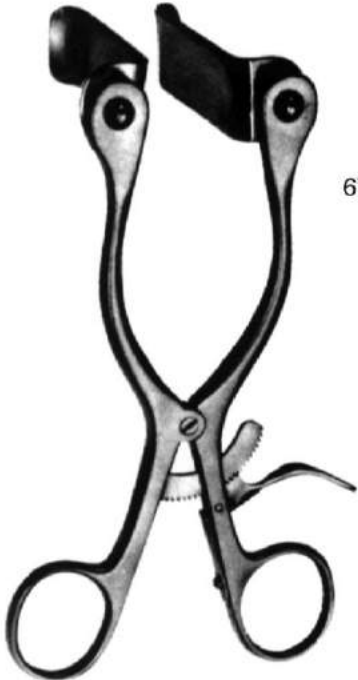

6"

**CASPAR**  
24-720-00 Complete with 5 Blades, 5 valvas, 5 valve)  
24-720-15 Without Blades, sin valvas, senza valve



6.75"

**CASPAR**  
24-721-00 Complete with 5 Blades, 5 valvas, 5 valve)  
24-721-15 Without Blades, sin valvas, senza valve



Blunt  
roma  
smussa

**CASPAR**  
24-724-00 Complete with 5 Blades, 5 valvas, 5 valve)  
24-724-11 Without Blades, sin valvas, senza valve

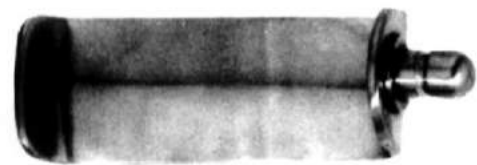

**CASPAR**  
24-720-45 45 x 20 mm  
24-720-50 50 x 20 mm  
24-720-55 55 x 20 mm  
24-720-60 60 x 20 mm  
24-720-65 65 x 20 mm



Deep

**CASPAR**  
24-724-40 40 x 20 mm  
24-724-45 45 x 20 mm  
24-724-50 50 x 20 mm  
24-724-55 55 x 20 mm  
24-724-60 60 x 20 mm



Shallow

**CASPAR**  
24-725-40 40 x 20 mm  
24-725-45 45 x 20 mm  
24-725-50 50 x 20 mm  
24-725-55 55 x 20 mm  
24-725-60 60 x 20 mm

Retractors  
Separadores



CASPAR  
24-744-00 Complete with 7 Blades, valvas, valva  
24-744-17 Without Blades, sin valvas, senza valve

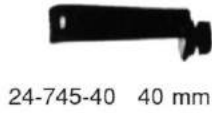

24-745-40 40 mm

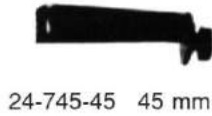

24-745-45 45 mm

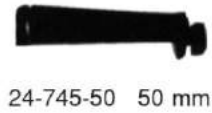

24-745-50 50 mm



24-745-55 55 mm



24-745-60 60 mm



24-745-65 65 mm



24-745-70 70 mm



24-747-45 45 mm

24-747-50 50 mm

24-747-55 55 mm

24-747-60 60 mm

24-747-65 65 mm



CASPAR  
24-747-45 to 24-747-65

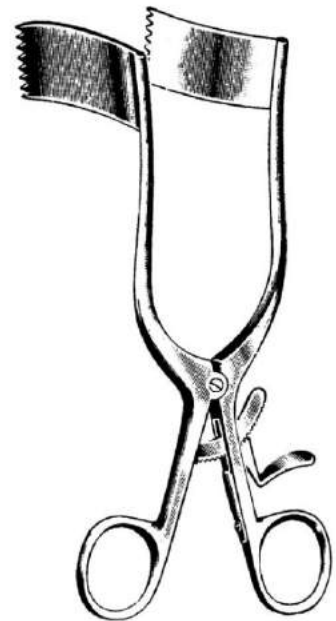

MEYERDING  
17 cm, 6 3/4"  
24-748-01 2.5 x 3.2 cm  
24-748-02 2.5 x 5.4 cm  
24-748-03 1.9 x 6.0 cm  
24-748-04 2.5 x 6.0 cm

Abdominal Retractors  
Separadores abdominales

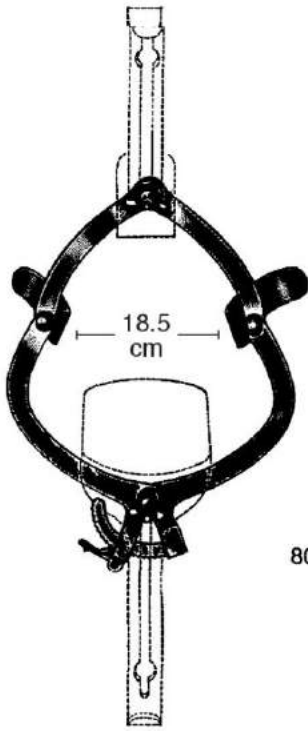

O'SULLIVAN - O'CONNOR  
24-754-00  
Complete

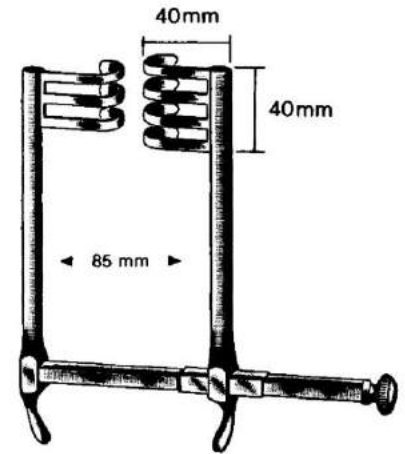
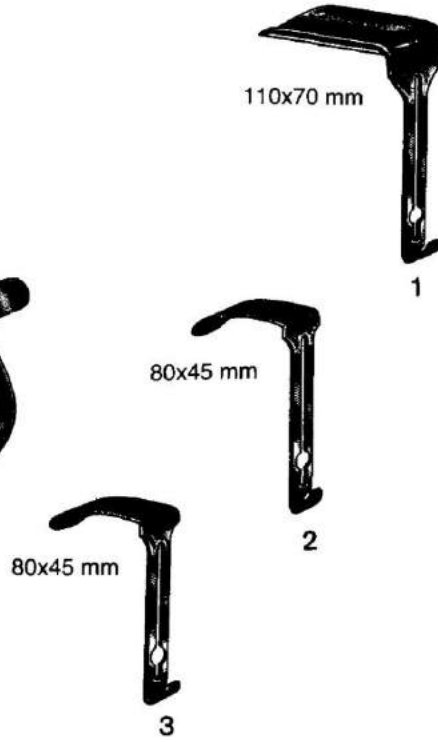

FRAZIER  
24-758-85

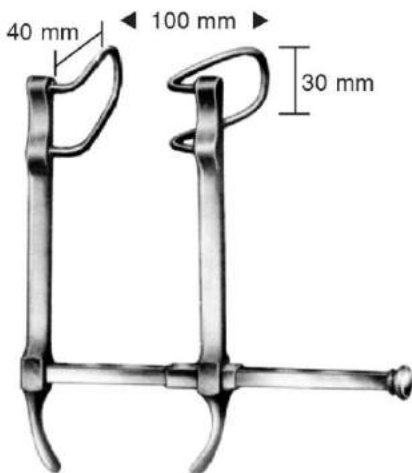

BABY - GOSSET  
24-759-00

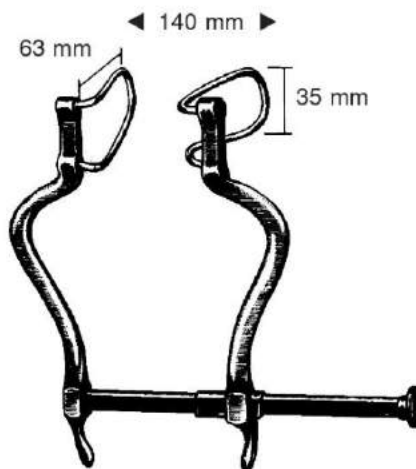

GOSSET  
24-760-14

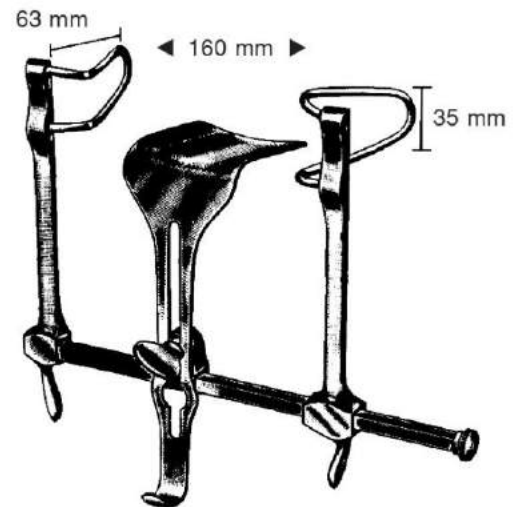

GOSSET  
24-762-16 160 mm



Abdominal Retractors  
Separadores abdominales

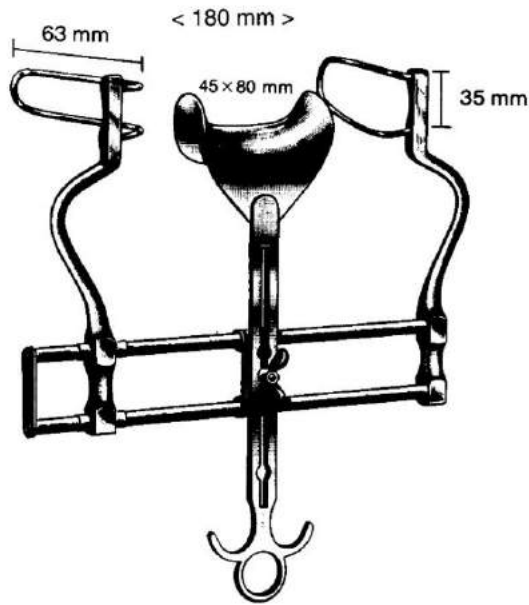

BALFOUR  
24-764-18  
18 cm, 7"

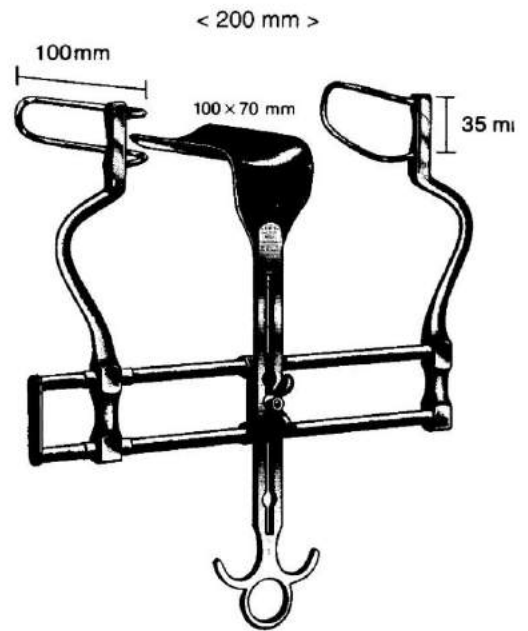

BALFOUR  
24-764-20  
20 cm, 8"

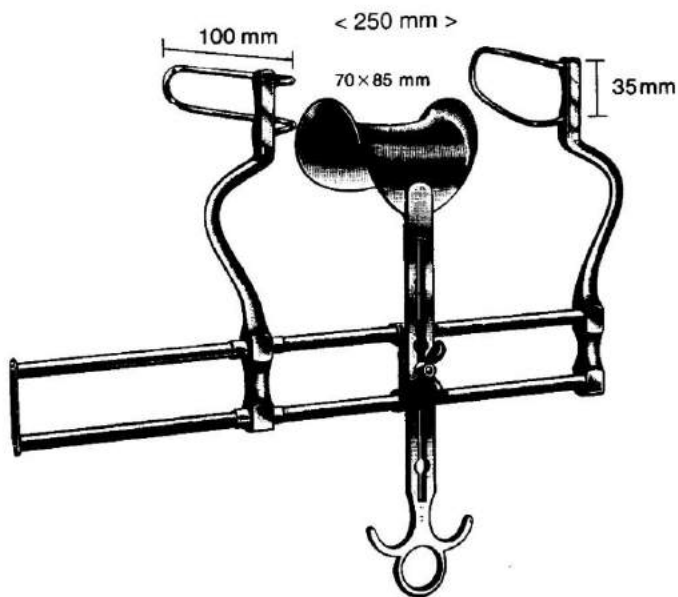

BALFOUR  
24-764-25  
25 cm, 10"

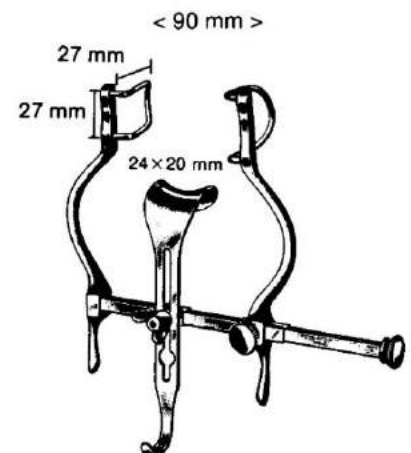

BABY-BALFOUR  
24-766-90  
9 cm, 3 1/2"



Abdominal Retractors  
Separadores abdominales

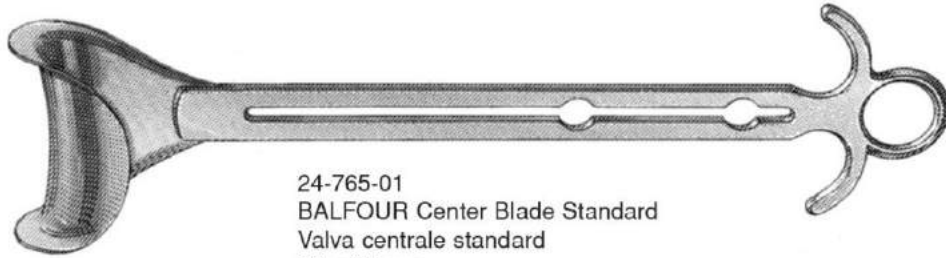

24-765-01  
BALFOUR Center Blade Standard  
Valva centrale standard  
80 x 45 mm

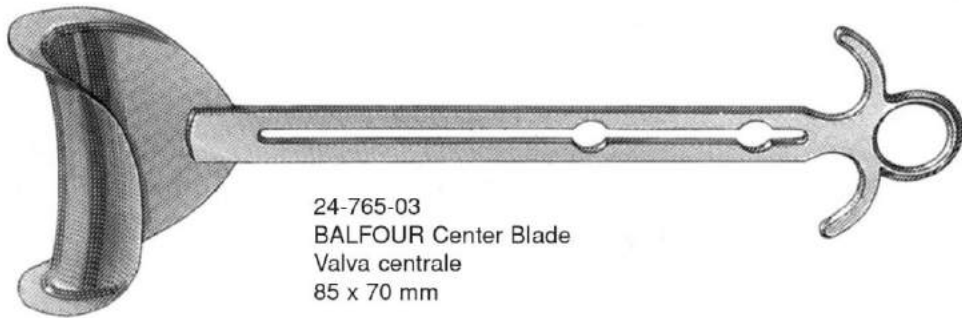

24-765-03  
BALFOUR Center Blade  
Valva centrale  
85 x 70 mm



24-765-04  
HORGAN, malleable  
Valva centrale malleabile  
51 x 126 mm

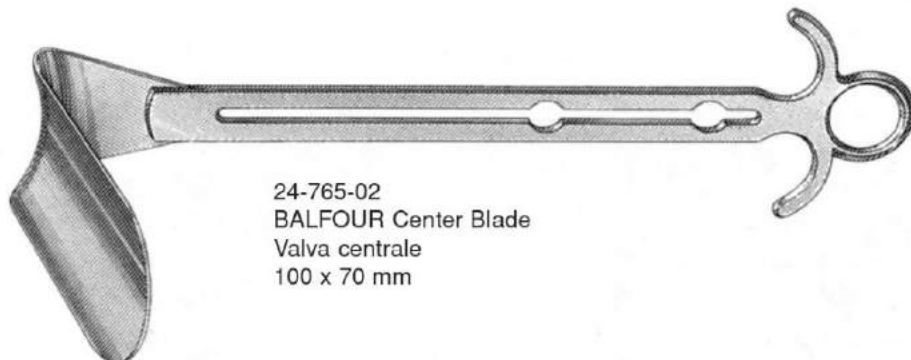

24-765-02  
BALFOUR Center Blade  
Valva centrale  
100 x 70 mm



## Abdominal Retractors Separadores abdominales



24-767-01  
Fenestrated Blades 6 cm, 2.4" Deep  
Valvas de alambre 6 cm, 2.4" profundidad  
Valve di filo profondità 6 cm, 2.4"



24-767-02  
Fenestrated Blades 8 cm, 3 1/8" Deep  
Valvas de alambre 8 cm, 3 1/8" profundidad  
Valve di filo profondità 8 cm, 3 1/8"



BALFOUR-US  
24-767-18  
Complete  
completo





## Abdominal Retractors Separadores abdominales

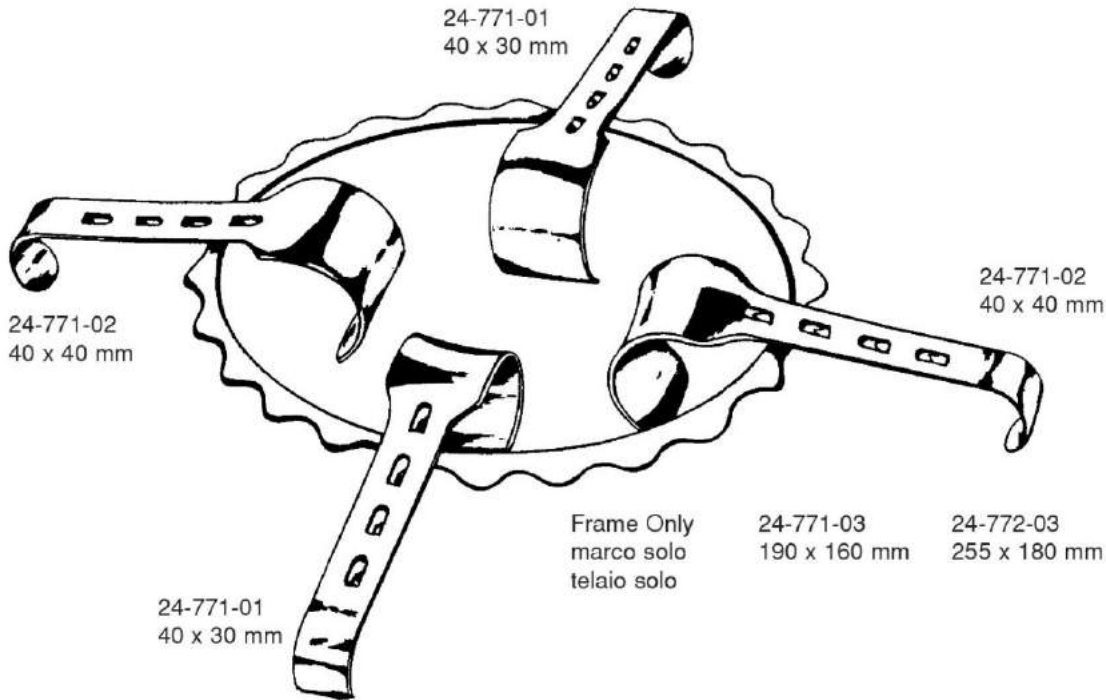

### DENIS-BROWNE

24-771-00 Complete Pediatric 190 x 160 mm  
 24-772-00 Complete Adult 255 x 190 mm

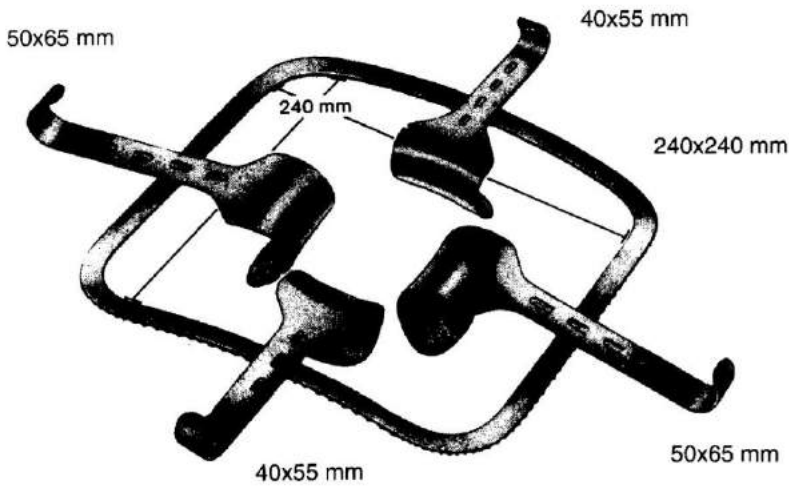

### KIRSCHNER



24-781-55 (Pair)  
40 x 55 mm



24-781-65 (Pair)  
50 x 65 mm

24-782-00 KIRSCHNER Abdominal Retractor Complete:  
 Kirschner separador abdominal, completo compuesto de:  
 Kirschner Divaricatore addominale completo, composto da:

24-781-55 2 Retractors / 2 separadores / 2 divaricatori 40 x 55 mm  
 24-781-65 2 Retractors / 2 separadores / 2 divaricatori 50 x 65 mm  
 24-783-24 Rigid Frame / marco rigido / telaio rigido 240 x 240 mm

## Abdominal Retractors Separadores abdominales



ROCHARD  
Complete



ROCHARD Frame Only  
24-780-01

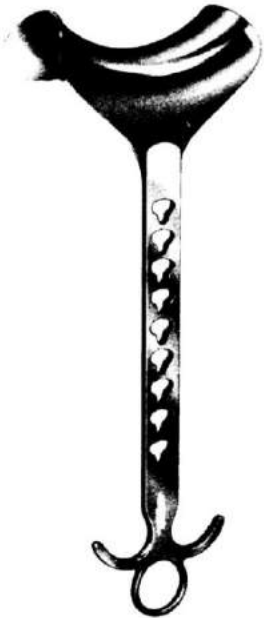

ROCHARD  
31 cm, 12 1/4"  
24-770-01 48 x 90 mm  
24-770-02 48 x 105 mm  
24-770-03 48 x 120 mm  
24-770-04 48 x 135 mm  
24-770-05 48 x 155 mm

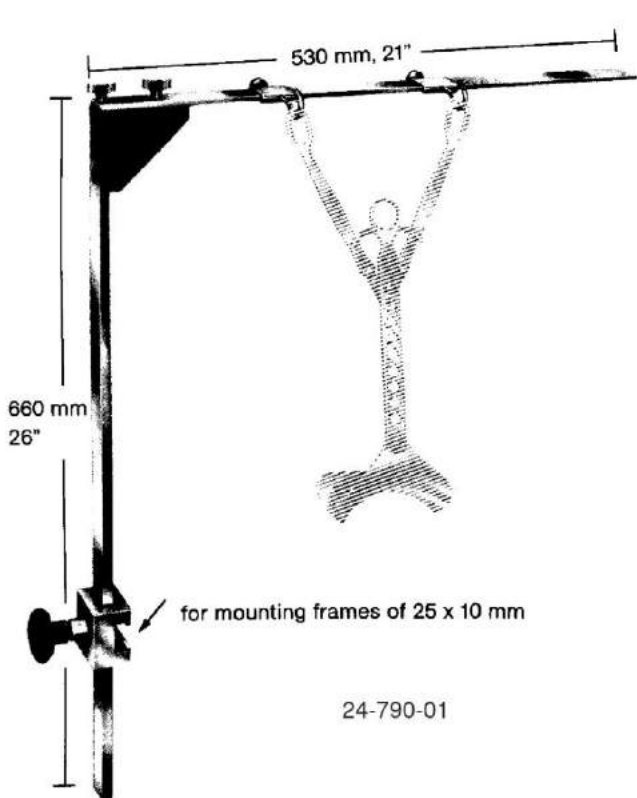

24-790-01

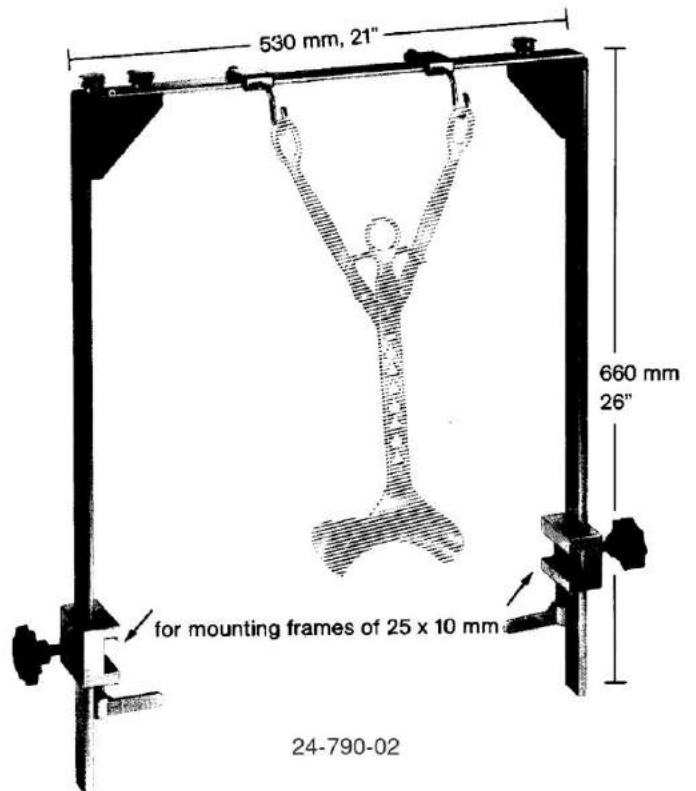

24-790-02



## Abdominal Retractors Separadores abdominales

KIRSCHNER  
24-784-00  
Complete  
completo

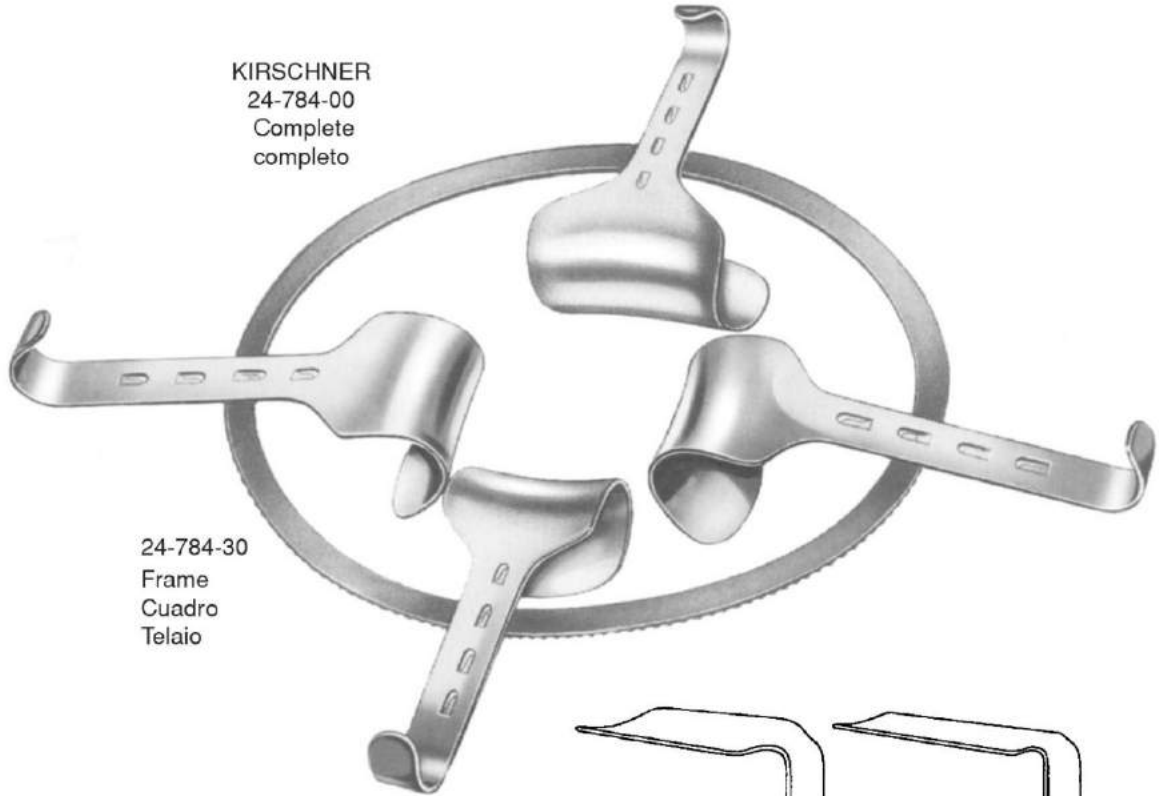

24-784-30  
Frame  
Cuadro  
Telaio

For Intestine and Bladder  
para intestino y vejiga  
per intestino e vescica

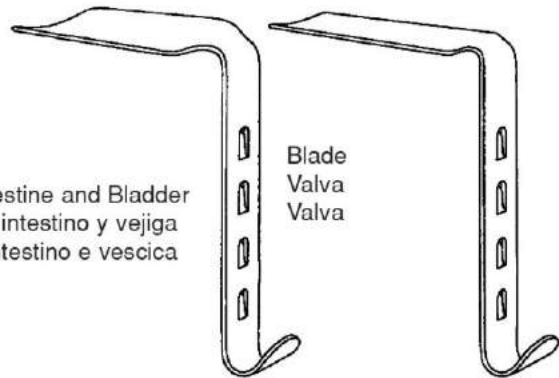

24-784-98  
98 x 50 mm

24-784-99  
105 x 35 mm

For Obese Patients  
para pacientes obesos  
per pazienti obesi

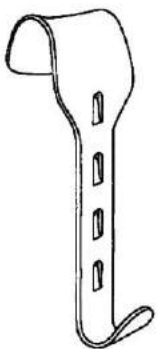

24-784-40  
40 x 55 mm

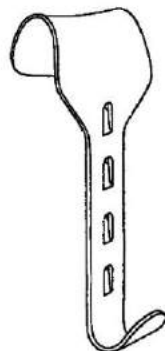

24-784-50  
50 x 65 mm

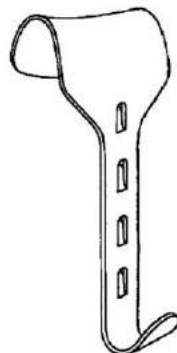

24-784-60  
60 x 85 mm

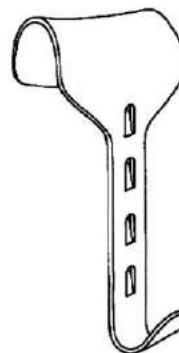

24-784-78  
78 x 65 mm

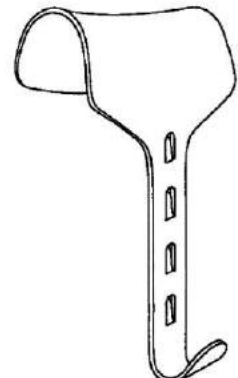

24-784-80  
80 x 90 mm

Endoscopic Arm System  
Sistema de brazo



24-795-01  
Arm System, radius 310/420 mm, including retractor and U-stand Ø 16 mm, 400 mm high, 400 mm wide, 170 mm deep.



24-795-02  
Arm System, radius 310/420 mm, including stand, clamp, endoscope holder Ø 8/10 mm.



24-798-01  
Single Tube Holder



24-798-02  
Endoscope Holder Universal  
Ø 3-10 mm



24-798-03  
Universal Retractor Holder



24-798-04  
Extended Articulation  
180 mm long, lockable



**24-799-01**  
 Clamp socket made of stainless steel, for height-adjustable stand  $\varnothing$  16 mm, electrically insulated up to 1.5 kV AC, holding width of 35 mm for rails 25/32 x 8/12 mm.



**24-799-02**  
 Clamp socket made of stainless steel, for height-adjustable stand  $\varnothing$  16 mm, electrically insulated up to 1.5 kV AC, holding width of 35 mm for rails 25/32 x 8/12 mm.



**24-799-03**  
 Clamp socket made of light metal, holding width 35 mm, for screw stand  $\varnothing$  16 mm/M10, for rails 25/35 x 8/10 and tubes  $\varnothing$  12 - 35 mm.



**24-799-04**  
 Clamp socket made of light metal, holding width 50 mm, for height-adjustable stand  $\varnothing$  16 mm, for rails 25/35 x 8/10 and tubes  $\varnothing$  12 - 35 mm.



**24-799-05**  
 Clamp socket made of stainless steel, for height-adjustable stand  $\varnothing$  16 mm, electrically insulated up to 4.5 kV AC, holding width of 50 mm for rails 25/32 x 8/12 mm.



**24-799-06**  
 Clamp socket made of light metal, holding width 50 mm, for screw stand  $\varnothing$  16 mm/M10, for rails 25/35 x 8/10 and tubes  $\varnothing$  12 - 35 mm.



## Abdominal Retractors Separadores abdominales



DOYEN

28 cm, 11"

- 24-800-01 48 x 90 mm
- 24-800-02 48 x 105 mm
- 24-800-03 48 x 120 mm
- 24-800-04 48 x 135 mm

< 100 mm >

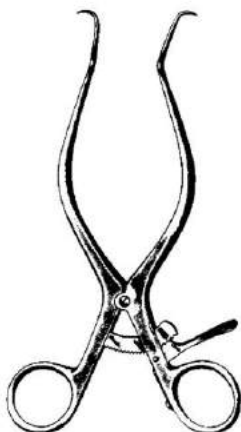

GELPI

- 24-802-09 9 cm, 3 1/2"
- 24-802-11 11 cm, 4 3/8"
- 24-802-14 14 cm, 5 1/2"
- 24-802-16 16 cm, 6 1/4"
- 24-802-18 18 cm, 7"

< 100 mm >



GELPI

- 24-804-18
- 18 cm, 7"

< 100 mm >

60 mm

20 mm



RIGBY

- 24-806-18
- 18 cm, 7"

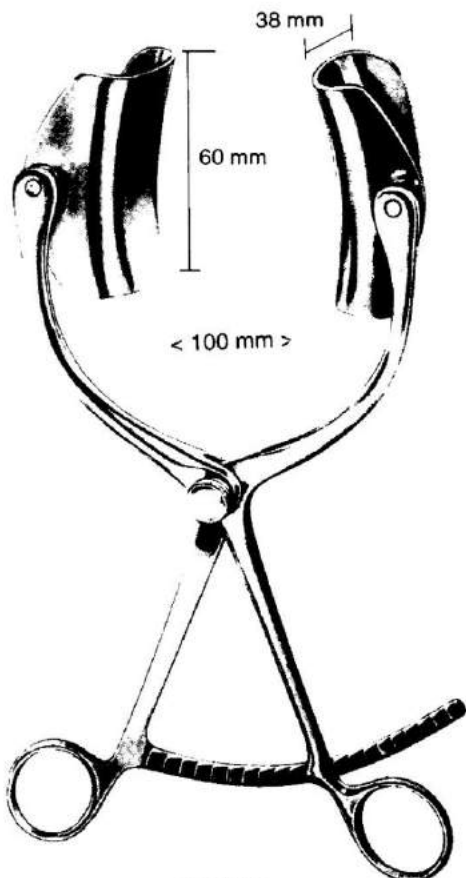

COLLIN  
24-810-22

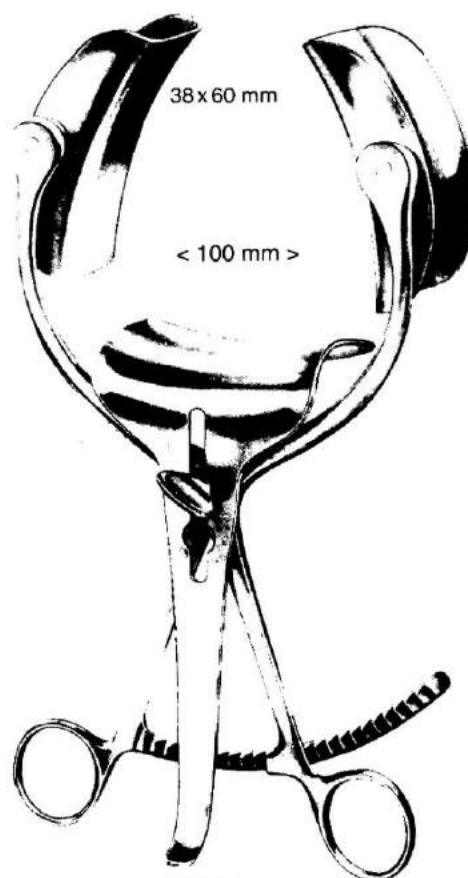

COLLIN  
24-812-60



Abdominal Retractors  
Separadores abdominales

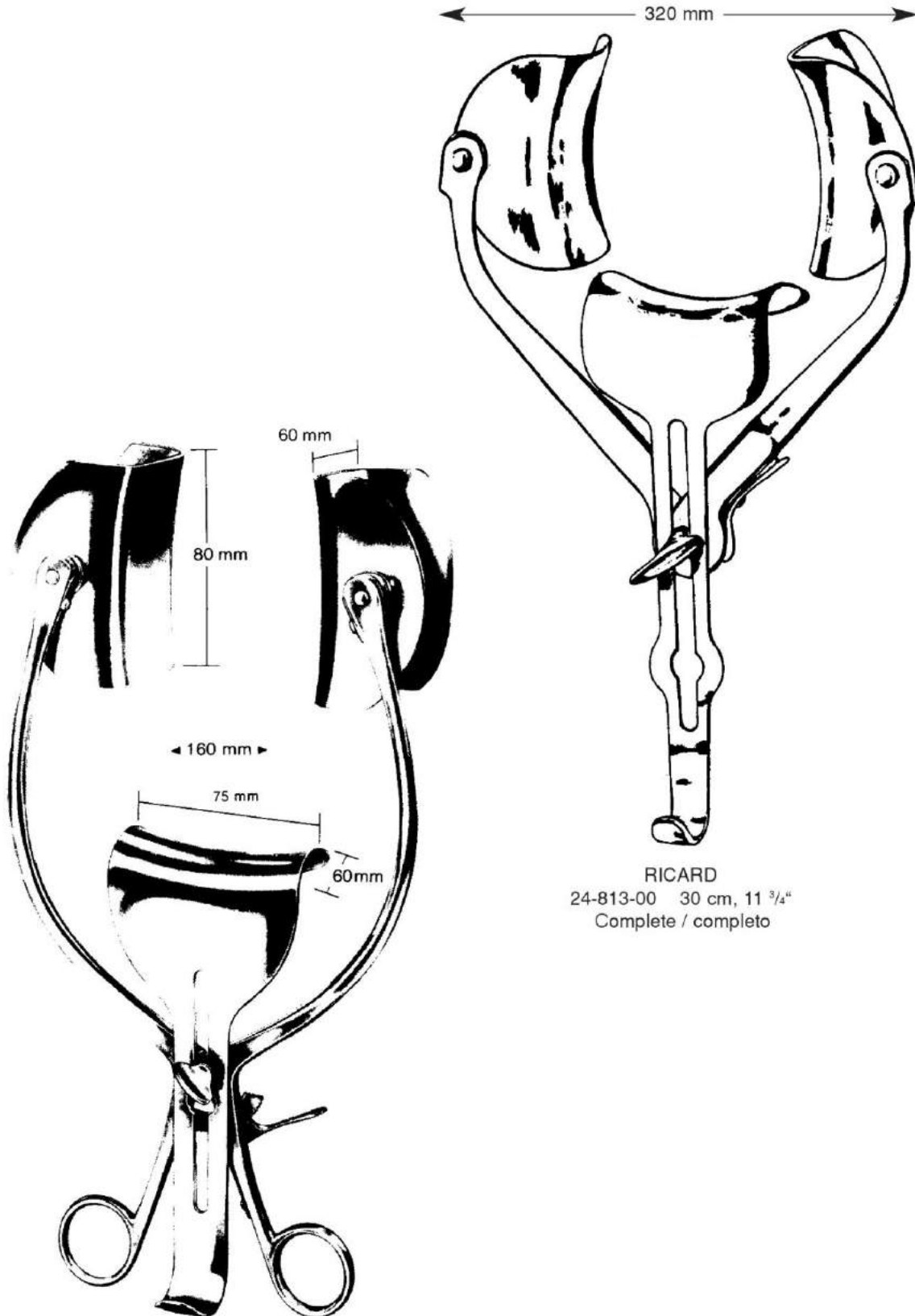

COLLIN Loktite  
24-816-00

RICARD  
24-813-00 30 cm, 11 <sup>3</sup>/<sub>4</sub>"  
Complete / completo

Back Holder Abdominal Retractor & Accessories (Through Page 195)  
Operation Table Set

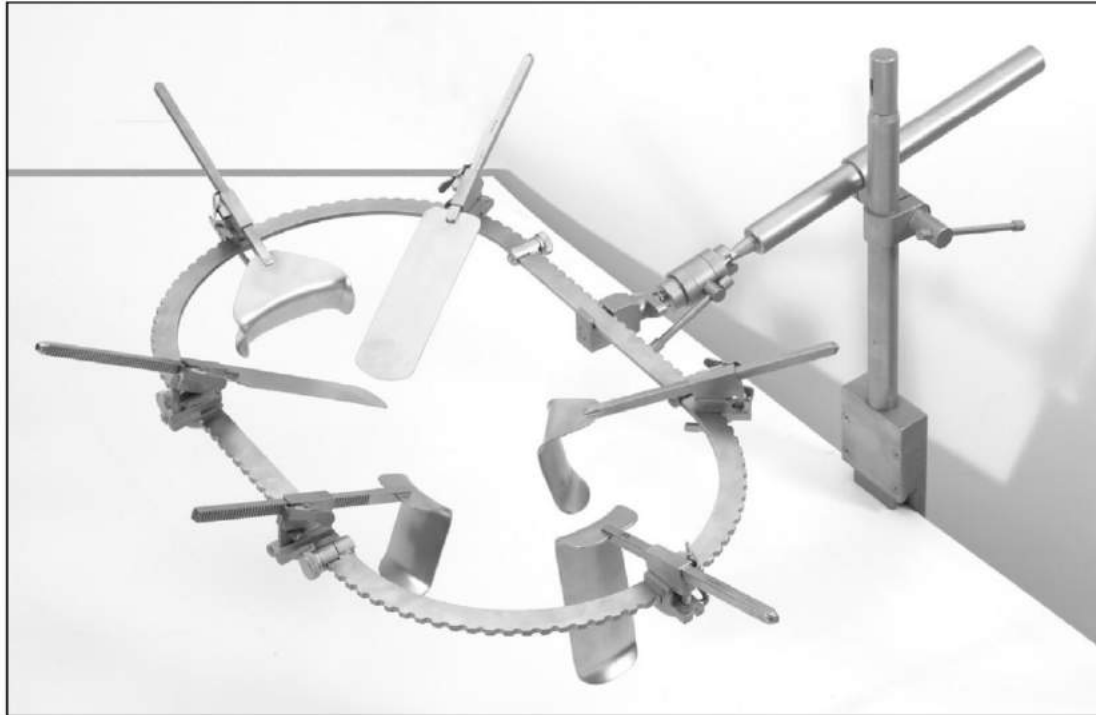

**Complete Fixed Abdominal Retractor Set**  
24-820-99

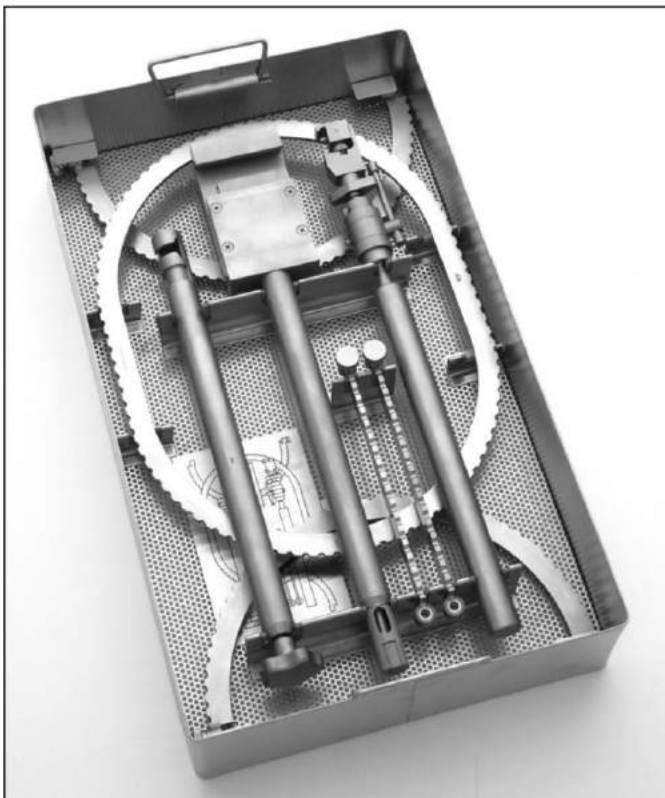

The many components of the **Back Holder Abdominal Retractor Operation Table Set** can be neatly arranged into autoclave sized containers with diagrams that direct instrument handlers on the proper placement of each component.

*A major convenience in care and maintenance of the Retractor Set.*

**Sterilization Container & Baskets**

Description	Product No
Table Fixation & Ring Container	24-820-90
Blade & Accessories Container	24-820-91



**Back Holder Abdominal Retractor  
Operation Table Set**

<b>Description</b>	<b>Product No</b>	<i>Composto da</i>	
Complete Abdominal Retractor Set	24-820-99	Accoppiatore	24-821-01
		Barra orizzontale	24-821-02
<i>Includes</i>		Morsetto di accoppiamento	24-821-04
Table Post	24-821-01	Anello ovale	24-820-02
Horizontal Bar	24-821-02	No. 2 retrattori malleabili, 51x152 mm	24-825-06
1" Post Coupling	24-821-04	No. 2 Valve Kelly, dim. 51x76 mm	24-822-23
Oval Ring	24-820-02	Valva Kelly	24-822-24
2" X 6" Malleable Retractor (2 ea)	24-825-06	Valva Balfour	24-823-33
2" X 3" Kelly Retractor (2 ea)	24-822-23	Morsetto trasportabile con trasporto ad intervallo progressivo di 2 mm	24-820-10
2" X 4" Kelly Retractor	24-822-24	Morsetto articolato multidisciplinare con funzione movimento assiale orizzontale e verticale	24-820-20
Balfour Retractor	24-833-33	Anello rotondo circolare, dimensione 226 mm	24-820-01
Ratchet Mechanism (2 ea)	24-820-10	Anello ovale 266x367 mm	24-820-02
Tilt Ratchet Mechanism (6 ea)	24-820-20	Anello a segmento 266x495 mm	24-820-03
Segmented Ring	24-820-03	Retratore malleabile 38x152 mm	24-824-06
1 1/2" X 6" Malleable Retractor	24-824-06	Retratore malleabile 76x152 mm	24-826-06
3" x 6" Malleable Retractor	24-826-06	Valva Kelly, 51x127 mm	24-822-25
2" X 5" Kelly Retractor	24-822-25	Valva Kelly, 51x152 mm	24-822-26
2" X 6" Kelly Retractor	24-822-26	Barra flessibile orizzontale	24-821-03
Horizontal Flex Bar	24-821-03	Retratore Harrington 63x143 mm	24-831-25
Harrington Retractor	24-831-25	Retratore con punta Gelpi	24-834-01
Gelpi Retractor	24-834-01		
<i>Accessories</i>		<i>Accessori:</i>	
Table Fixation & Ring Case	24-820-90	<i>Container vuoto in acciaio inox dotato con griglia interna</i>	
Blades & Accessories Case	24-820-91	Descrizione	
		Container in acciaio inox dotato di griglia interna per Accessori di fissazione, anelli e barre	24-820-90
		Container in acciaio inox dotato di griglia interna per morsetti e divaricatori	24-820-91



## Accessories

### Malleable Retractors with Protective Edge

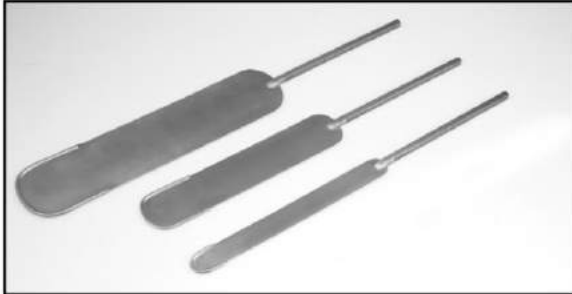

Description	Product No
1½" x 6" 38 x 152 mm	24-824-06
2" x 6" 51 x 152 mm	24-825-06
3" x 6" 76 x 152 mm	24-826-06

### Specialty Retractors

Description	Product No
Balfour Retractor 2⅝" x 3" 67 x 76 mm	24-833-33
Gelpi Point Retractor	24-834-01



### Harrington Retractors

Description	Product No
Blade 2.5" x 5⅝" 63 x 143 mm	24-831-25

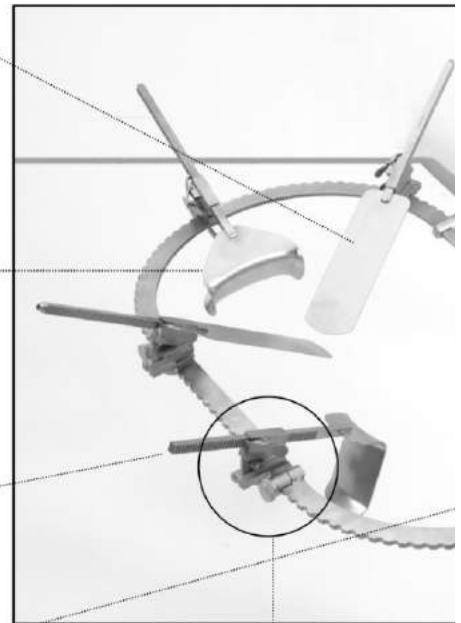

Description	Product No
Blade 2" x 1½"	51 x 38 mm 24-822-21
Blade 2" x 2"	51 x 51 mm 24-822-22
Blade 2" x 2½"	51 x 64 mm 24-822-22L
Blade 2" x 3"	51 x 76 mm 24-822-23
Blade 2" x 4"	51 x 102 mm 24-822-24
Blade 2" x 5"	51 x 127 mm 24-822-25
Blade 2" x 6"	51 x 152 mm 24-822-26



Description	Product No
Blade 1" x 1½" 25 x 38 mm	24-822-01
Blade 1" x 2½" 25 x 63 mm	24-822-02

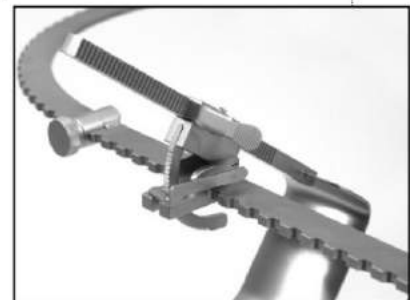

**Tilt Ratchet Mechanism** allows extensions or retractions along the horizontal axis and allows vertical movement of retractor blade with a second ratchet

**Product No** 24-820-20

**Table Mounting Components**

Description	Product No
1" Post Coupler	24-821-04

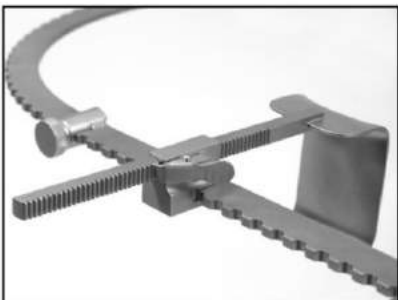
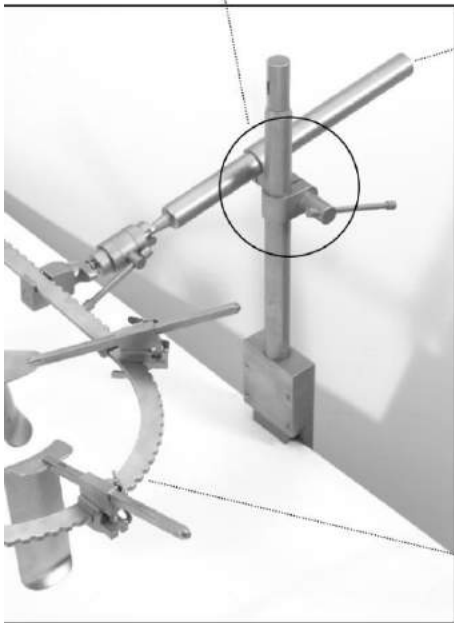

**Fixed Ratchet Mechanism** allows extension or retraction along the horizontal axis at 2mm intervals

**Product No** 24-820-10

**Table Mounting Components**

Table Post	24-821-01
Horizontal Bar	24-821-02
Horizontal Flex Bar	24-821-03

**Retractor Rings**

Description	Product No
Round Ring 10.5 inch / 266 mm	24-820-01
Oval Ring 10.5 x 14.5 inch / 266 x 367 mm	24-820-02
Segmented Ring 10.5 x 19.5 inch / 266 x 495 mm (Consists of one 10.5 inch Round Ring and two 8 inch straight segments)	24-820-03

## Laminectomy Retractors Separadores para laminectomia



24-910-00  
SCOVILLE-HAVERFIELD  
Frame only  
Marco solo  
Telaio solo



24-911-00  
SCOVILLE  
Frame only  
Marco solo  
Telaio solo



SCOVILLE  
50 mm, 2"  
24-912-50



SCOVILLE  
70 mm, 2 3/4"  
24-912-70



SCOVILLE  
24-914-41 41 x 38 mm  
24-914-67 67 x 44 mm



TAYLOR  
24-915-48 48 x 50 mm  
24-915-64 64 x 50 mm  
24-916-64 64 x 64 mm  
24-916-80 80 x 57 mm



SCOVILLE  
50 mm, 2"  
24-913-50



SCOVILLE  
70 mm, 2 3/4"  
24-913-70



SCOVILLE  
24-917-64 64 x 25 mm  
24-918-64 64 x 50 mm  
24-918-88 88 x 25 mm



## Retractors for Plastic Surgery Separadores para cirugía plástica



With Cold Light & Aspiration  
con luz fría & aspiración  
con luce fredda & aspirazione

### TEBBETTS

24-980-01	80 mm x 16 mm
24-980-02	100 mm x 25 mm
24-980-03	120 mm x 25 mm
24-980-04	120 mm x 30 mm
24-980-05	150 mm x 25 mm
24-980-06	150 mm x 30 mm



### FERRIERA

24-960-01	80 mm x 16 mm
24-960-02	100 mm x 25 mm
24-960-03	120 mm x 25 mm
24-960-04	120 mm x 30 mm
24-960-05	150 mm x 25 mm
24-960-06	150 mm x 30 mm



Retractors for Plastic Surgery  
Separadores para cirugía plástica



24-970-01  
37 x 70 mm  
22 x 54 mm

BREAST RETRACTOR  
31 cm, 12 1/4"



CORONAL BROW LIFT  
24-980-18  
18 cm, 7"



YANCOSKIE  
24-990-18  
18 cm, 7"

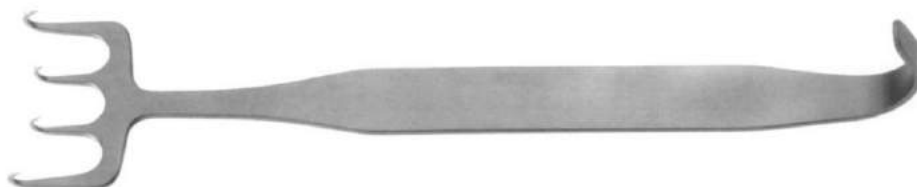

FREEMAN  
24-995-38 18 cm 1 1/2" Wide  
24-995-22 18 cm 7/8" Wide



ANDERSON  
24-998-03 12 cm 3 Prong  
3 rebbi  
24-998-05 12 cm 5 Prong  
5 rebbi



Probes, Directors  
Sondas, estiletes



2 mm ø

- 11.5 cm, 4 1/2" 26-102-11
- 13.0 cm, 5 1/8" 26-102-13
- 14.5 cm, 5 3/4" 26-102-14
- 16.0 cm, 6 1/4" 26-102-16
- 18.0 cm, 7" 26-102-18
- 20.0 cm, 8" 26-102-20
- 25.0 cm, 10" 26-102-25



1 mm ø

- 26-104-11
- 26-104-13
- 26-104-14
- 26-104-16
- 26-104-18
- 26-104-20
- 26-104-25



2 mm ø

- 26-106-11
- 26-106-13
- 26-106-14
- 26-106-16
- 26-106-18
- 26-106-20
- 26-106-25



26-108-14  
14.5 cm, 5 3/4"



**BRODIE**  
26-109-18  
18 cm  
7"



- 13.0 cm, 5 1/8" 26-110-13
- 14.5 cm, 5 3/4" 26-110-14
- 16.0 cm, 6 1/4" 26-110-16
- 18.0 cm, 7" 26-110-18
- 20.0 cm, 8" 26-110-20



**DOYEN**  
26-111-14  
14 cm  
5 1/2"



26-112-14  
14.5 cm  
5 3/4"



**STACKE**  
26-115-10  
10.5 cm  
4.25"



**NELATON**  
26-120-16  
16 cm  
6 1/4"



**FISH**  
26-121-14  
14 cm, 5 1/2"  
26-121-18  
18 cm, 7"



**WATSON-CHEYNE**  
26-122-13  
13 cm, 5 1/8"  
26-122-18  
18 cm, 7"



Fistula Probes  
Sondas para fistula



LOCKHART-MUMMERY  
26-125-01  
16.5 cm, 6 1/2"

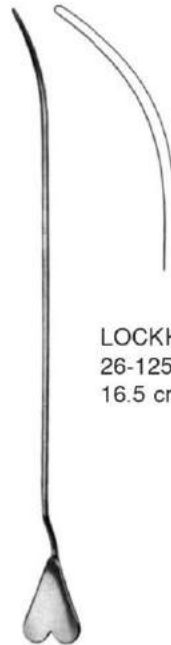

LOCKHART-MUMMERY  
26-125-02  
16.5 cm, 6 1/2"

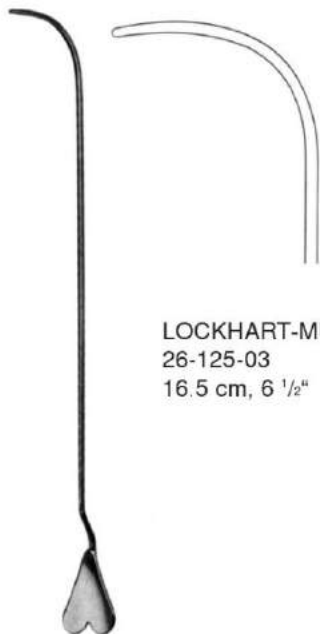

LOCKHART-MUMMERY  
26-125-03  
16.5 cm, 6 1/2"



LOCKHART-MUMMERY  
26-125-04  
16.5 cm, 6 1/2"





## Varicose Vein Probe Set in Metal Case Juego para várices en estuche de metal

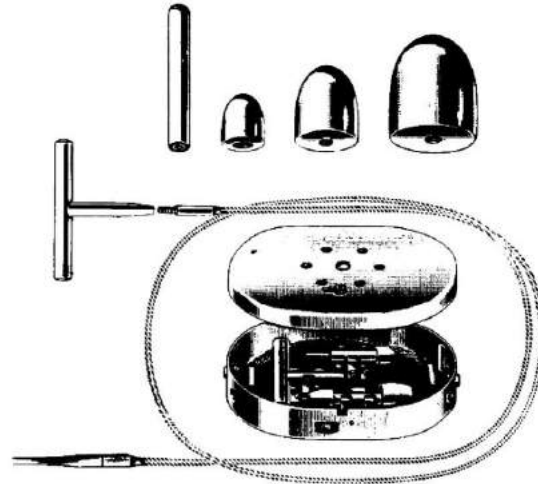

NABATOFF Set  
26-150-00  
135 x100 x 25 mm  
Complete

## Spare Parts Piezas de repuesto Pezzi di ricambio

26-150-02



26-150-90

Flexible Cable  
cable de traccion flex.  
Corda di trazione fless.

26-150-80



Handle Only  
Mango suelto  
Manico solo



26-150-03  
3 mm  $\varnothing$



26-150-06  
6 mm  $\varnothing$



26-150-09  
9 mm  $\varnothing$



26-150-12  
12 mm  $\varnothing$



26-150-15  
15 mm  $\varnothing$

Probe Tips  
Puntas sueltas  
Punte



Varix Instruments  
Instrumentos para varices



VARADY  
26-154-01  
180 mm, 7"



VARADY  
26-154-02  
180 mm, 7"



VARADY  
26-154-03  
180 mm, 7"



VARADY  
26-154-04  
175 mm, 6.9"



VARADY  
26-154-05  
170 mm, 6 3/4"



VARADY  
26-154-06  
170 mm, 6 3/4"

26-162-12  
12 cm, 4 3/4"  
Handle  
Mango  
Manico



26-160-04  
to  
26-160-14



26-160-04  
4 mm ø



26-160-06  
6 mm ø



26-160-07  
7 mm ø



26-160-08  
8 mm ø

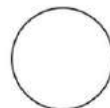

26-160-10  
10 mm ø

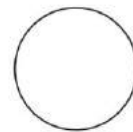

26-160-12  
12 mm ø

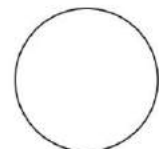

26-160-14  
14 mm ø



Spatulas, Cotton Applicators  
Espátulas, porta-algodones



**FARRELL**

- 26-270-12 12.0 cm
- 26-270-14 14.0 cm
- 26-270-16 16.5 cm
- 26-270-18 18.0 cm
- 26-270-23 23.0 cm



**FARRELL**

- 26-272-12 12.0 cm
- 26-272-14 14.0 cm
- 26-272-16 16.5 cm
- 26-272-18 18.0 cm
- 26-272-23 23.0 cm



1,5



1,5

**BOOTNAS**

- |                 |                 |
|-----------------|-----------------|
| 26-290-12 12 cm | 26-292-12 12 cm |
| 26-290-14 14 cm | 26-292-14 14 cm |
| 26-290-16 16 cm | 26-292-16 16 cm |
| 26-290-18 18 cm | 26-292-18 18 cm |

Plaster Spatula  
Espátula  
Spatole



26-190-14  
14.5 cm, 5 3/4"



**UCKERMANN**  
26-310-15  
15 cm, 6"



**JOBSON-HORNE**  
26-320-12 12 cm, 4 3/4"  
26-320-18 18 cm, 7"

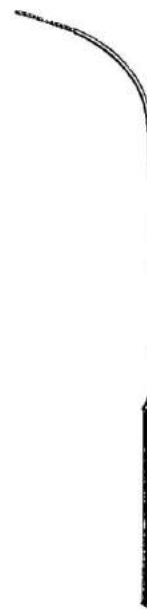

**TOBOLD**  
26-331-25  
25 cm, 10"

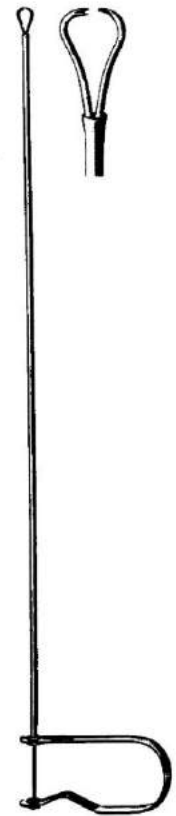

26-340-45  
45 cm, 17 3/4"

## Trocars Trócares

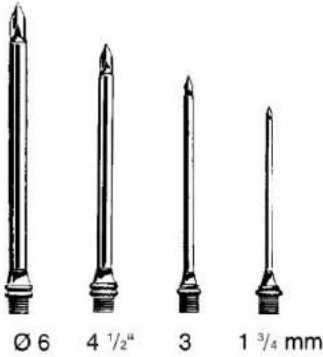

UNIVERSAL  
28-104-00  
Complete



STANDARD (Nelson)  
28-110-30    3.0 mm Ø  
28-110-35    3.5 mm Ø  
28-110-40    4.0 mm Ø  
28-110-45    4.5 mm Ø  
28-110-50    5.0 mm Ø  
28-110-55    5.5 mm Ø  
28-110-60    6.0 mm Ø



PIERCE  
28-123-30    3 mm Ø  
28-123-40    4 mm Ø  
28-123-50    5 mm Ø



DOUGLAS  
28-125-11    3 mm Ø



LICHTWITZ  
28-128-19    1.75 mm Ø

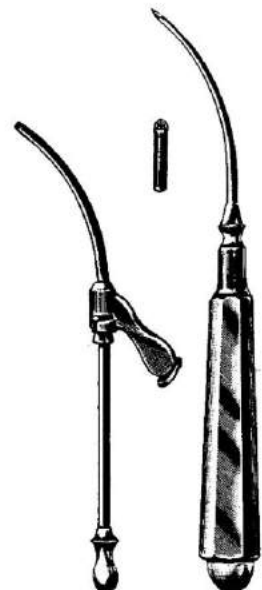

COAKLEY  
28-140-02    2.25 mm Ø



## Trocars Trócares



Charriere

Fr	OCHSNER
10	28-150-10
12	28-150-12
14	28-150-14
16	28-150-16
18	28-150-18
20	28-150-20



Charriere

Fr	NELSON
25	28-170-25
30	28-170-30
33	28-170-33
35	28-170-35



SINOSCOPY TROCAR  
Universal  
8.5 cm, 3.4"

28-180-27 for Optic  
with Ø 2.7 mm  
28-180-40 for Optic  
with Ø 4.0 mm



SINOSCOPY TROCAR  
Oblique  
8.5 cm, 3.4"

28-181-40 for Optic with Ø 4.0 mm

## Biopsy Needles Agujas para biopsia

Pudendal  
Anesthesie  
anestesia



IOWA  
28-210-00  
Complete

Pneumoperitoneum  
Neumoperitoneo  
Pneumoperitoneo



VERRES  
28-250-20 2 x 100 mm  
28-250-40 2 x 140 mm



QUINKE  
28-230-07 0.7x76 mm  
28-232-07 0.7x89 mm  
28-230-10 1.0x76 mm  
28-232-10 1.0x89 mm  
28-230-12 1.2x76 mm  
28-232-12 1.2x89 mm



MENGHINI  
28-302-01 1.0 x 35 mm  
28-302-02 1.0 x 70 mm  
28-302-03 1.2 x 70 mm  
28-302-04 1.2 x 100 mm  
28-302-05 1.4 x 70 mm  
28-302-06 1.4 x 100 mm  
28-302-07 1.6 x 70 mm  
28-302-08 1.8 x 100 mm



MENGHINI  
28-310-14 1.4 x 168 mm  
28-310-18 1.8 x 168 mm

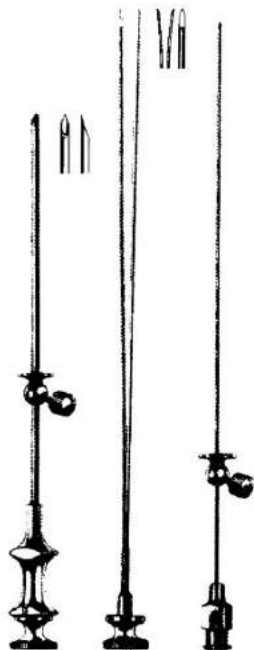

FRANKLIN-SILVERMAN  
28-330-20  
28-330-14  
Complete

	ø Ext. mm	ø Int. mm
28-330-20	2 x 105	1.5 x 155
28-330-14	2 x 130	1.5 x 180

Biopsy Needle  
Aguja para biopsia  
Ago per biopsia

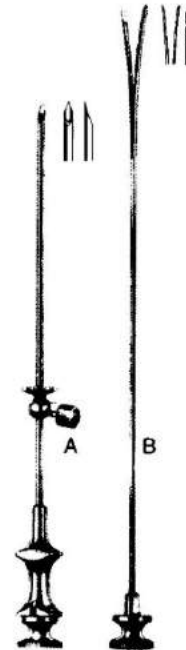

Bifurcated  
Aguja bifurcada  
Ago biforcato

FRANKLIN-SILVERMAN

	A	ø mm	B	ø mm	A+B	
28-351-20	2.0	x 100	28-352-15	1.5	x 150	28-350-20
28-351-30	2.5	x 145	28-352-20	2.0	x 195	28-350-30
28-353-20	2.0	x 100	28-356-15	1.5	x 150	28-354-20
28-353-25	2.5	x 145	28-356-20	2.0	x 195	28-354-25

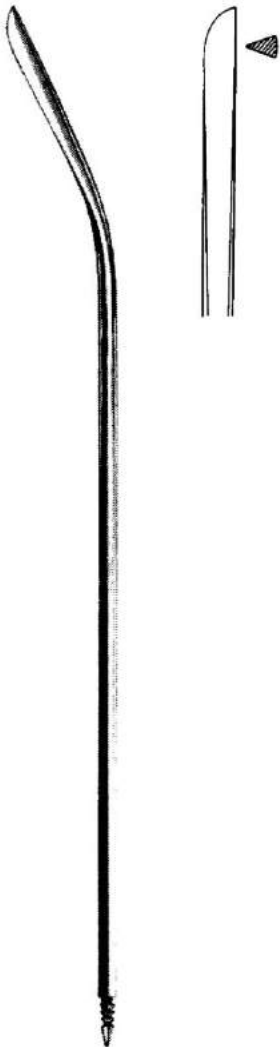

28-195-08 to 28-195-18

Guide Needle, Straight  
Aguja de Guía, recta  
Ago guida, retta

Charr./Fr.

8 28-195-08  
10 28-195-10  
12 28-195-12  
14 28-195-14  
16 28-195-16  
18 28-195-18

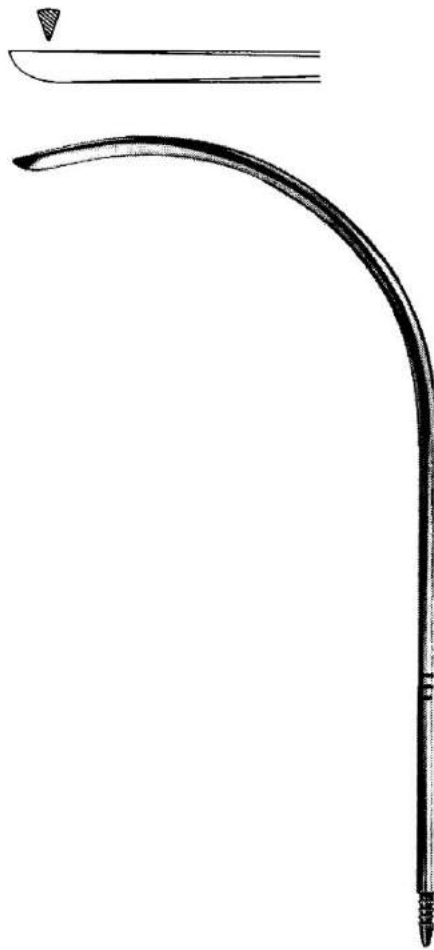

28-197-08 to 28-197-18

Guide Needle, Curved  
Aguja de Guía, curva  
Ago guida, curva

Charr./Fr.

8 28-197-08  
10 28-197-10  
12 28-197-12  
14 28-197-14  
16 28-197-16  
18 28-197-18

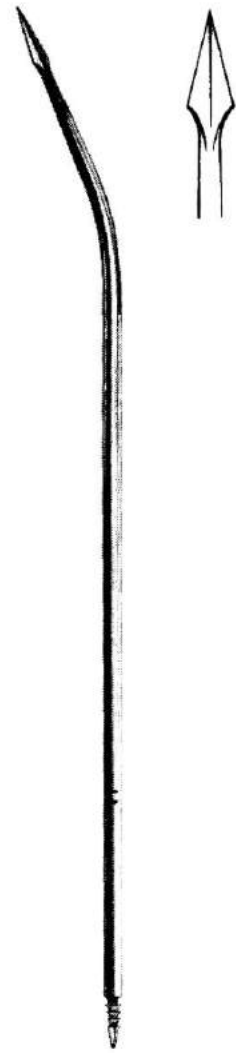

28-198-08 to 28-198-18

Guide Needle, with Lancet Tip  
Aguja de Guía, con punta lanceolar  
Ago guida, con punta lanceolata

Charr./Fr.

8 28-198-08  
10 28-198-10  
12 28-198-12  
14 28-198-14  
16 28-198-16  
18 28-198-18



## Needle Holders Porta-agujas



**DERF**  
30-110-12  
12 cm, 4 3/4"  
30-110-12 TC  
12 cm, 4 3/4"



**CONVERSE**  
30-120-12  
12 cm, 5"



**COLLIER**  
30-122-12  
12.5 cm, 5"

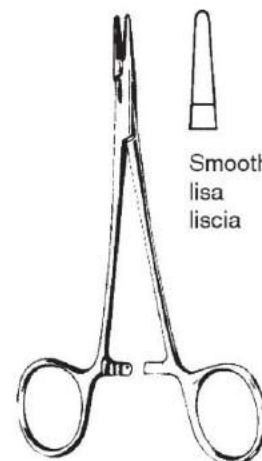

Smooth  
lisa  
liscia

**WEBSTER**  
30-128-13  
13 cm, 5 1/8"  
30-128-13 TC  
13 cm, 5 1/8"

**BABY-WEBSTER**  
30-136-11  
11 cm, 4 3/8"  
30-136-11 TC  
11 cm, 4 3/8"

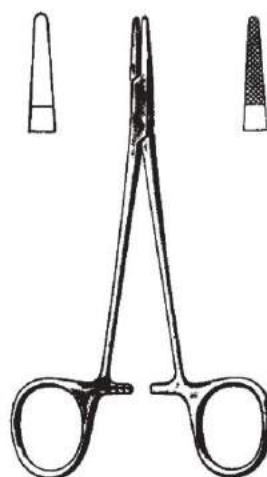

**HALSEY**  
30-130-13 30-140-13  
30-130-13 TC 30-140-13 TC  
13 cm, 5 1/8"

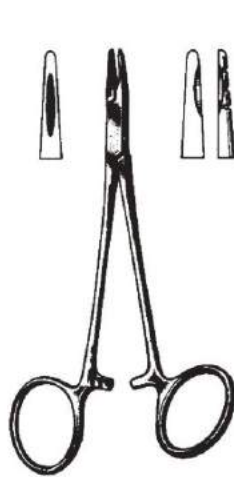

**NEIVERT**  
30-146-13  
13 cm, 5 1/8"

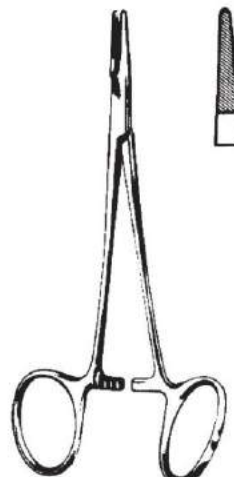

**NEIVERT**  
30-146-13 TC  
13 cm, 5 1/8"



**BAUMGARTNER**  
30-150-12 30-150-12 TC  
12.5 cm, 5"  
30-150-14 30-150-14 TC  
14 cm, 5 1/2"





Needle Holders  
Porta-agujas



CRILE-WOOD

- 30-160-15 6" 30-160-15 TC
- 30-160-18 7" 30-160-18 TC
- 30-160-20 8" 30-160-20 TC
- 30-160-23 9" 30-160-23 TC



CRILE-MURRAY

- 30-170-15 30-170-15 TC
- 15 cm, 6"

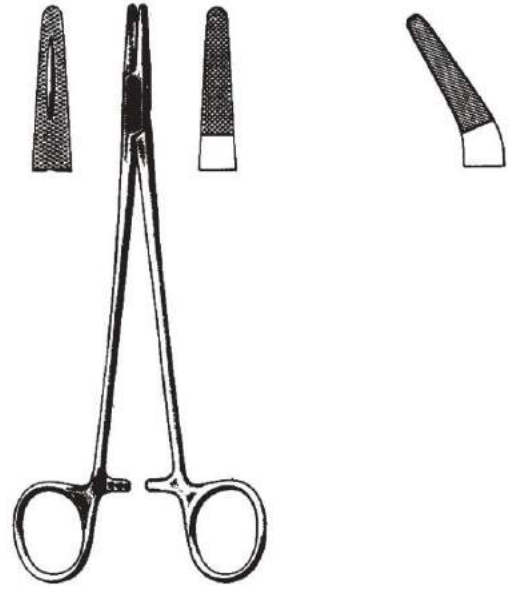

MAYO-HEGAR

- 30-180-12 4 3/4" 30-180-12 TC
- 30-180-13 5" 30-180-13 TC
- 30-180-15 6" 30-180-15 TC
- 30-180-18 7" 30-180-18 TC
- 30-180-20 8" 30-180-20 TC
- 30-180-24 9 1/2" 30-180-24 TC
- 30-180-26 10 1/4" 30-180-26 TC
- 30-180-30 11 3/4" 30-180-30 TC
- 30-185-18 TC 18 cm
- 30-185-20 TC 20 cm
- 30-185-24 TC 24 cm
- 30-185-26 TC 26 cm



fine  
delicate  
fino

MAYO-HEGAR

- 30-190-16 16 cm, 6 1/4" 30-190-16 TC
- 30-190-18 18 cm, 7" 30-190-18 TC
- 30-190-20 20 cm, 8" 30-190-20 TC



BROWN

- 30-196-13 13 cm, 5 1/8"
- 30-196-18 18 cm, 7"

## Needle Holders Porta-agujas



DE BAKEY

30-214-16 TC	16 cm
30-214-18 TC	18 cm
30-214-20 TC	20 cm
30-214-23 TC	23 cm
30-214-26 TC	26 cm
30-214-31 TC	31 cm



RYDER 1 mm

30-224-13 TC	13 cm
30-224-15 TC	15 cm
30-224-18 TC	18 cm
30-224-20 TC	20 cm
30-224-23 TC	23 cm
30-224-26 TC	26 cm

RYDER 2 mm

30-225-13 TC	
30-225-15 TC	
30-225-18 TC	
30-225-20 TC	
30-225-23 TC	
30-225-26 TC	

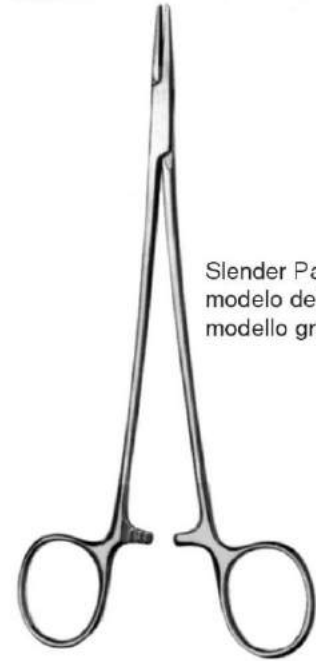

Slender Pattern  
modelo delgado  
modelo gracile

MICROVASCULAR

30-230-18 TC	30-230-20TC
	30-230-23 TC



HEANEY

30-241-21	21 cm, 8 1/4"
30-241-26	26 cm, 10 1/4"
30-241-21 TC	21 cm, 8 1/4"
30-241-26 TC	26 cm, 10 1/4"

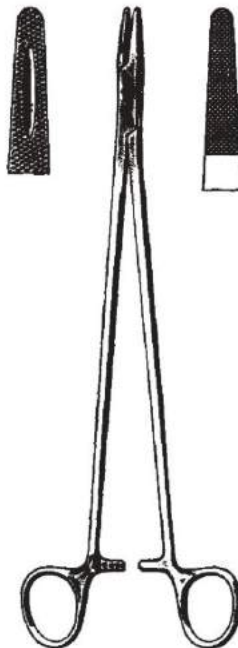

MASSON

30-250-27	27 cm, 10 1/2"
30-250-27 TC	27 cm, 10 1/2"



WANGENSTEEN

30-260-27	27 cm, 10 1/2"
30-260-27 TC	27 cm, 10 1/2"



Needle Holders  
Porta-agujas

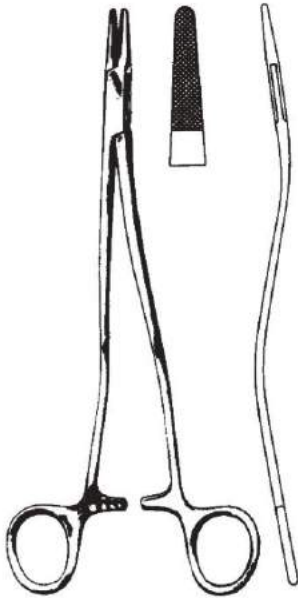

**BOZEMAN**

- 30-285-20 TC 20 cm, 8"
- 30-285-24 TC 24 cm, 9 1/2"
- 30-285-26 TC 26 cm, 10 1/4"



**METZENBAUM**

- 30-290-18
- 18 cm, 7"



**ADSON**

- 30-292-18
- 18 cm, 7"

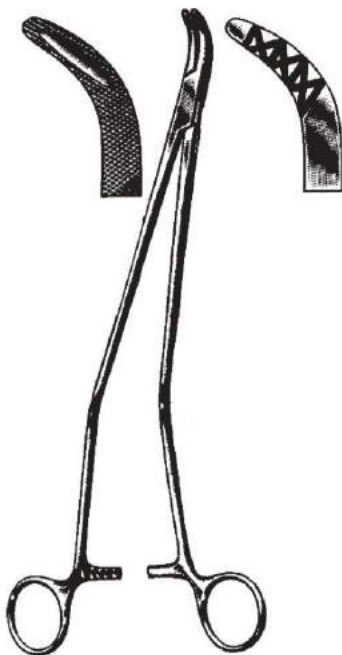

**JOHNSON**

- 30-293-27
- 27 cm, 10 1/2"



**FINOCHIETTO**

- 30-311-20 20 cm, 8" 30-311-20 TC
- 30-311-27 27 cm, 10 1/2" 30-311-27 TC



**SAROT**

- 30-324-18 TC 18 cm, 7"
- 30-324-26 TC 26 cm, 10 1/4"



Needle Holders  
Porta-agujas



STRATTE

- 30-330-21 21 cm, 8 1/4"
- 30-330-23 23 cm, 9" **30-330-23 TC**

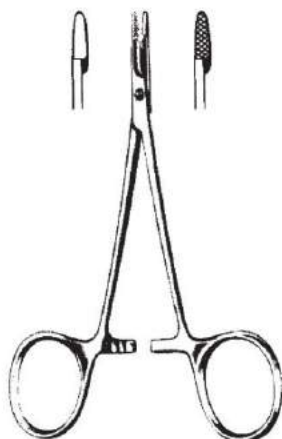

BABY OLSEN-HEGAR

- 30-405-12 30-406-12
- 30-405-12 TC 30-406-12 TC**
- 11.5 cm, 4 1/2"

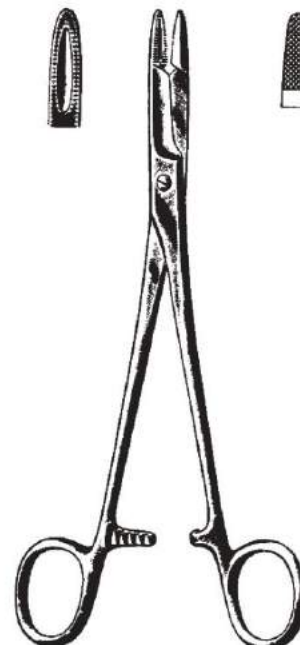

OLSEN-HEGAR

- 30-410-14 14 cm, 5.5" **30-410-14 TC**
- 30-410-17 17 cm, 6.5" **30-410-17 TC**
- 30-410-18 18 cm, 7.5" **30-410-18 TC**



MATHIEU-OLSEN

- 30-415-14 TC** 14 cm, 5 1/2"
- 30-415-17 TC** 17 cm, 6 3/4"
- 30-415-20 TC** 20 cm, 8"



GILLIES

- 11 cm, 4 3/8" **30-430-11 TC**
- 13 cm, 5 1/8" **30-430-13 TC**
- 30-430-16 16 cm, 6 1/4" **30-430-16 TC**

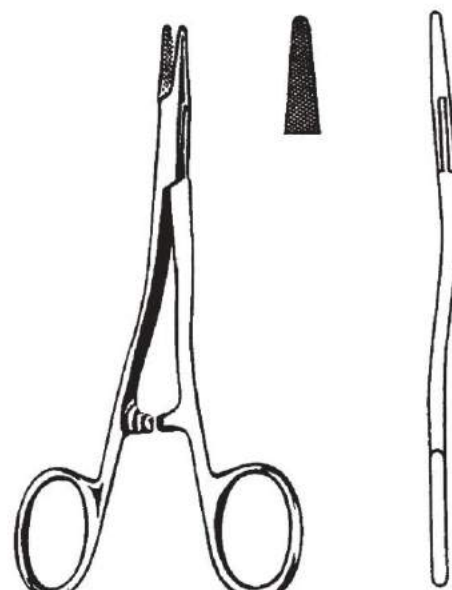

KILNER

- 30-436-13 13 cm, 5 1/8"
- 30-436-13 TC** 13 cm, 5 1/8"



Needle Holders  
Porta-agujas

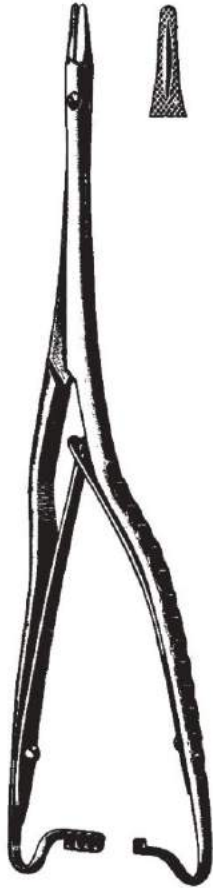

**HOESEL**

30-446-25 25 cm, 10"  
30-446-25 TC 25 cm, 10"



**CRILE**

30-438-15 15 cm, 6"



**MATHIEU**

30-450-14 14 cm, 5 1/2" 30-450-14 TC  
30-450-17 17 cm, 6 3/4" 30-450-17 TC  
30-450-20 20 cm, 8" 30-450-20 TC  
30-450-24 24 cm, 9 1/2" 30-450-24 TC



**LANGENBECK**

30-460-18 TC 18 cm, 7"  
30-460-20 TC 20 cm, 8"  
30-460-23 TC 23 cm, 9"



**HOESEL**

30-465-20 TC 20 cm, 8"  
30-465-25 TC 25 cm, 10"



**LICHTENBERG**

30-466-17 17 cm, 6 3/4" 30-466-17 TC  
30-466-20 20 cm, 8" 30-466-20 TC



## Needle Holders Porta-agujas

Ophthalmology  
Oftalmología  
Oftalmología



STEVENS  
30-610-11  
11 cm, 4 3/8"



STEVENS  
30-612-13 13 cm, 5 1/8"  
30-612-15 15 cm, 6"

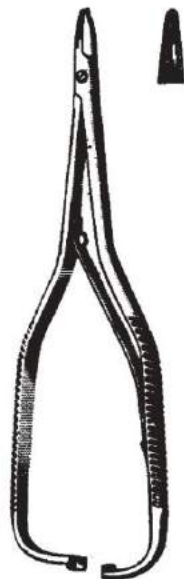

BOYNTON  
30-614-12  
12 cm, 4 3/4"



BOYNTON  
**30-614-12 TC**  
12 cm, 4 3/4"



ARRUGA  
30-620-16 30-621-16  
16 cm, 6 1/4"

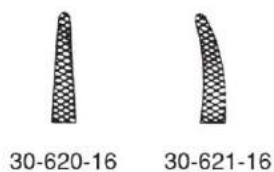

**30-620-16 TC** **30-621-16 TC**

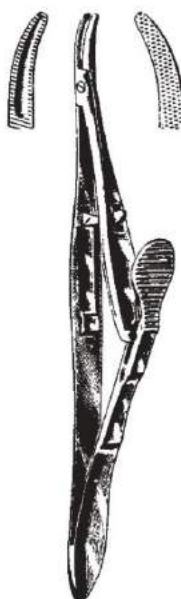

KALT-ARRUGA  
30-627-14  
14 cm, 5 1/2"



KALT  
30-628-14  
14 cm, 5 1/2"



Needle Holders  
Porta-agujas

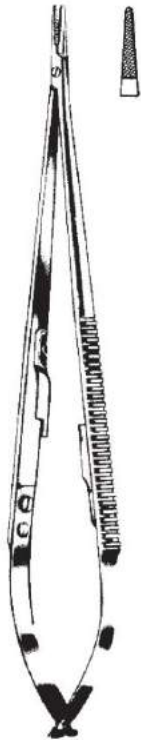

**JACOBSON**  
30-667-18 18 cm, 7"  
30-667-18 TC 18 cm, 7"

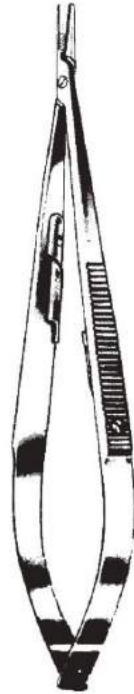

**CASTROVIEJO**  
14 cm, 5 1/2"



30-670-14  
Smooth  
lisa  
liscia



30-672-14  
Serrated  
estriada  
zigrinato



30-676-14 TC



30-671-14  
Smooth  
lisa  
liscia



30-673-14  
Serrated  
estriada  
zigrinato



30-677-14 TC



30-678-09



**CASTROVIEJO Micro**  
9 cm, 3 1/2"



30-679-09



**CASTROVIEJO**  
30-680-13 13 cm, 5 1/8"  
30-680-13 TC 13 cm, 5 1/8"



Micro Needle Holders  
Micro Porta-agujas



CASTROVIEJO  
30-678-14 14 cm, 5 1/2"



CASTROVIEJO  
30-679-14 14 cm, 5 1/2"



30-650-10 30-651-10

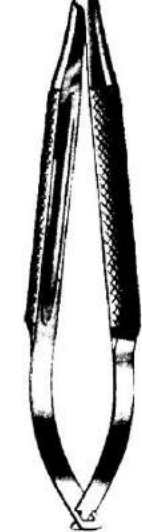

BARRAQUER  
10 cm, 4"

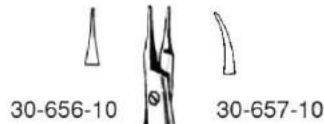

30-656-10 30-657-10



BARRAQUER-TROUTMAN  
10 cm, 4"





Micro Needle Holders  
Micro Porta-agujas



30-660-13

30-661-13

**BARRAQUER**  
13 cm, 5"

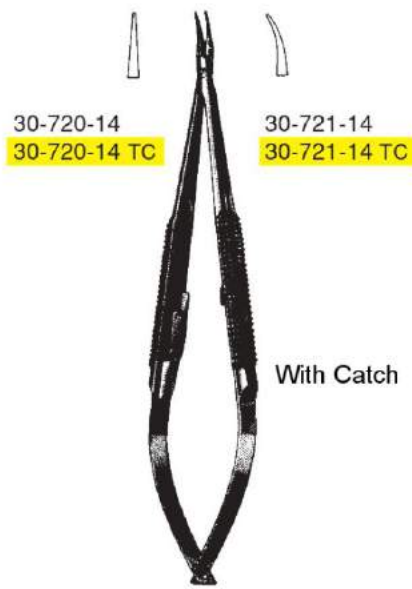

30-720-14  
30-720-14 TC

30-721-14  
30-721-14 TC

With Catch

**BARRAQUER**  
14 cm, 5 1/2"



30-700-18

30-701-18

**BARRAQUER**  
18 cm, 7"



30-730-18

30-731-18

With Catch

**BARRAQUER**  
18 cm, 7"



Ligature Needles  
Agujas para ligaduras



Malleable  
maleable  
malleabile

32-109-20

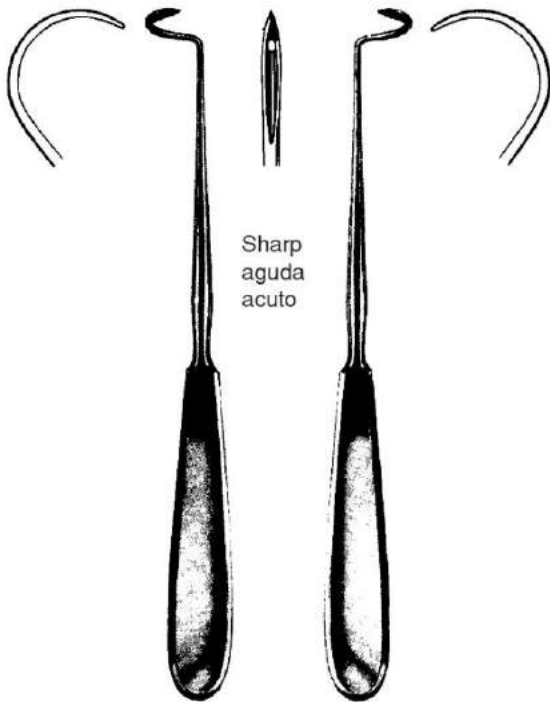

Sharp  
aguda  
acuto

Blunt  
roma  
smusso

	L	DESCHAMPS	R
	32-110-21	21 cm, 8 1/4"	32-111-21
	32-110-24	24 cm, 9 1/2"	32-111-24
	32-110-27	27 cm, 10 1/2"	32-111-27

	L	DESCHAMPS	R
	32-120-21	21 cm, 8 1/4"	32-121-21
	32-120-24	24 cm, 9 1/2"	32-121-24
	32-120-27	27 cm, 10 1/2"	32-121-27



Ligature Needles  
Agujas para ligaduras

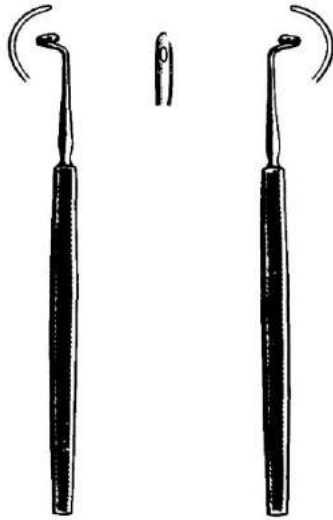

L KRONECKER R  
32-130-13 32-131-13  
13 cm, 5 1/8"

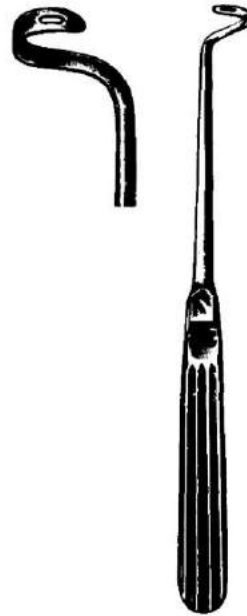

L NELSON R  
32-133-24 32-135-24  
24.5 cm, 9 3/4"



SCHMIEDEN-DICK  
32-134-32 32 cm, 12 3/4"

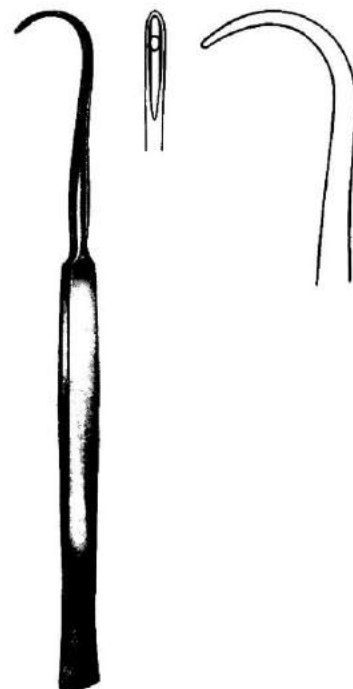

COOPER  
32-139-19 19 cm, 7 1/2"

## Suturing Instruments Instrumentos para suturas

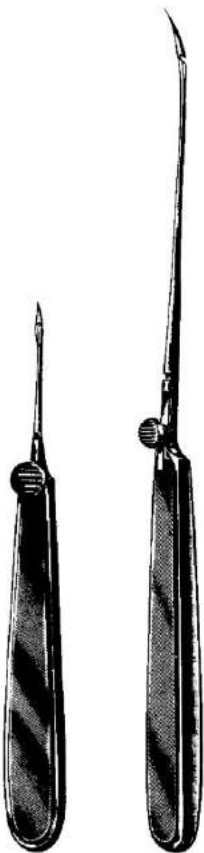

REVERDIN  
32-201-15 to 32-204-21



Fig. 1  
32-201-15 15 cm, 6"  
32-201-19 19 cm, 7 1/2"  
32-201-21 21 cm, 8 1/4"



Fig. 2  
32-202-15 15 cm, 6"  
32-202-19 19 cm, 7 1/2"  
32-202-21 21 cm, 8 1/4"



Fig. 3  
32-203-15 15 cm, 6"  
32-203-19 19 cm, 7 1/2"  
32-203-21 21 cm, 8 1/4"



Fig. 4  
32-204-15 15 cm, 6"  
32-204-19 19 cm, 7 1/2"  
32-204-21 21 cm, 8 1/4"



YOUNG BOOMERANG  
32-240-00  
25 cm, 10"



Fig. 1  
32-240-01



Fig. 2  
32-240-02



Fig. 3  
32-240-03



Ligature Conducto.  
Sondas conductoras

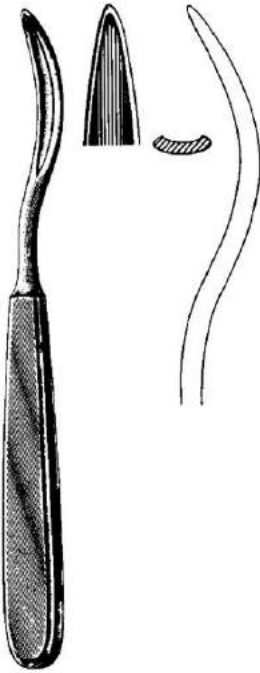

**SCHMIEDEN**  
32-271-19  
19 cm, 7 1/2"

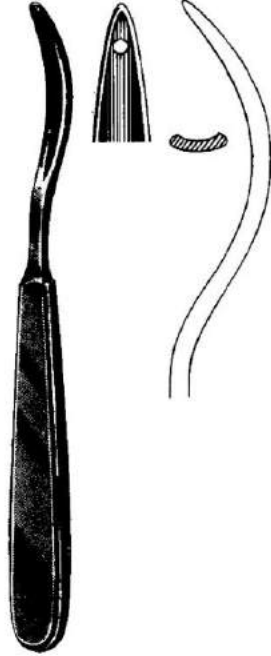

**SCHMIEDEN-PAYR**  
32-273-19  
19 cm, 7 1/2"

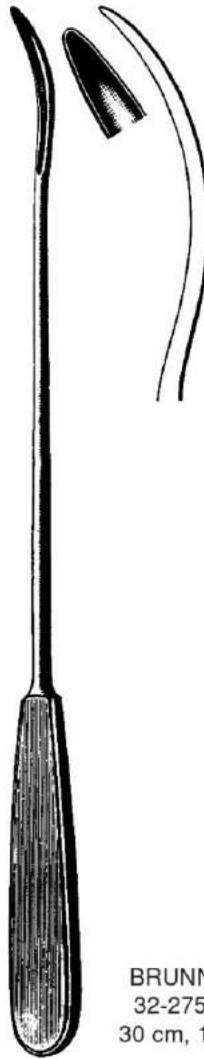

**BRUNNER**  
32-275-30  
30 cm, 11 3/4"

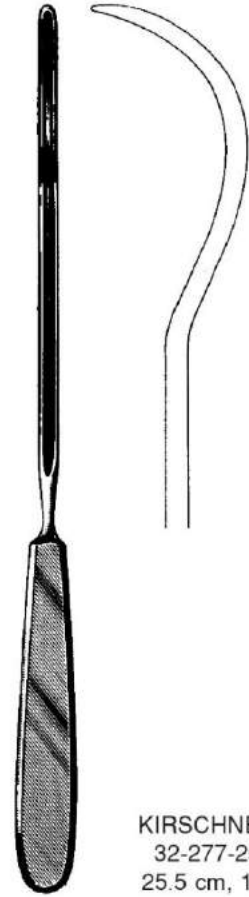

**KIRSCHNER**  
32-277-25  
25.5 cm, 10"

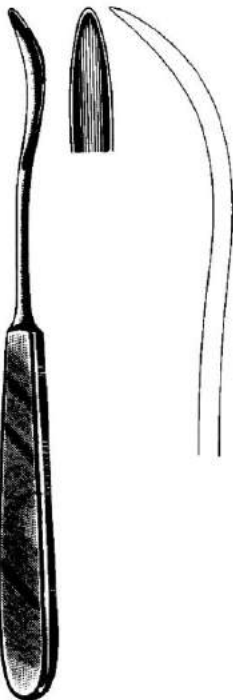

**KOENIG**  
32-285-20  
20 cm, 8"



**PAYR**  
32-288-22  
22 cm, 8 3/4"



**PAYR**  
32-289-22  
22 cm, 8 3/4"

Plastic  
plástica



**BRUNNER**  
32-291-18 18 cm, 7"  
32-291-27 27 cm, 10 1/2"



**VIENNA**  
32-297-23  
23.5 cm, 9 1/4"



**ANMUTH**  
32-298-23  
23 cm, 9"



## Suture Needles Agujas para suturas

Packages of 1 Dozen  
en sobres de 1 docena  
confezione 1 dozzina

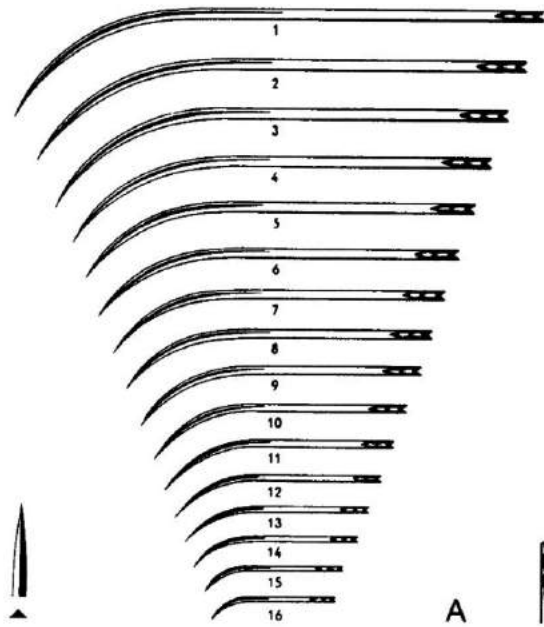

32-403-01 to 32-403-16

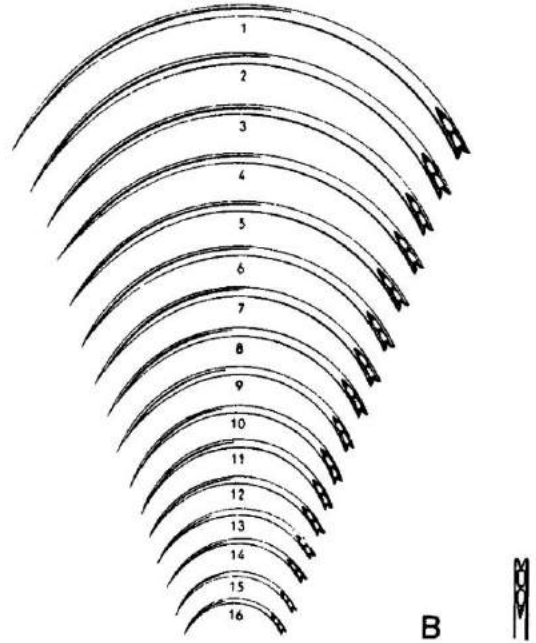

32-413-01 to 32-413-16

Fig.	1	2	3	4	5	6	7	8	9	10	11	12	13	14	15	16
A	32-403-01	32-403-02	32-403-03	32-403-04	32-403-05	32-403-06	32-403-07	32-403-08	32-403-09	32-403-10	32-403-11	32-403-12	32-403-13	32-403-14	32-403-15	32-403-16
B	32-413-01	32-413-02	32-413-03	32-413-04	32-413-05	32-413-06	32-413-07	32-413-08	32-413-09	32-413-10	32-413-11	32-413-12	32-413-13	32-413-14	32-413-15	32-413-16
G	32-423-01	32-423-02	32-423-03	32-423-04	32-423-05	32-423-06	32-423-07	32-423-08	32-423-09							
Ga	32-433-01	32-433-02	32-433-03	32-433-04	32-433-05	32-433-06	32-433-07	32-433-08	32-433-09	32-433-10	32-433-11	32-433-12	32-433-13	32-433-14	32-433-15	32-433-16
Gr	32-434-01	32-434-02	32-434-03	32-434-04	32-434-05	32-434-06	32-434-07	32-434-08	32-434-09	32-434-10	32-434-11	32-434-12	32-434-13	32-434-14	32-434-15	32-434-16

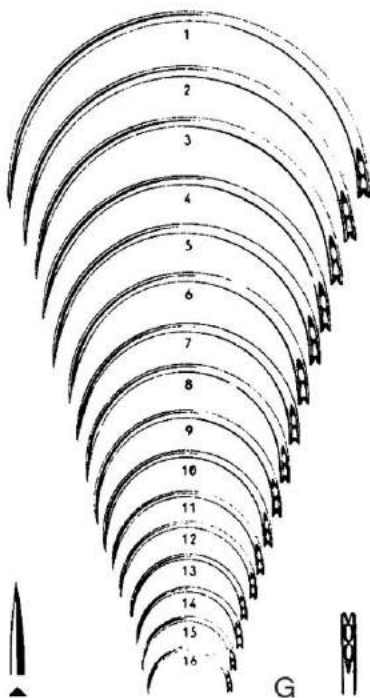

32-423-01 to 32-423-16

All Needles with Spring Eye  
todas las agujas con ojo a resorte  
tutti gli aghi con cruna aperta

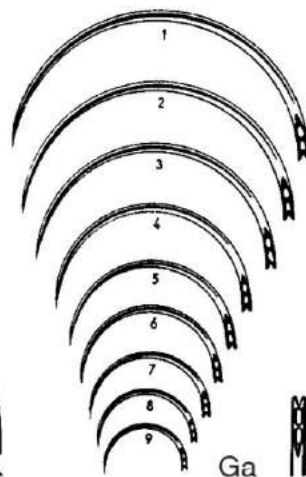

32-433-01 to 32-433-09

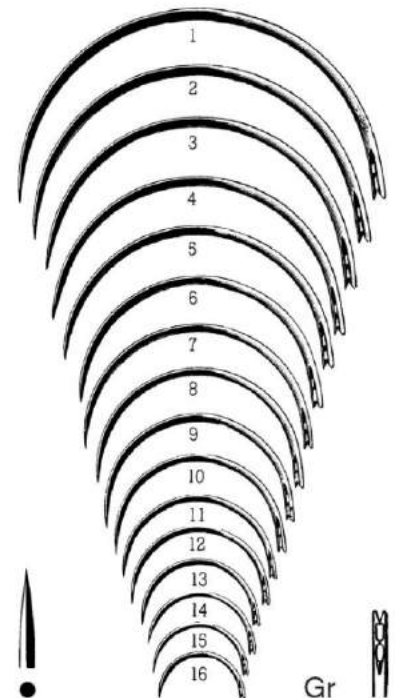

32-434-01 to 32-434-16



## Suture Needles Agujas para suturas

All Needles with Spring Eye  
todas las agujas con ojo a resorte  
tutti gli aghi con cruna aperta

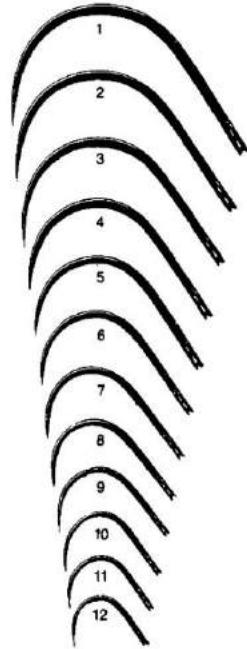

32-441-01 to 32-441-12

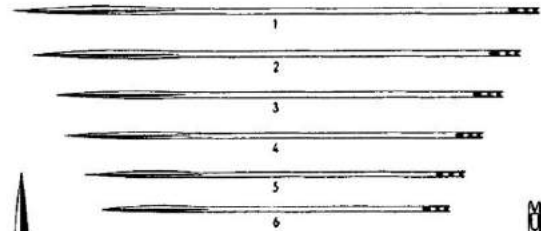

KEITH  
32-450-01 to 32-450-06

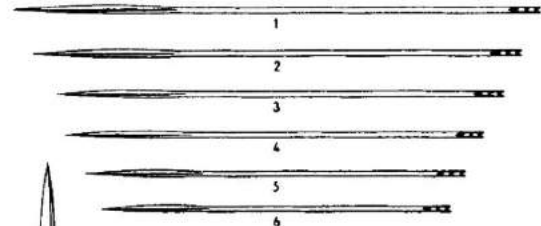

KEITH  
32-452-01 to 32-452-06

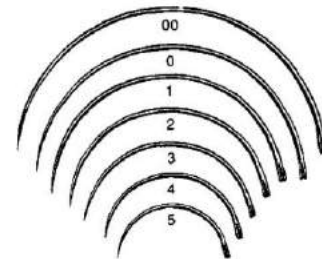

32-465-20 to 32-467-05 **Pb**

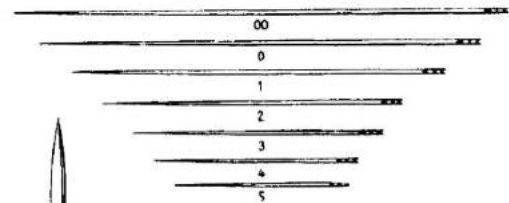

32-475-20 to 32-477-05 **Pc**

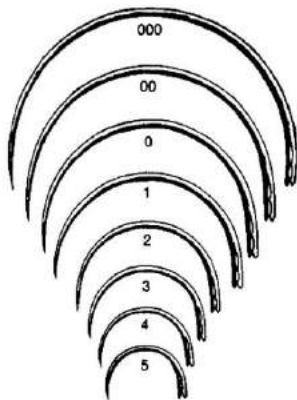

32-443-30 to 32-443-05

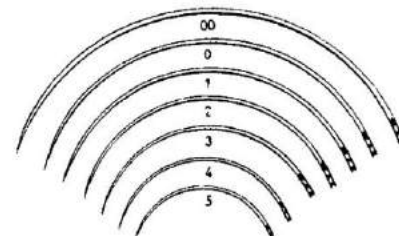

32-485-20 to 32-487-05 **Pd**

FIG.	000	00	0	1	2	3	4	5	6	7	8	9	10	11	12
KÖNIG				32-441-01	32-441-02	32-441-03	32-441-04	32-441-05	32-441-06	32-441-07	32-441-08	32-441-09	32-441-10	32-441-11	32-441-12
E	32-443-30	32-443-20	32-443-10	32-443-01	32-443-02	32-443-03	32-443-04	32-443-05							
KEITH				32-450-01	32-450-02	32-450-03	32-450-04	32-450-05	32-450-06						
KEITH				32-452-01	32-452-02	32-452-03	32-452-04	32-452-05	32-452-06						
Pb		32-465-20	32-465-10	32-467-01	32-467-02	32-467-03	32-467-04	32-467-05							
Pc		32-475-20	32-475-10	32-477-01	32-477-02	32-477-03	32-477-04	32-477-05							
Pd		32-485-20	32-485-10	32-487-01	32-487-02	32-487-03	32-487-04	32-487-05							



## Clips and Instruments Agrafes e instrumentos



CHILDE  
32-620-18  
18 cm, 7"



MICHEL  
32-610-12  
12 cm, 4 3/4"



WACHENFELDT  
32-612-12  
12.5 cm, 5"



WACHENFELDT  
32-614-12  
12.5 cm, 5"



HEGENBARTH  
32-616-12  
12.5 cm, 5"



MICHEL  
32-630-12  
12 cm, 4 3/4"

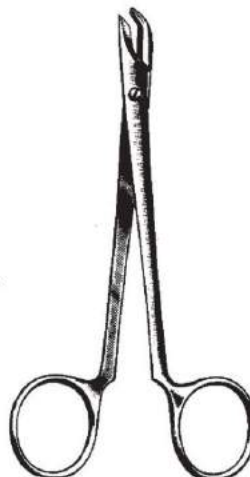

COLLIN  
32-640-13  
13 cm, 5 1/8"

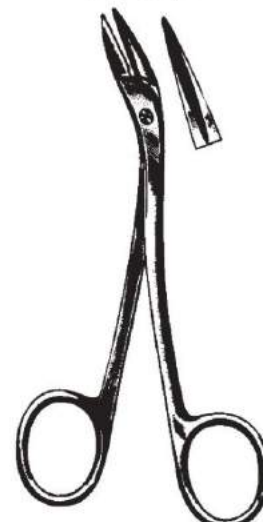

RICHTER-HEATH  
32-642-14  
14 cm, 5 1/2"

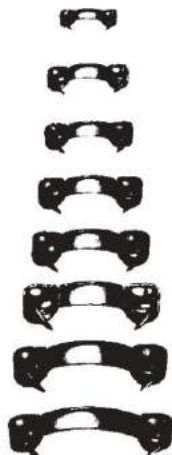

MICHEL

MICHEL	mm
32-660-07	7.5 x 1.75
32-660-11	11 x 2
32-660-12	12 x 3
32-660-14	14 x 3
32-660-16	16 x 3
32-660-18	18 x 3
32-660-20	20 x 3
32-660-22	22 x 3

Box of 1000  
paq x 1000  
confezione x 1000





## Pocket Suturing Kit Estuche de bolsillo y de sutura



32-670-00  
130 x 45 x 18 mm

Suture Clip Set in Metal Case,  
Consisting of:  
MICHEL Suture Clip Forceps  
WACHENFELDT Approximation Forceps, with Clip  
Rack  
50 MICHEL Suture Clips

Estuche para sutura, en caja de metal,  
compuesto de:  
Pinza para agrafes de Michel  
Pinza para juntar los bordes de la herida,  
de Wachenfeldt, con porta-agrafas  
50 Agrafes (Grapas) de Michel

Set di clip per suture in astuccio di metallo  
composto da:  
Pinza di Michel per clip  
Pinza Wachenfeldt con fermagli per sutura  
50 Agrafes di Michel



## Pocket Suturing Kit Estuche de bolsillo y de sutura



STANDARD

32-680-00  
165 x 90 x 28 mm

Complete in Metal Case with Plastic Pouch and  
2 removable Perforated Trays for Instruments

### Contents:

- 1 Mathieu Needle Holder, 14 cm, 5 1/2"
- 1 Flacon with sterilized silk in alcohol
- 6 Suture Needles, assorted
- 1 Needle Case, 25.6" x 16.5", perforated
- 1 Michel Suture Clip Forceps
- 20 Michel Suture Clips with Clip Holder
- 1 Scalpel Handle with Blade
- 3 Scalpel Blades, interchangeable
- 1 Scissors, straight, blunt/sharp, 13 cm, 5"
- 1 Dressing Forceps, 11.5 cm, 4 1/2"
- 1 Tissue Forceps, 12 cm, 4 3/4", 1 x 2 teeth
- 1 Carmalt Splinter Forceps, 10,5 cm, 4 1/4"
- 1 Kocher Artery Forceps, straight, 13 cm, 5"
- 1 Probe with myrtle leaf, 13 cm, 5"

Completo en caja de metal con bolsa de plástico y 2  
bandejas perforadas para los instrumentos

### Contenido:

- 1 Porta-aguja de Mathieu, 14 cm (5 1/2")
- 1 Frasco con seda esterilizada para sutura, en alcohol
- 6 Agujas de sutura surtidas
- 1 Cajita para agujas, 65 x 42 mm, perforada
- 1 Pinza para agrafes de Michel
- 20 Agrafes de Michel, en su porta-agrafe
- 1 Mango de bisturi, con hoja intercambiable
- 3 Hojas intercambiables surtidas
- 1 Tijera, recta, roma/aguda, 13 cm (5")
- 1 Pinza de disección, 11,5 cm (4 1/2")
- 1 Pinza de disección, con 1 x 2 dientes, 12 cm (4 3/4")
- 1 Pinza para espinas de Hunter, 10,5 cm (4 1/4")
- 1 Pinza hemostática de Kocher, 13 cm (5"), S.
- 1 Estilete abotonado, multiforme, 13 cm (5")

Astuccio tascabile con due  
supporti estraibili

### Contenente:

- 1 Port aghi di Mathieu 14 cm (5 1/2")
- 1 Set per suture in flacone di vetro
- 6 aghi per sutura assortiti
- 1 scatola per aghi 65 x 24 perforata
- 1 pinza per sutura di Michel
- 20 Agrafe Michel ed porta agrafe
- 1 Manico da bisturi per lama intercambiabile
- 3 lame da bisturi intercambiabili
- 1 forbici rette alterne 13 cm (5")
- 1 pinze da dissezione
- 1 pinze da dissezione 1 x 2 denti
- 1 pinze di Hunter per schegge 10,5 cm (4 1/4")
- 1 pinze emostatiche di Kocher 13 cm (5")
- 1 specillo bottonuto 13 cm (5")



## Sterilization Instruments and Holders Instrumentos para la esterilización, Pinza para desechos, Cadres de esterilización



**DAVIS**  
 34-102-16 16 cm, 6 1/4"  
 34-102-20 20 cm, 8"  
 34-102-24 24 cm, 9 1/2"



**CHEATLE**  
 34-110-27  
 27 cm, 10 1/2"



**UNIVERSAL**  
 34-120-20 20 cm, 8"  
 34-120-28 28 cm, 11"

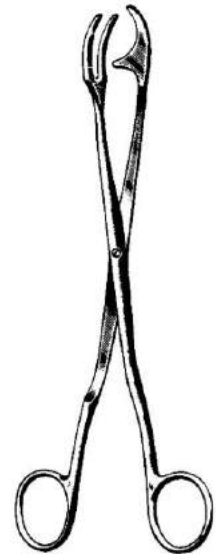

**ROGGE**  
 34-130-23  
 23 cm, 9"



34-140-20 20 cm, 8"  
 34-140-30 30 cm, 11 3/4"



**SAUERBRUCH**  
 34-145-55  
 55 cm, 21.7"



**BUNT**  
 34-150-12 12 cm, 4 3/4"

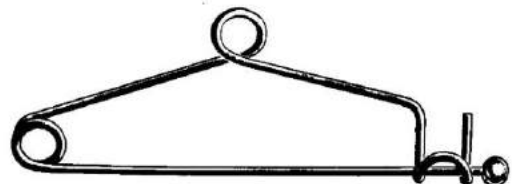

**MAYO**  
 34-152-14 14 cm, 5 1/2"



Notes

A series of horizontal lines provided for taking notes.



Plaster of Paris Shears  
Cizallas para vendajes enyesados

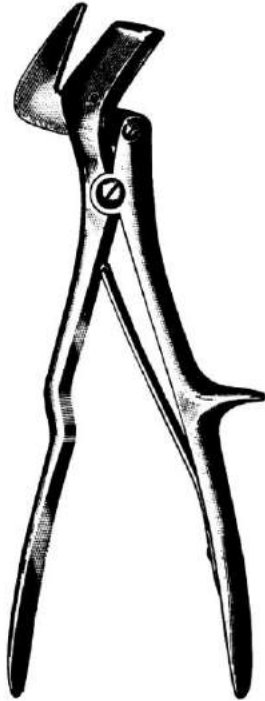

STILLE  
36-101-24 24 cm, 9 1/2"



STILLE  
36-103-23 23 cm, 9"  
36-103-26 26 cm, 10 1/4"  
36-103-37 37 cm, 14 1/2"



WIGMORE  
36-120-19 19 cm, 7.5"

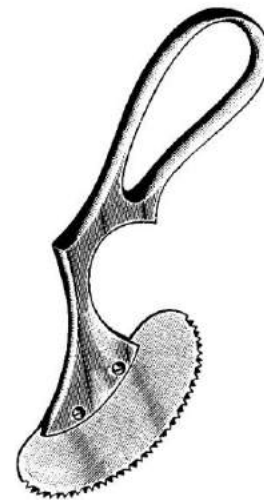

ENGEL  
36-130-14 15 cm, 6"



## Oscillating Plaster Saw Sierra oscilante p. vendajes enyesados

Electric Plaster Cast Cutter  
Sierra eléctrica para yesos  
Sega elettrica per gessi



36-210-21 110 Volt Complete with 36-212-02 / 36-210-50 / 36-210-65  
36-210-22 230 Volt Complete with 36-212-02 / 36-210-50 / 36-210-65

Decibel Level: Minimum 63 Maximum 69 db/A  
Nivel de ruido del aparato sólo 63 dB (min.), 69 dB/A  
Livello acustico dello strumento solo: min. 63 max. 69 db/A

EN 60601-1, EN 60601-1-2, IEC 60601-1, IEC 60601-1-2



36-212-02  
Wrench  
Llaves

Paio di Chiavi per utilizzo cambio lame da sega

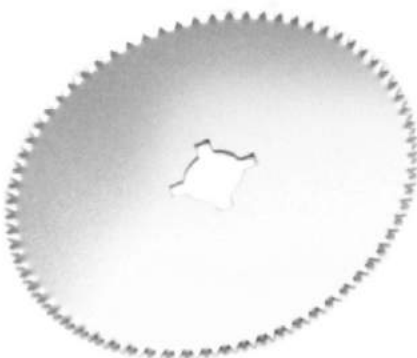

36-210-50	50 mm, 2.0" Ø *
36-210-65	65 mm, 2.6" Ø *
36-211-50	50 mm, 2.0" Ø *
36-211-65	65 mm, 2.6" Ø *

- \* Saw Blades - Specially Hardened for Use with Fiberglass or Similar Material
- \* Hojas de repuesto, templadas especialmente (para vendajes de fibra de vidrio y otros vendajes duros)
- \* Lame per sega a tempera speciale per bendaggi (in fibro di vetro ed altri bendaggi duri)

Oscillating Plaster Saw with Plaster Vacuum  
Sierra oscilante con aspiraciòn



36-250-00



Plaster Cast Instruments  
Instrumentos para vendajes enyesados

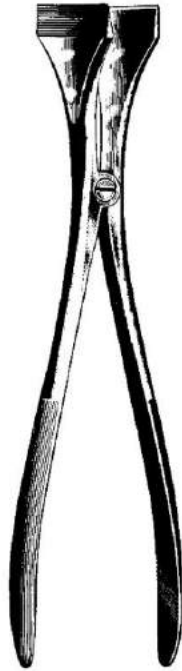

HENNIG  
36-350-28 28 cm, 11"

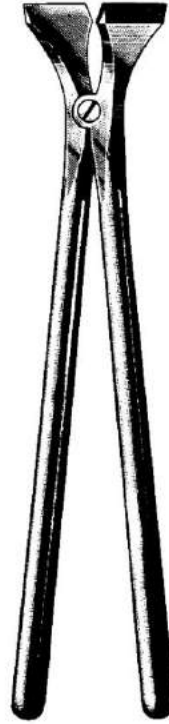

BEESON  
36-360-30 30 cm, 11 3/4"

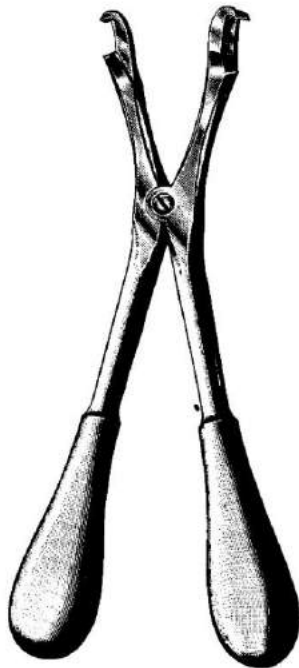

HAGLUND-STILLE  
36-362-28 28 cm, 11"



BOOTNAS  
36-366-23 23 cm, 9"





## Plaster Cast Instruments, Knives Instrumentos para vendajes enyesados, Cuchillios



HOPKINS  
36-370-20  
20 cm, 8"



ESMARCH  
36-380-18  
18 cm, 7"

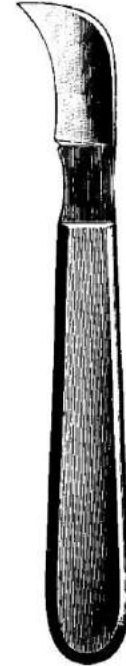

REINER  
36-390-18  
18 cm, 7"



WOLFF  
36-395-18  
18 cm, 7"



WOLFF  
36-397-24  
24 cm, 9 1/2"



## Bone Rongeurs Pinzas-gubias

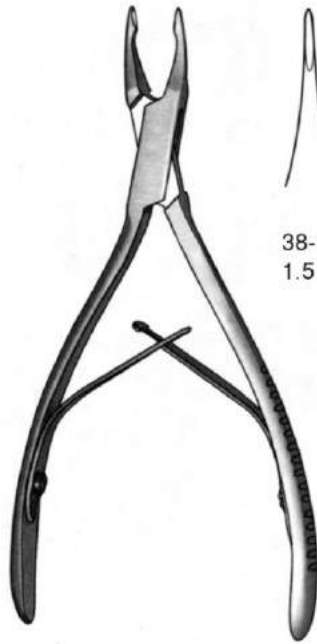

Micro FRIEDMAN  
38-100-02 14 cm, 5 1/2"



38-100-01  
1.5 x 5 mm



38-100-02  
1.5 x 5 mm

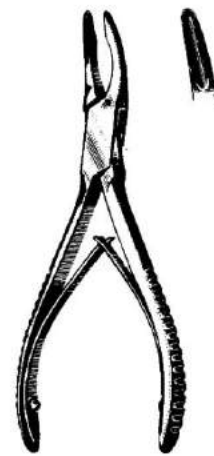

Mini FRIEDMAN  
38-101-12 12 cm, 4 3/4"

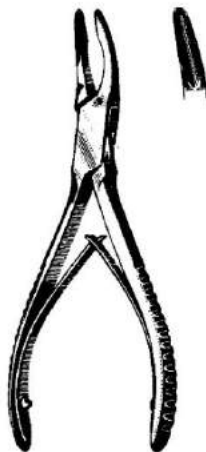

FRIEDMAN  
38-101-14 14 cm, 5 1/2"



STELLBRINK  
38-102-02 17 cm, 6 3/4"

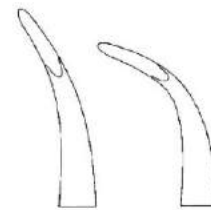

38-102-01  
2 mm



38-102-02  
2 mm



Bone Rongeurs  
Pinzas-gubias



CLEVELAND  
38-103-14 14 cm, 5 1/2"

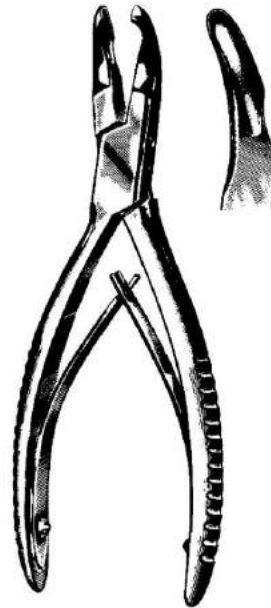

CLEVELAND  
38-105-17 17 cm, 6 3/4"

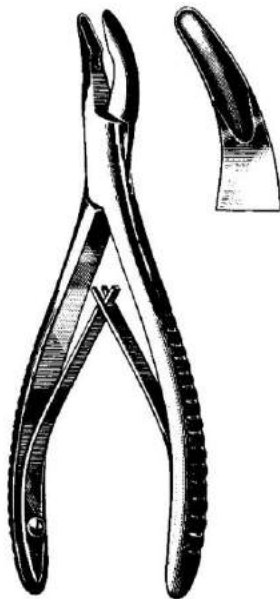

MEAD  
38-107-16 16.5 cm, 6 1/2"

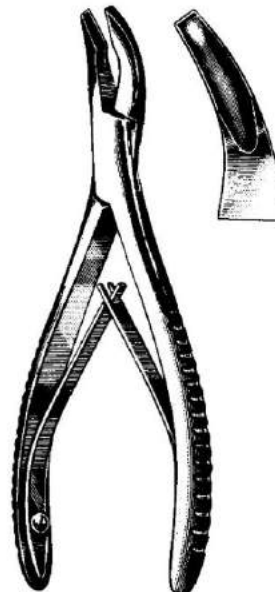

MEAD  
38-109-16 16.5 cm, 6 1/2"

Bone Rongeurs  
Pinzas-gubias



BLUMENTHAL  
38-115-15  
15 cm, 6"

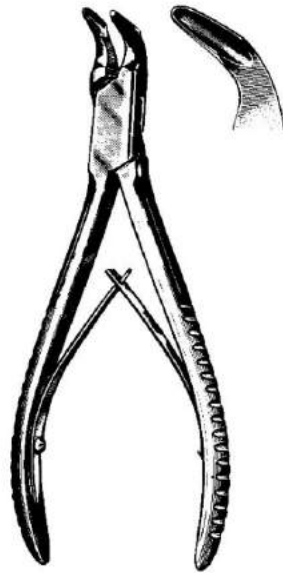

BLUMENTHAL  
38-117-15  
15 cm, 6"

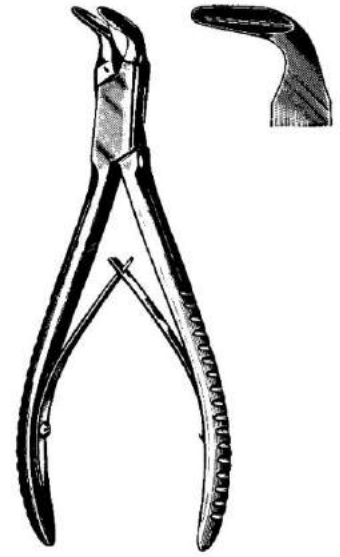

BLUMENTHAL  
38-119-15  
15 cm, 6"

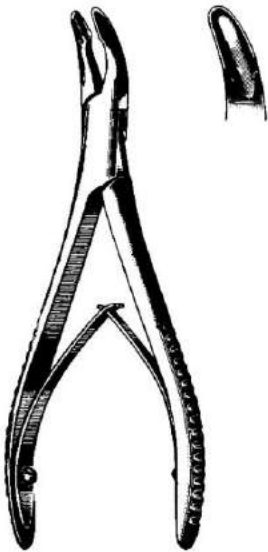

LUER  
38-131-15  
15 cm, 6"

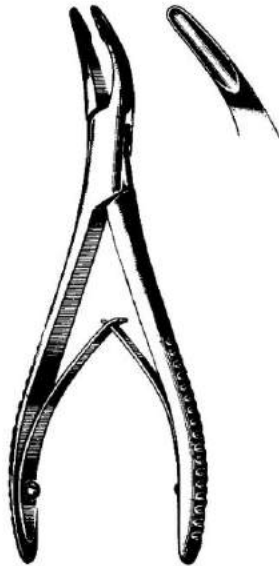

LUER  
38-133-15  
15 cm, 6"

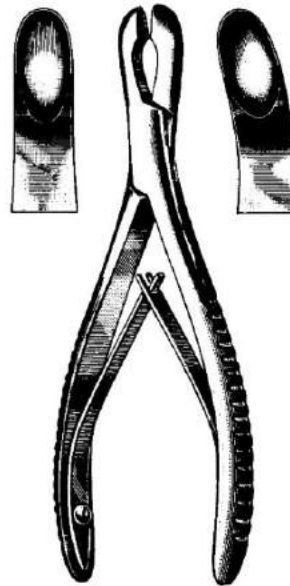

LUER  
38-136-17 38-137-17  
17 cm, 6 3/4"



ADSON  
38-142-20 38-143-20  
20 cm, 8"



Bone Rongeurs  
Pinzas-gubias

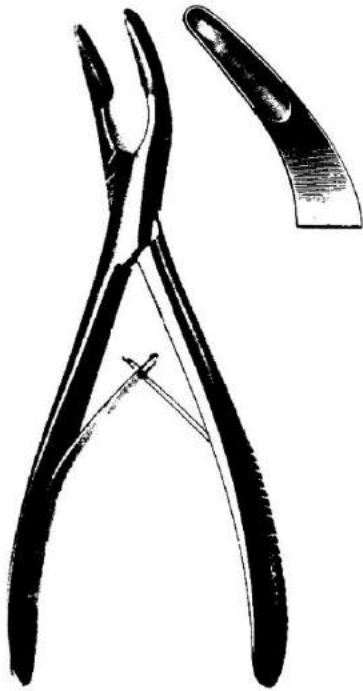

**OLIVECRONA**  
38-147-20  
20 cm, 8"



**BANE-HARTMANN**  
38-148-18  
18 cm, 7"



**LEMPERT**  
38-150-16 38-151-16  
16 cm, 6 1/4"



**JANSEN**  
17 cm, 6 3/4"

38-152-17 38-153-17



**LEMPERT**  
38-154-18 38-155-18  
18.5 cm, 7 1/4"



**BEYER**  
38-156-18  
18 cm, 7"

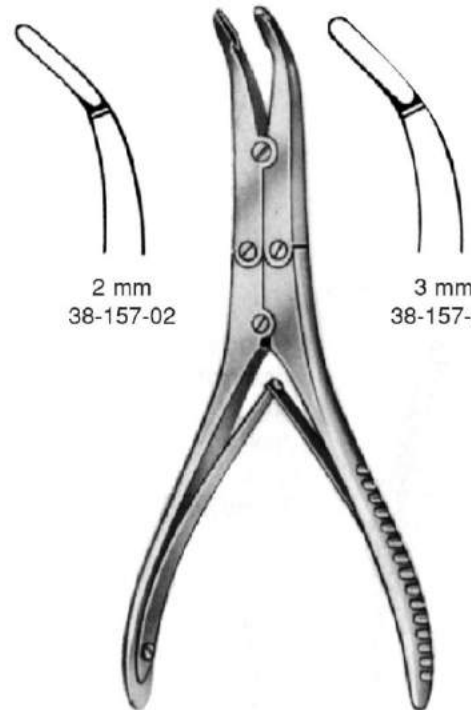

**KLEINERT-KUTZ**  
15 cm, 6"

2 mm  
38-157-02

3 mm  
38-157-03



Bone Rongeurs  
Pinzas-gubias

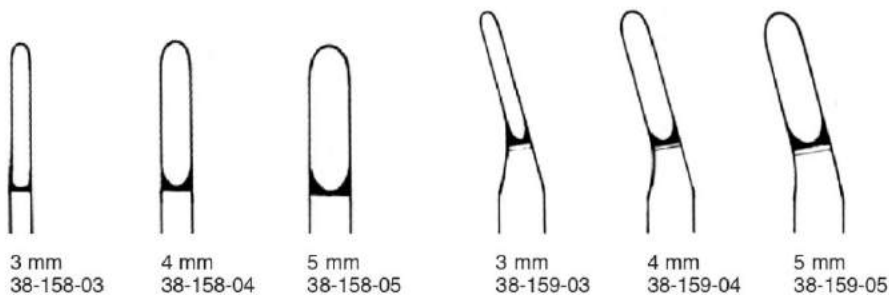

3 mm  
38-158-03

4 mm  
38-158-04

5 mm  
38-158-05

3 mm  
38-159-03

4 mm  
38-159-04

5 mm  
38-159-05

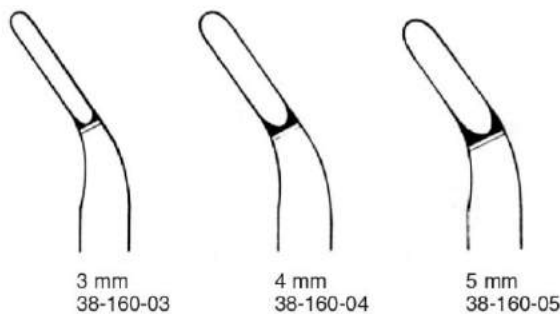

3 mm  
38-160-03

4 mm  
38-160-04

5 mm  
38-160-05



SMITH-PETERSEN  
24 cm, 9 1/2"  
38-158-03 to 38-158-05  
38-159-03 to 38-159-05  
38-160-03 to 38-160-05

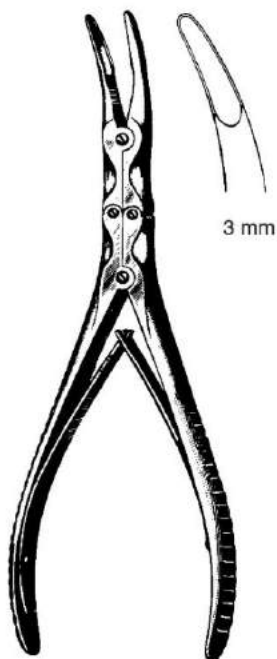

BEYER  
38-201-18  
18 cm, 7"



MAYFIELD  
38-202-18  
18 cm, 7"

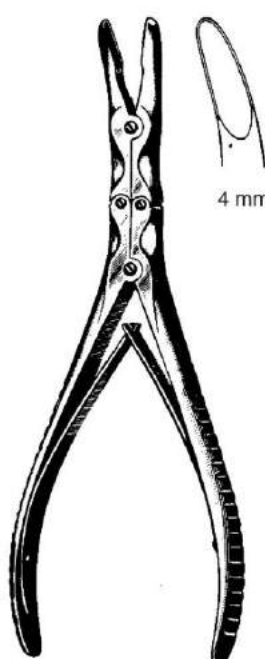

ZAUFAL-JANSEN  
38-205-18  
18 cm, 7"



RUSKIN  
38-211-15 38-213-15  
15 cm, 6"



**Bone Rongeurs  
Pinzas-gubias**

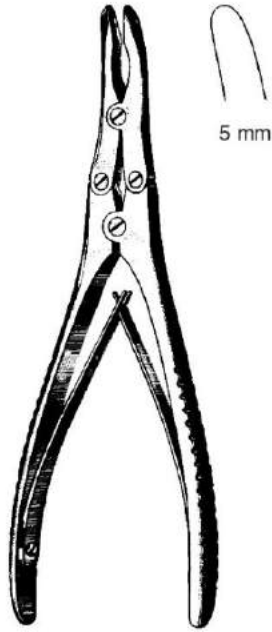

**RUSKIN**  
38-216-18 38-217-18  
18 cm, 7"



**RUSKIN**  
38-219-23 23 cm, 9"



**MARQUARDT**  
38-220-20 20 cm, 8"



**STILLE-LUER**  
38-230-22 22 cm, 8 3/4" 38-231-22  
38-230-26 26 cm, 10 1/4" 38-231-26

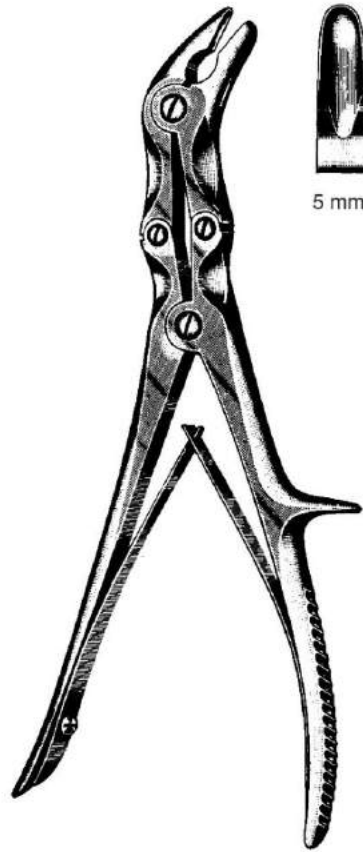

**STILLE-LUER**  
38-235-23  
23 cm, 9"

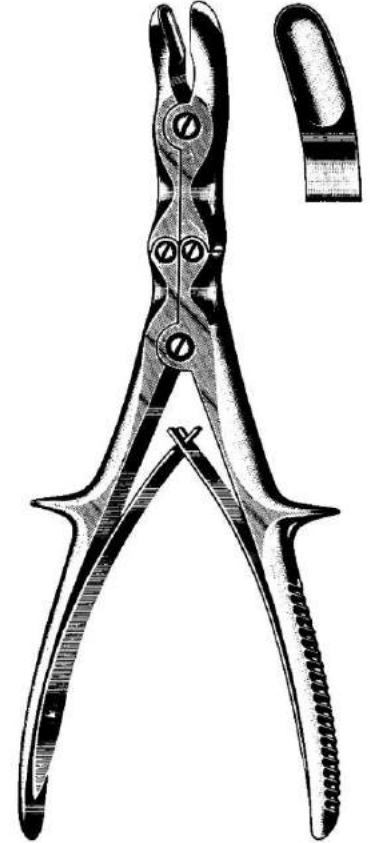

**STILLE-RUSKIN**  
38-237-23  
23 cm, 9"

## Bone Rongeurs Pinzas-gubias

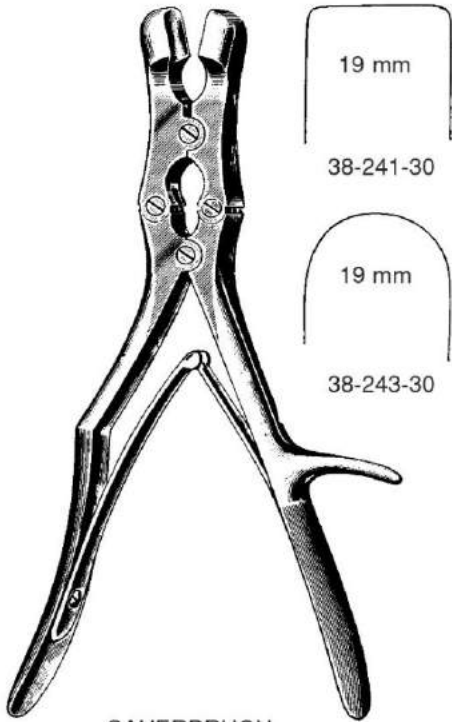

**SAUERBRUCH**  
30 cm, 12"

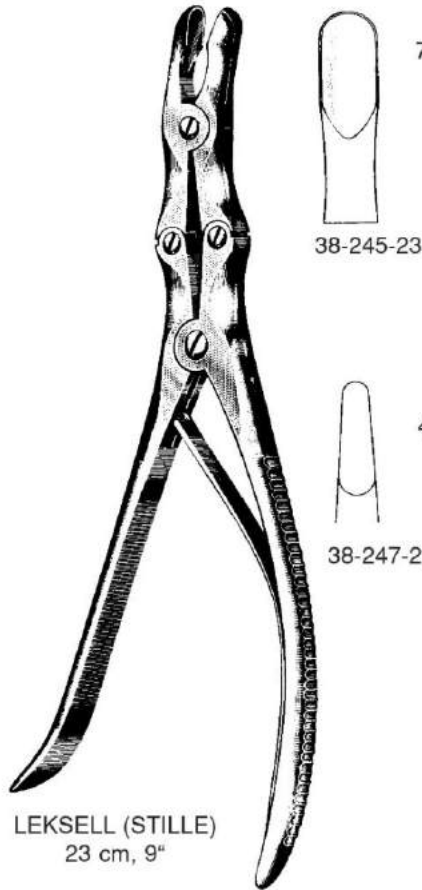

**LEKSELL (STILLE)**  
23 cm, 9"

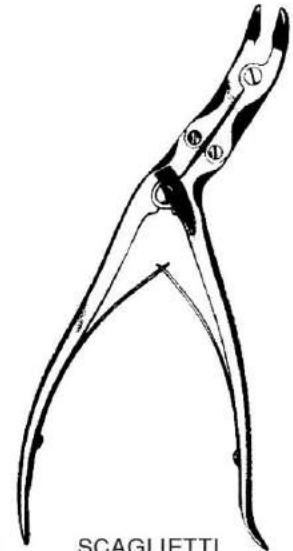
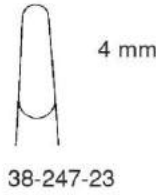
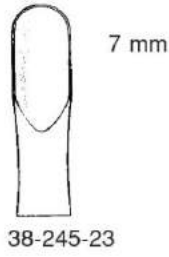

**SCAGLIETTI**  
R 38-251-26 L 38-253-26  
26 cm, 10 1/4"  
Right derecha Left izquierda  
a destra a sinistra



**ECHLIN**  
38-257-23 2 mm  
38-258-23 3 mm  
38-259-23 4 mm  
23 cm, 9"



**FRYKHOLM**  
38-260-24  
24 cm, 9 1/2"

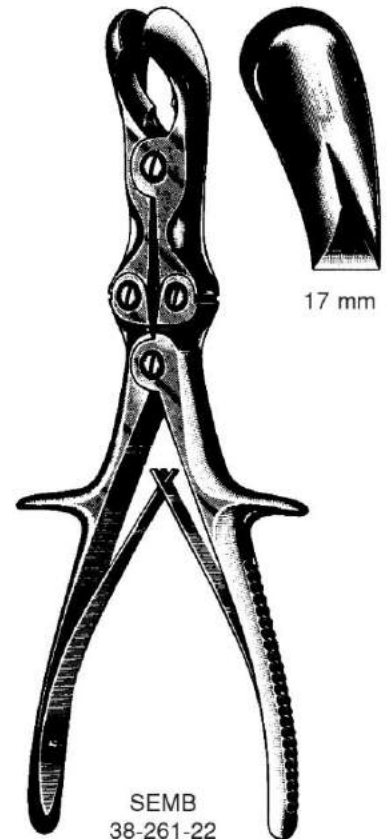

**SEMB**  
38-261-22  
22.5 cm, 8.9"





**Bone Cutting Forceps**  
**Pinzas contantes para huesos**

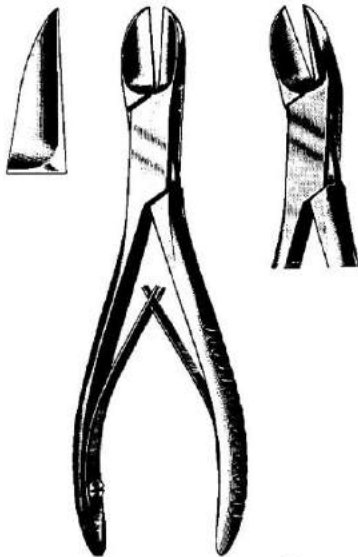

**LISTON**

38-274-14	14 cm, 5 1/2"	38-275-14
38-274-17	17 cm, 6 3/4"	38-275-17
38-274-19	19 cm, 7 1/2"	38-275-19
38-274-22	22 cm, 8 3/4"	38-275-22
38-274-27	27 cm, 10 1/2"	



**RUSKIN**

38-280-15	38-281-15
15 cm, 6"	



**COTTLE-KAZANJIAN**

38-282-19
19 cm, 7 1/2"



**Mc INDOE**

38-283-17
17 cm, 6 3/4"

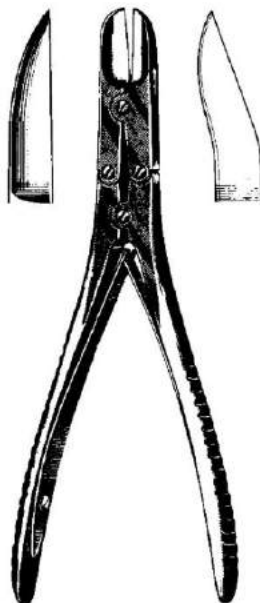

**RUSKIN-LISTON**

38-286-18	38-289-18
18 cm, 7"	

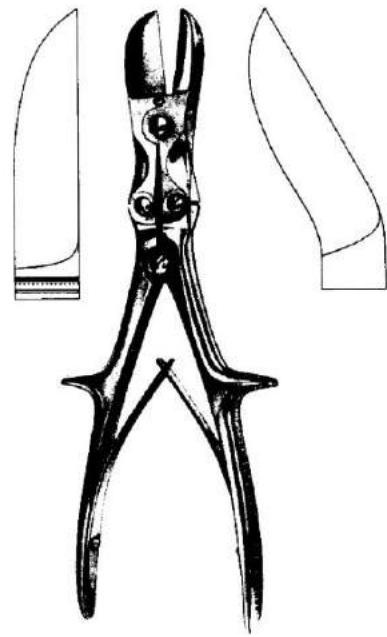

**STILLE-LISTON**

38-290-23	23 cm, 9"	38-291-23
38-290-27	27 cm, 10 1/2"	38-291-27



Bone Cutting Forceps  
Pinzas contantes para huesos



STILLE-LISTON  
38-292-26  
26 cm, 10 1/4"

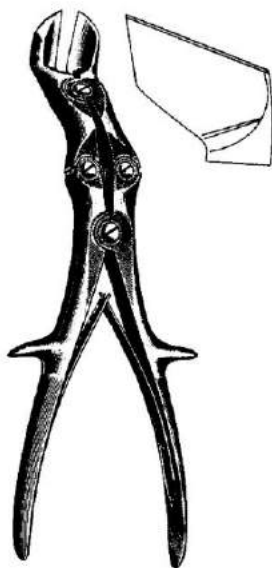

STILLE-HORSLEY  
38-293-27  
27 cm, 10 1/2"



SEMB  
38-295-24  
24 cm, 9 1/2"



Bone Holding Forceps  
Pinzas para huesos

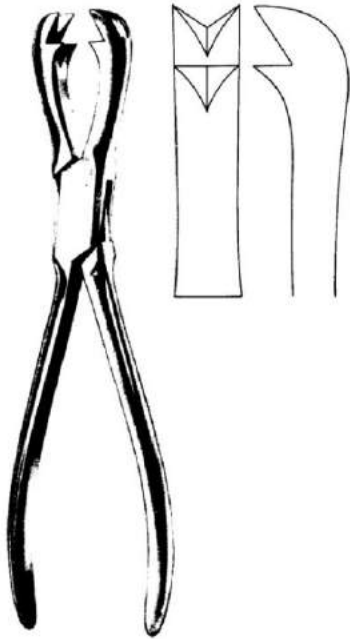

**FERGUSSON**  
38-360-21  
21 cm, 8 1/4"

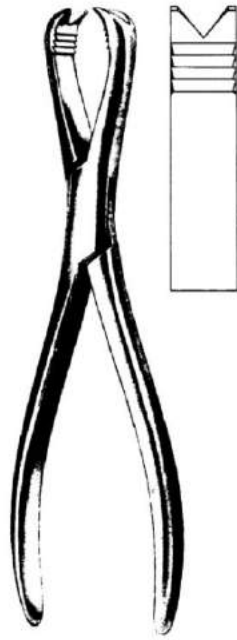

**LANGENBECK**  
38-362-21  
21 cm, 8 1/4"

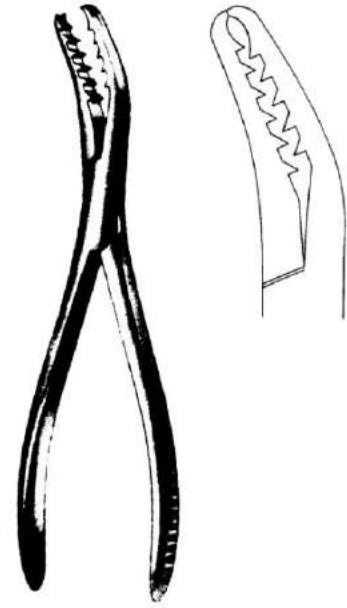

**SEMB**  
38-365-19 19 cm, 7 1/2"



**SEMB**  
38-366-19 19 cm, 7 1/2"



**FARABEUF**  
38-366-23 23 cm, 9"  
38-366-26 26 cm, 10 1/4"



**FARABEUF-LAMBOTTE**  
38-368-26  
26 cm, 10 1/4"



## Bone Holding Forceps Pinzas para huesos



LAMBOTTE  
38-370-22 22 cm, 8 3/4"  
38-370-27 27 cm, 10 1/2"  
38-370-30 30 cm, 11 3/4"

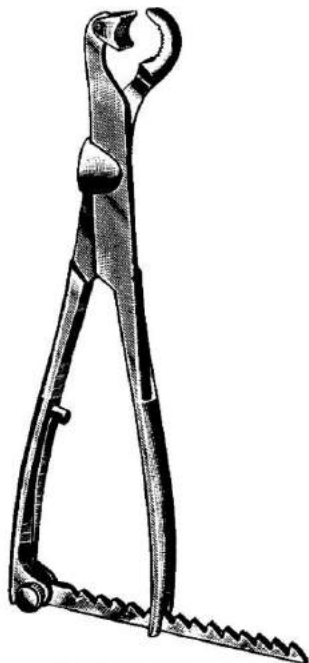

LAMBOTTE  
38-372-22 22 cm, 8 3/4"  
38-372-26 26 cm, 10 1/4"  
38-372-33 33 cm, 13"

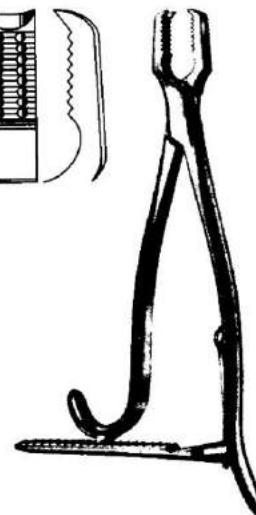
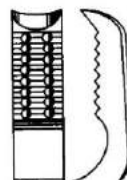

KERN  
38-378-15 15 cm, 6" 38-380-15  
38-378-17 17 cm, 6 3/4" 38-380-17  
38-378-21 21 cm, 8 1/4" 38-380-21



LANE  
38-382-33 33 cm, 13"  
38-382-45 45 cm, 17 3/4"

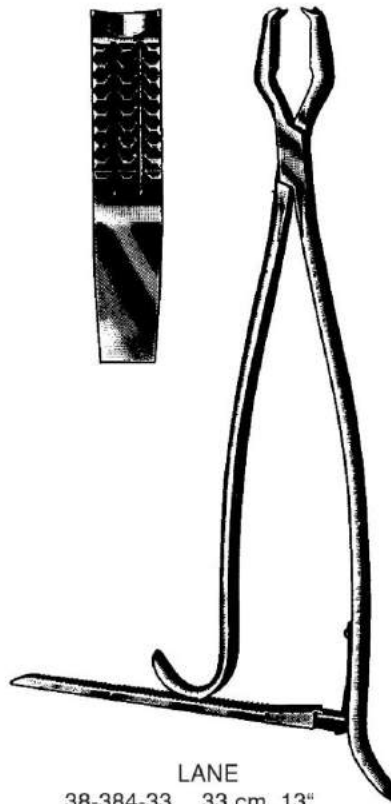

LANE  
38-384-33 33 cm, 13"  
38-384-45 45 cm, 17 3/4"



Bone Holding Forceps  
Pinzas para huesos

Self-Centering  
autocentrantes  
autocentranti



38-391-15  
15 cm, 6"

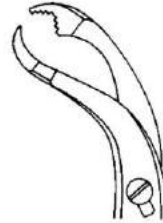

38-391-19  
19 cm, 7 1/2"

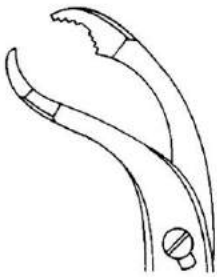

38-391-24  
24 cm, 9 1/2"

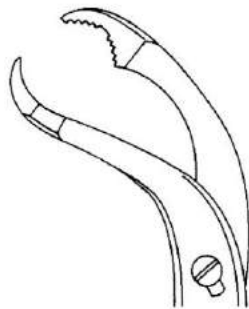

38-391-26  
26 cm, 10 1/4"

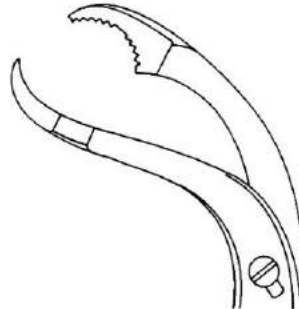

38-391-28  
28 cm, 11"

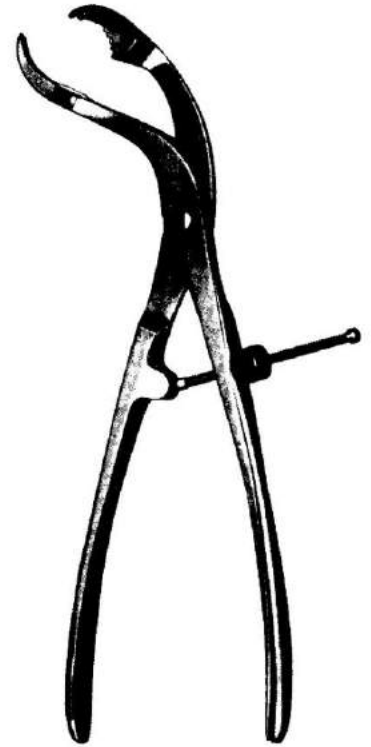

38-391-15 to 38-391-28

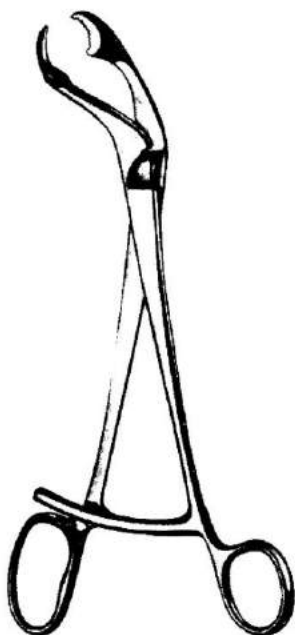

VERBRUGGE  
38-395-17 to 38-395-27



38-395-17  
17.5 cm, 7"

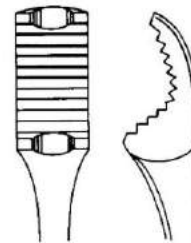

38-395-25  
25 cm, 10"

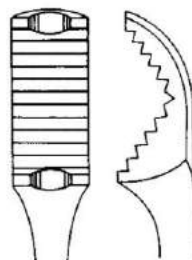

38-395-26  
26 cm, 10 1/4"

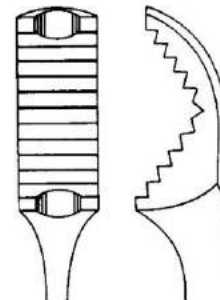

38-395-27  
27 cm, 10 1/2"

Bone Holding Forceps  
Pinzas para huesos

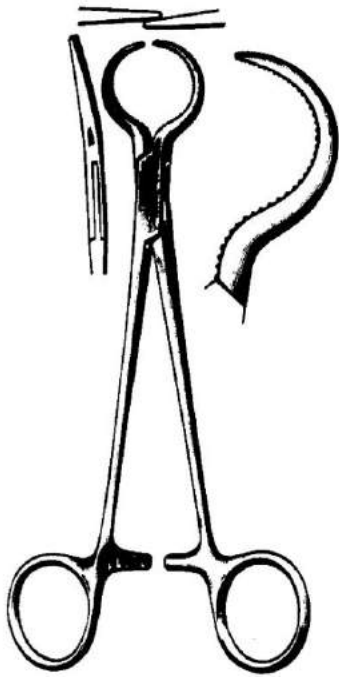

LEWIN  
38-402-17  
17.5 cm, 7"



BIRCHER-GANSKE  
38-404-20 38-405-20  
20 cm, 8"



38-406-20  
20 cm, 8"



DINGMAN  
38-407-19  
19 cm, 7 1/2"

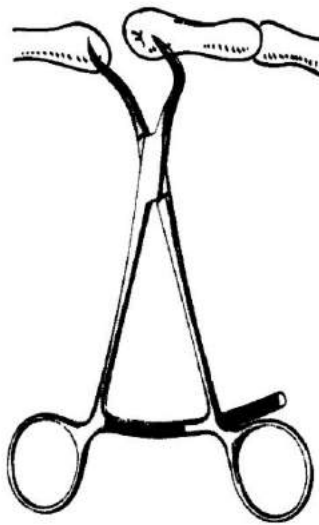

BOOTNAS  
38-409-13  
13.5 cm, 5 1/4"

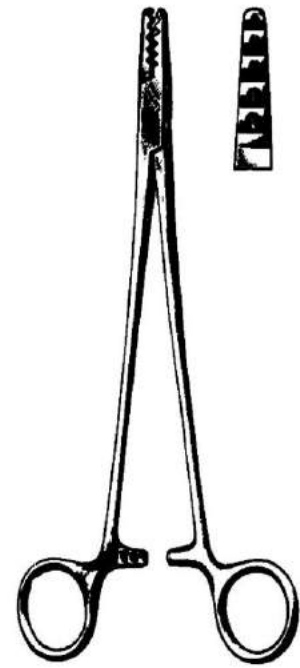

MARTIN  
38-410-19  
19 cm, 7 1/2"



Bone Holding Forceps  
Pinzas para huesos



38-412-16 or 38-412-24

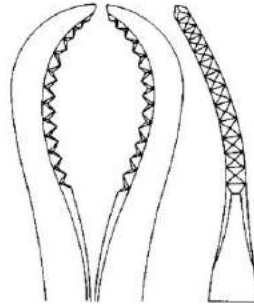

38-412-16  
16 cm, 6 1/4"

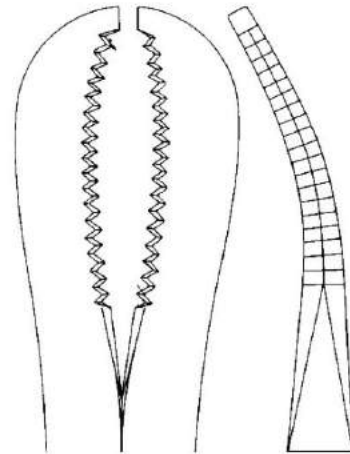

38-412-24  
24 cm, 9 1/2"

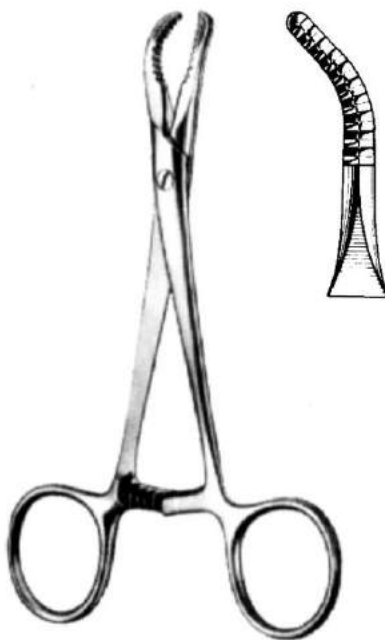

38-413-14  
13.5 cm, 5 1/4"



38-414-21  
21 cm, 8 1/4"



Bone Holding Forceps  
Pinzas para huesos



ULRICH  
38-415-23 to 38-415-28

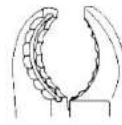
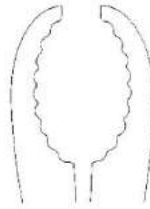

38-415-23  
23 cm, 9"

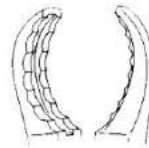

38-415-25  
25 cm, 10"

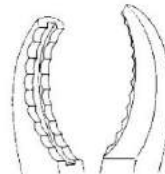

38-415-28  
28 cm, 11"

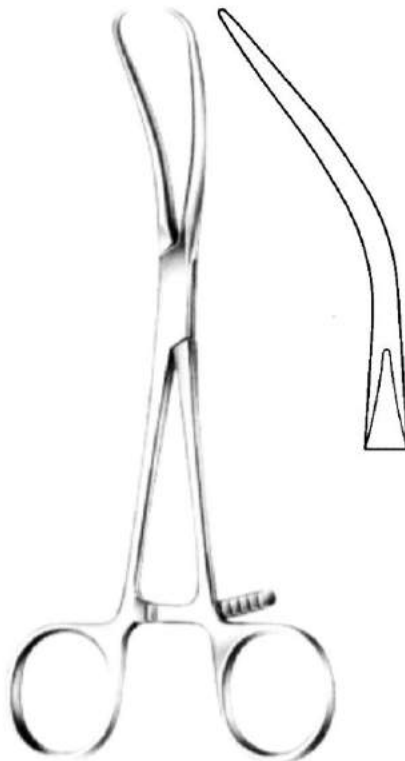

REILL  
38-416-17  
17 cm, 6 3/4"



38-417-18  
18.5 cm, 7 1/4"

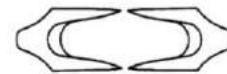





## Bone Holding Forceps, Clamps Pinzas para huesos, Clamps porta-huesos

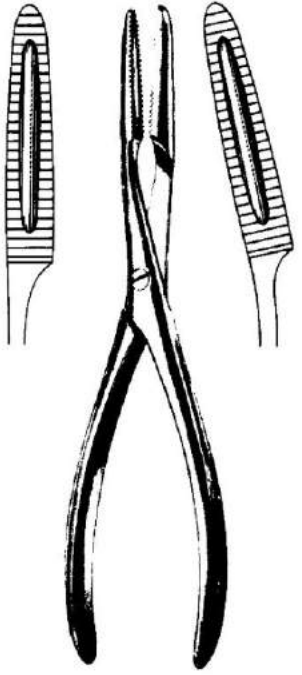

38-420-20 38-421-20  
20 cm, 8"

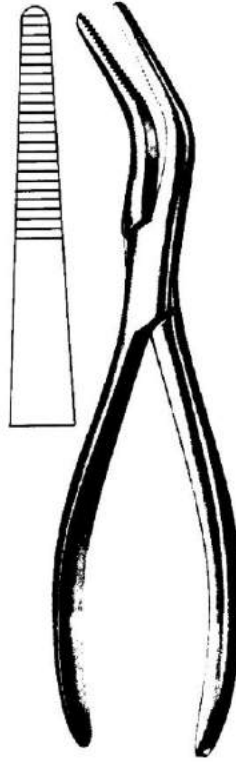

VAN BUREN  
38-423-23  
23 cm, 9"

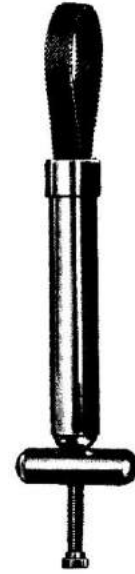

FELDHEIM  
38-424-10  
10 cm, 4"

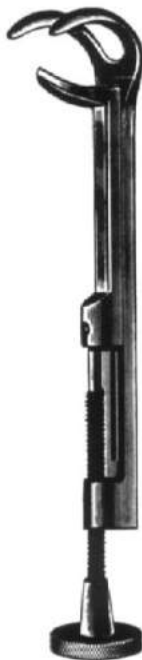

LOWMAN  
38-441-13 13 cm, 5 1/8"  
38-441-18 18 cm, 7"  
38-441-20 20 cm, 8"



LOWMAN-HOGLUND  
38-442-19  
19 cm, 7 1/2"

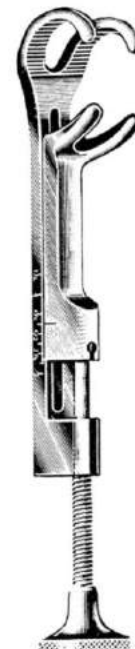

LAMBERT-LOWMAN  
38-443-18  
18 cm, 7"



Bone Traction Bar, Lead Hands  
Pinzas para huesos, Manoplas de plomo

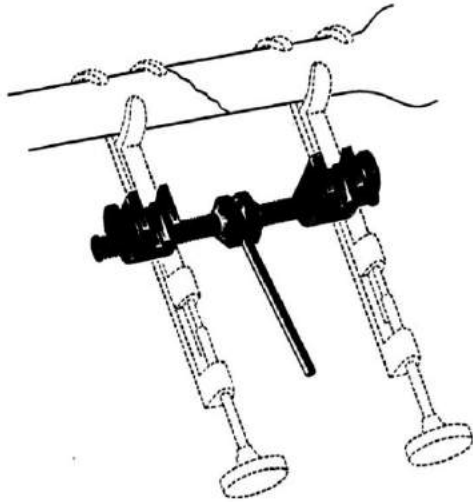

GERSTER  
38-444-15



38-446-16  
SAXENA Bone Graft Retractor  
6.5"

38-450-01  
Adult  
adultos  
adulti

38-450-02  
Child  
niños  
bambini

Bone Curettes  
Cucharillas cortantes

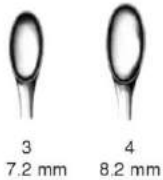
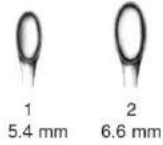

SCHEDE	Fig.	VOLKMAN
	0000	38-469-96
38-467-97	000	38-469-97
38-467-98	00	38-469-98
38-468-00	0	38-470-00
38-468-01	1	38-470-01
38-468-02	2	38-470-02
38-468-03	3	38-470-03
38-468-04	4	38-470-04
	5	38-470-05
	6	38-470-06

SCHEDE  
17 cm, 6 3/4"  
38-467-97 to 38-468-04

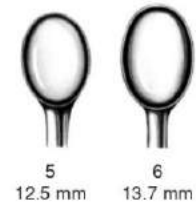
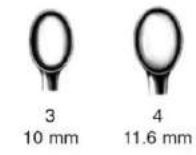

VOLKMAN  
17 cm, 6 3/4"  
38-469-96 to 38-470-06

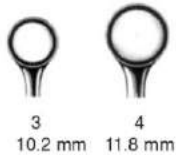

BRUNS	Fig.	SPRATT
	0000	
38-471-96	000	38-474-97
38-471-97	00	38-474-98
38-472-00	0	38-475-00
38-472-01	1	38-475-01
38-472-02	2	38-475-02
38-472-03	3	38-475-03
38-472-04	4	38-475-04
38-472-05	5	38-475-05
38-472-06	6	38-475-06

BRUNS  
17 cm, 6 3/4"  
38-471-96 to 38-472-06

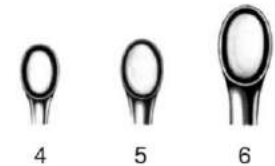

SPRATT  
17 cm, 6 3/4"  
38-474-97 to 38-475-06

Bone Currettes  
Cucharillas cortantes

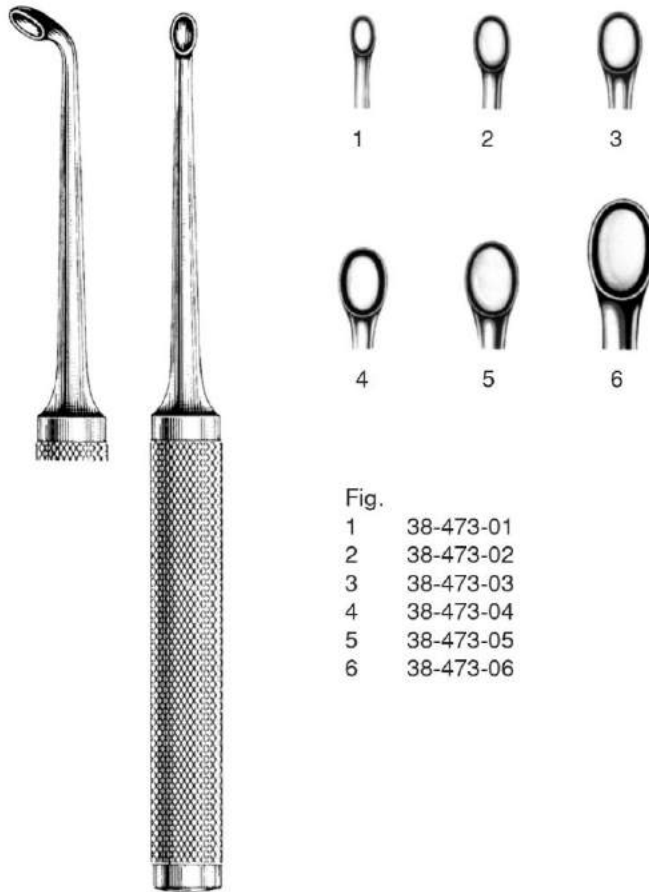

Fig.

- 1 38-473-01
- 2 38-473-02
- 3 38-473-03
- 4 38-473-04
- 5 38-473-05
- 6 38-473-06

COBB  
27.9 cm, 11"



**Bone Curettes**  
Cucharillas cortantes

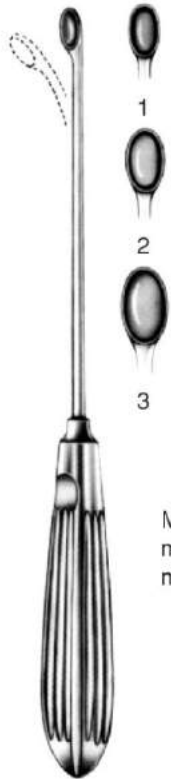

Fig.

1	38-476-01	4.8 mm
2	38-476-02	5.8 mm
3	38-476-03	6.8 mm

Malleable  
maleable  
malleabile

**HALLE**  
21 cm, 8 1/4"  
38-476-01 to 38-476-03



Fig.

000	38-476-98	2.8 mm
00	38-476-99	3.3 mm
0	38-477-00	3.7 mm
1	38-477-01	4.3 mm
2	38-477-02	4.8 mm
3	38-477-03	5.6 mm
4	38-477-04	6.1 mm
5	38-477-05	6.7 mm
6	38-477-06	8.8 mm

**SPINAL**  
20 cm, 8"  
38-476-98 to 38-477-06

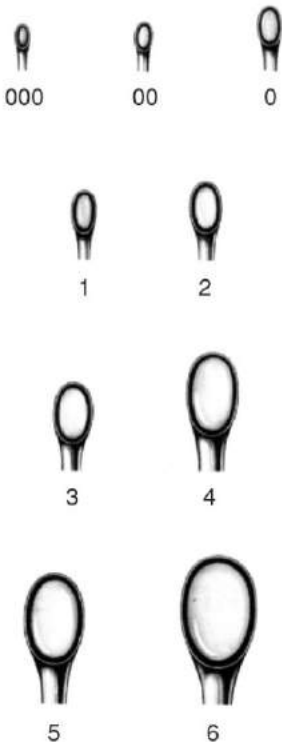

Fig.

000	38-478-98	2.8 mm
00	38-478-99	3.3 mm
0	38-479-00	3.7 mm
1	38-479-01	4.3 mm
2	38-479-02	4.8 mm
3	38-479-03	5.6 mm
4	38-479-04	6.1 mm
5	38-479-05	6.7 mm
6	38-479-06	8.8 mm

**SPINAL**  
20 cm, 8"  
38-478-98 to 38-479-06



	38-482-01	4.7 mm
	38-482-02	4.7 mm
	38-482-03	4.7 mm

**SCOVILLE**  
25 cm, 10"  
38-482-01 to 38-482-03

## Bone Currettes Cucharillas cortantes

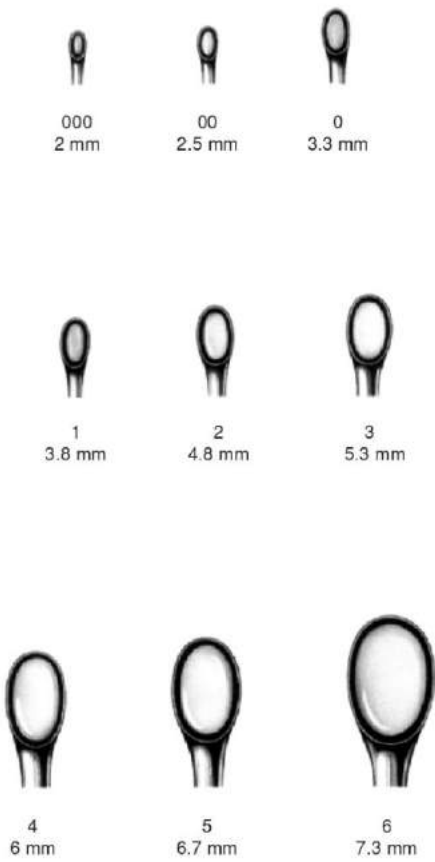

BRUNS  
23 cm, 9"



BRUNS  
23 cm, 9"



BRUNS  
23 cm, 9"

Fig.

000	38-480-97	38-482-97	2.8 mm	38-484-97	2.8 mm
00	38-480-98	38-482-98	3.3 mm	38-484-98	3.3 mm
0	38-481-00	38-483-00	3.7 mm	38-485-00	3.7 mm
1	38-481-01	38-483-01	4.3 mm	38-485-01	4.3 mm
2	38-481-02	38-483-02	4.8 mm	38-485-02	4.8 mm
3	38-481-03	38-483-03	5.6 mm	38-485-03	5.6 mm
4	38-481-04	38-483-04	6.1 mm	38-485-04	6.1 mm
5	38-481-05	38-483-05	6.7 mm	38-485-05	6.7 mm
6	38-481-06	38-483-06	8.8 mm	38-485-06	8.8 mm



**Bone Currettes**  
Cucharillas cortantes



38-485-21 21 cm, 8 1/4"  
Round/Oval  
avalado/redondo  
ovale/rotonda



WILLIGER  
17.5 cm  
7"

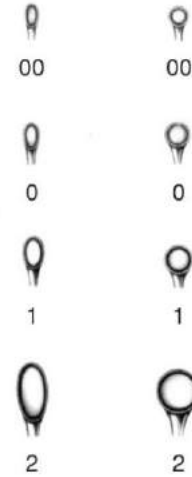
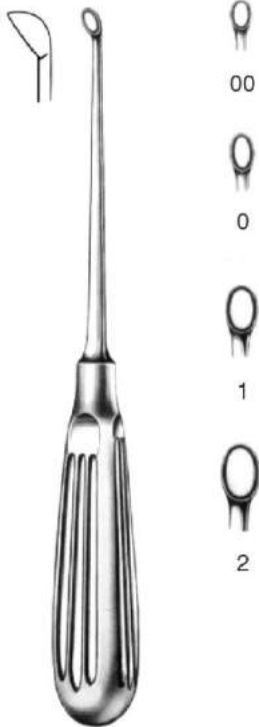

Fig. 00	38-485-99	38-486-99
0	38-486-00	38-487-00
1	38-486-01	38-487-01
2	38-486-02	38-487-02



DAUBENSPECK	Fig. 00	38-487-99
20 cm, 8"	0	38-488-00
	1	38-488-01
	2	38-488-02



27 cm	Fig. 0	38-489-00
10 1/2"	1	38-489-01
	2	38-489-02
	3	38-489-03



## Bone Currettes Cucharillas cortantes



LEMPERT  
17.5 cm, 7"



0



00



000



0000



00000

Fig. 0	38-490-10	3.3 mm
00	38-490-20	3.0 mm
000	38-490-30	2.7 mm
0000	38-490-40	2.4 mm
00000	38-490-50	2.0 mm

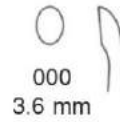

000  
3.6 mm

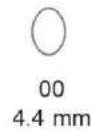

00  
4.4 mm

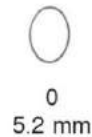

0  
5.2 mm

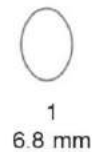

1  
6.8 mm

Fig. 000	38-491-01
00	38-491-02
0	38-491-03
1	38-491-04

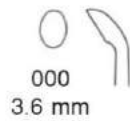

000  
3.6 mm

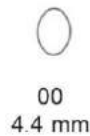

00  
4.4 mm

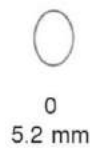

0  
5.2 mm

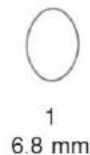

1  
6.8 mm

Fig. 000	38-491-05
00	38-491-06
0	38-491-07
1	38-491-08

BOOTNAS  
25 cm, 10"



25 cm, 10"

Fig. 000	38-500-01
00	38-500-02
0	38-500-03

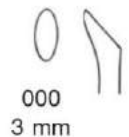

000  
3 mm



00  
4 mm



0  
5 mm



BUSHE  
25 cm, 10"





**Bone Currettes**  
Cucharillas cortantes



**VOLKMANN**  
38-492-13 13 cm, 5 1/8"  
38-492-16 16 cm, 6 1/4"  
38-492-20 20 cm, 8"



**VOLKMANN**  
38-494-13 13 cm, 5 1/8"  
38-494-14 14 cm, 5 1/2"  
38-494-17 17 cm, 6 3/4"



**JANSEN**  
38-495-16  
16 cm, 6 1/4"



**WILLIGER**  
13.5 cm, 5 1/4" Fig.  
38-496-00 00/0  
38-496-01 0/1  
38-496-12 1/2



**JACOBSON**  
13 cm, 5 1/8"  
38-497-00

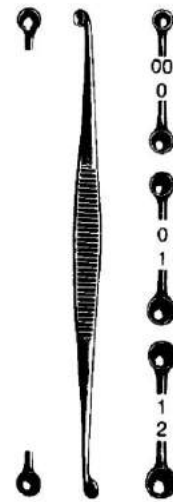



**MARTINI**  
13.5 cm, 5 1/4"  
38-498-00  
38-498-01  
38-498-12

Hemostats  
Hemostáticos



CASPAR  
20 cm, 8"

-  38-509-03  
Ø 3 mm
-  38-509-05  
Ø 5 mm
-  38-509-08  
Ø 8 mm

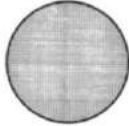
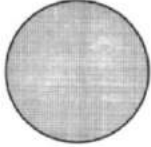
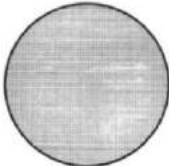

20 cm, 8"

-  38-510-12  
Ø 12 mm
-  38-510-14  
Ø 14 mm
-  38-510-16  
Ø 16 mm



## Hemostats, Chisels, Gouges Hemostáticos, Cinceles, Gubias

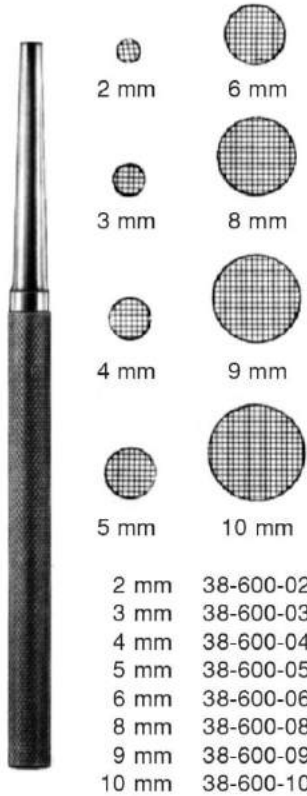

16 cm, 6 1/4"

2 mm	38-600-02
3 mm	38-600-03
4 mm	38-600-04
5 mm	38-600-05
6 mm	38-600-06
8 mm	38-600-08
9 mm	38-600-09
10 mm	38-600-10



13.5 cm, 5 1/4"

4 mm	38-602-04
6 mm	38-602-06
8 mm	38-602-08
10 mm	38-602-10
12 mm	38-602-12
14 mm	38-602-14
16 mm	38-602-16



13.5 cm, 5 1/4"

38-604-04
38-604-06
38-604-08
38-604-10
38-604-12
38-604-14
38-604-16



13.5 cm, 5 1/4"

38-605-04
38-605-06
38-605-08
38-605-10
38-605-12
38-605-14
38-605-16



ALEXANDER  
17 cm, 6 3/4"

38-610-04	4 mm
38-610-06	6 mm
38-610-08	8 mm
38-610-10	10 mm
38-610-12	12 mm
38-610-14	14 mm



ALEXANDER  
17 cm, 6 3/4"

38-611-04	4 mm
38-611-06	6 mm
38-611-08	8 mm
38-611-10	10 mm
38-611-12	12 mm
38-611-14	14 mm



PARTSCH  
13.5 cm mm 17 cm, 6 3/4"

38-620-02	2	38-622-02
38-620-03	3	38-622-03
38-620-04	4	38-622-04
38-620-05	5	38-622-05
38-620-06	6	38-622-06
38-620-07	7	38-622-07
38-620-08	8	38-622-08

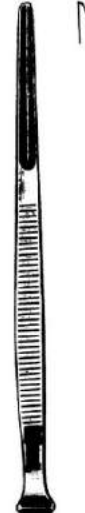

PARTSCH  
13.5 cm mm 17 cm, 6 3/4"

38-623-02	2	38-625-02
38-623-03	3	38-625-03
38-623-04	4	38-625-04
38-623-05	5	38-625-05
38-623-06	6	38-625-06
38-623-07	7	38-625-07
38-623-08	8	38-625-08



Chisels, Gouges  
Cinceles, Gubias

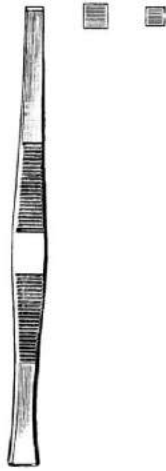

**PASSOW**  
12 cm, 4 3/4"  
38-626-35 3.5 mm  
38-626-25 2.5 mm



**BRUENINGS-LUCAS**  
16 cm, 6 1/4"  
38-627-04 4 mm  
38-627-06 6 mm



**BRUENINGS-LUCAS**  
16 cm, 6 1/4"  
38-628-03 3 mm  
38-628-05 5 mm



**STILLE**  
20 cm, 8"  
38-630-06 6 mm  
38-630-08 8 mm  
38-630-10 10 mm  
38-630-12 12 mm  
38-630-15 15 mm  
38-630-20 20 mm  
38-630-25 25 mm  
38-630-30 30 mm



**STILLE**  
20 cm, 8"

	6 mm
	8 mm
38-631-10	10 mm
38-631-12	12 mm
38-631-15	15 mm
38-631-20	20 mm
38-631-25	25 mm
38-631-30	30 mm



**STILLE**  
20 cm, 8"

38-632-06
38-632-08
38-632-10
38-632-12
38-632-15
38-632-20
38-632-25
38-632-30



**STILLE**  
20 cm, 8"

38-633-06
38-633-08
38-633-10
38-633-12
38-633-15
38-633-20
38-633-25
38-633-30



**STILLE**  
20 cm, 8"

38-634-06
38-634-08
38-634-10
38-634-12
38-634-15
38-634-20
38-634-25
38-634-30

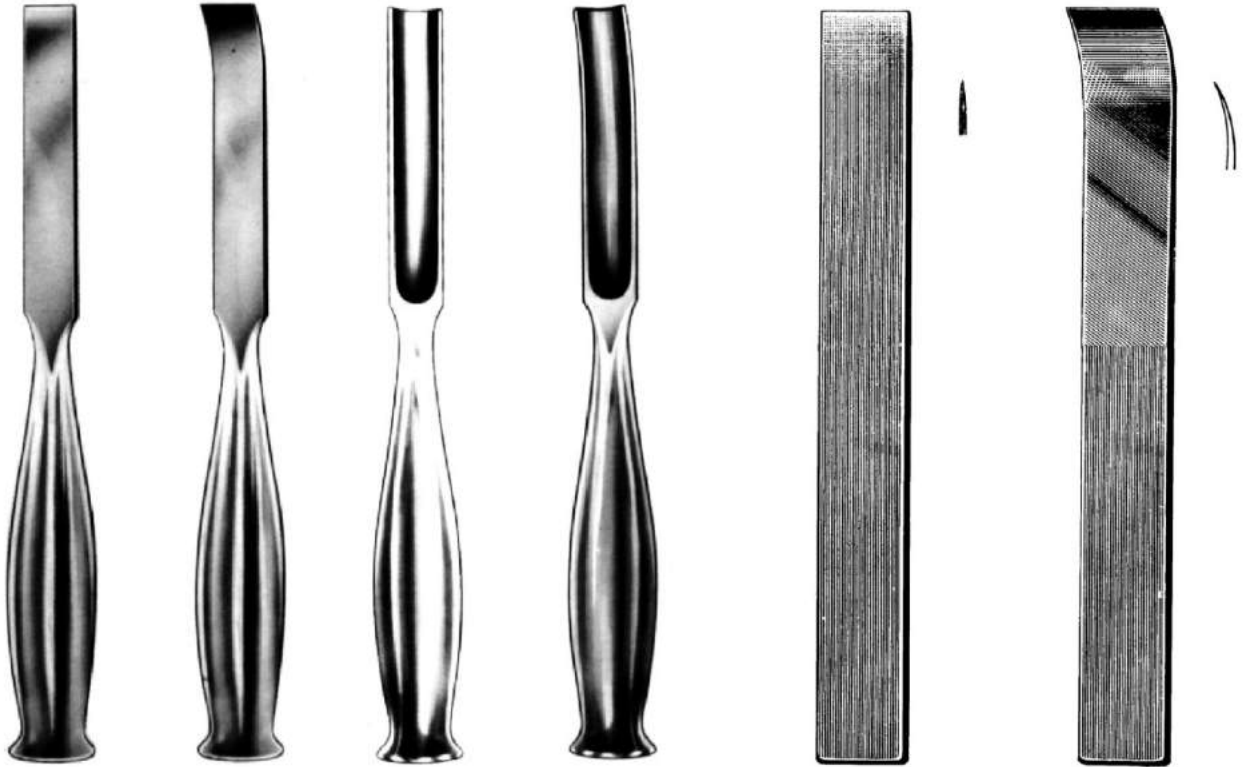

**SMITH-PETERSEN**  
20 cm, 8"

**LAMBOTTE**  
23 cm, 9"      23 cm, 9"

6 mm	38-644-06	38-645-06	38-647-06	
9 mm	38-644-09	38-645-09	38-647-09	38-649-09
13 mm	38-644-13	38-645-13		
14 mm			38-647-14	38-649-14
16 mm	38-644-16	38-645-16	38-647-16	38-649-16
19 mm	38-644-19	38-645-19	38-647-19	38-649-19
25 mm	38-644-25	38-645-25	38-647-25	38-649-25
32 mm	38-644-32	38-645-32	38-647-32	38-649-32

38-650-04	4 mm	38-651-04
38-650-06	6 mm	38-651-06
38-650-08	8 mm	38-651-08
38-650-10	10 mm	38-651-10
38-650-13	13 mm	38-651-13
38-650-16	16 mm	38-651-16
38-650-18	18 mm	38-651-18
38-650-20	20 mm	38-651-20
38-650-25	25 mm	38-651-25
38-650-30	30 mm	38-651-30
38-650-38	38 mm	38-651-38
38-650-44	44 mm	38-651-44
38-650-50	50 mm	38-651-50



Osteotomes, Gouges  
Cinceles, Gubias



MINI-LAMBOTTE (Swiss Pattern)

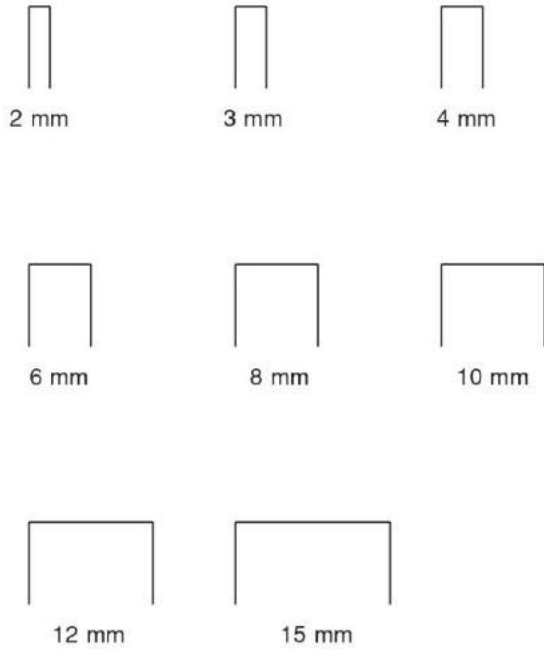

12.5 cm, 5"	mm	17 cm, 6 3/4"
38-654-02	2	38-652-02
38-654-03	3	38-652-03
38-654-04	4	38-652-04
38-654-06	6	38-652-06
38-654-08	8	38-652-08
38-654-10	10	38-652-10
38-654-12	12	38-652-12
38-654-15	15	38-652-15

Gouges with Ferrozell Handle  
Gubias con mango de Ferrozell  
Sgorbie con manico di Ferrozell

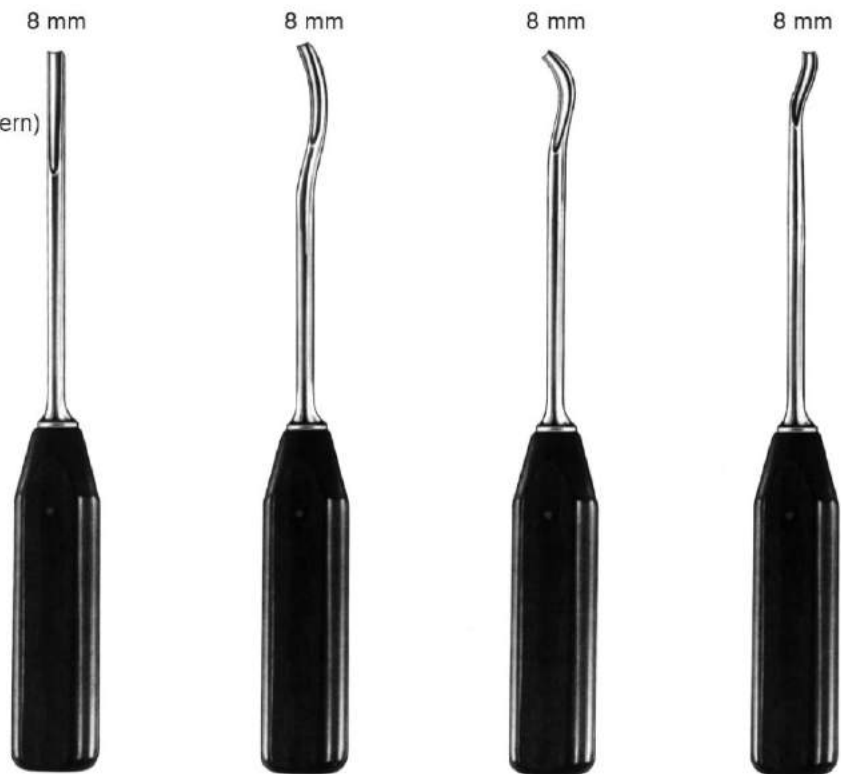

COBB  
28 cm, 11"  
38-656-28

COBB  
28 cm, 11"  
38-657-28

COBB  
28 cm, 11"  
38-658-28

COBB  
28 cm, 11"  
38-659-28



Chisels and Gouges with Ferrozell Handle  
Gubias con mango de Ferrozell



LEXER  
22 cm, 8 3/4"

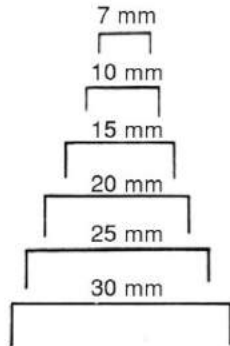

38-660-07	7 mm	38-661-07
38-660-10	10 mm	38-661-10
38-660-15	15 mm	38-661-15
38-660-20	20 mm	38-661-20
38-660-25	25 mm	38-661-25
38-660-30	30 mm	38-661-30

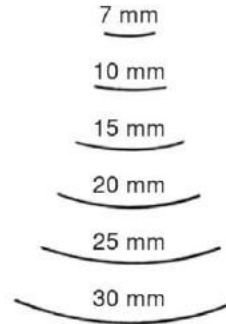

LEXER  
22 cm, 8 3/4"



LEXER Mini  
18 cm, 7"

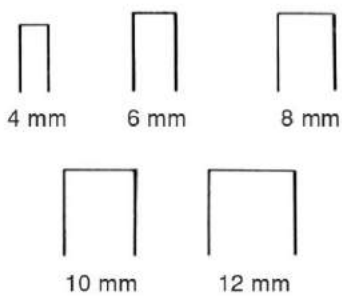

38-664-04	4 mm	38-665-04
38-664-06	6 mm	38-665-06
38-664-08	8 mm	38-665-08
38-664-10	10 mm	38-665-10
38-664-12	12 mm	38-665-12

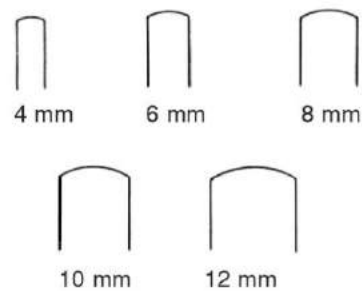

LEXER Mini  
18 cm, 7"



Chisels, Gouges  
Cinceles



20 mm

38-665-24  
24.5 cm, 9 3/4"



16 mm

38-665-26  
26.5 cm, 10 1/2"

Gouges with Novotex Handle  
Gubias con mango de Novotex  
Sgorbie con manico di Novotex



ZIELKE 23 cm, 9"  
38-665-55 5.5 mm  
38-665-90 9.0 mm



9 mm

22 cm, 8 3/4"  
38-666-22

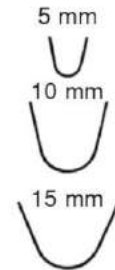

25 cm, 10"

38-669-05	5 mm	38-670-05
38-669-10	10 mm	38-670-10
38-669-15	15 mm	38-670-15





Chisels, Gouges  
Cinceles, Gubias



HOKE

14 cm, 5 1/2"

38-668-03	3 mm
38-668-05	5 mm
38-668-06	6 mm
38-668-08	8 mm
38-668-09	9 mm



HIBBS

24 cm, 9 1/2"

38-670-06	6 mm
38-670-09	9 mm
38-670-13	13 mm
38-670-16	16 mm
38-670-19	19 mm
38-670-25	25 mm
38-670-32	32 mm



HIBBS

24 cm, 9 1/2"

38-671-06	6 mm
38-671-09	9 mm
38-671-13	13 mm
38-671-16	16 mm
38-671-19	19 mm
38-671-25	25 mm
38-671-32	32 mm



HIBBS

24 cm, 9 1/2"

38-672-06	6 mm
38-672-09	9 mm
38-672-13	13 mm
38-672-16	16 mm
38-672-19	19 mm
38-672-25	25 mm
38-672-32	32 mm



HIBBS

24 cm, 9 1/2"

38-673-06	6 mm
38-673-09	9 mm
38-673-13	13 mm
38-673-16	16 mm
38-673-19	19 mm
38-673-25	25 mm
38-673-32	32 mm



HIBBS

24 cm, 9 1/2"

38-675-06	6 mm
38-675-09	9 mm
38-675-13	13 mm
38-675-16	16 mm
38-675-19	19 mm
38-675-25	25 mm
38-675-32	32 mm



## Chisels, Osteotomes Cinceles



38-676-01  
18.5 cm, 7 1/4"  
Handle Only  
Mango suelto  
Manico solo

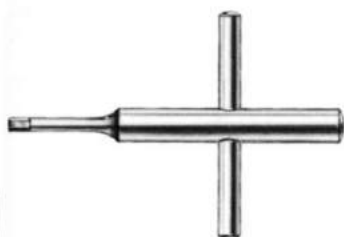

Key for Blades  
38-676-02  
9 cm, 3.5"



5 mm  
38-676-05  
8.5 mm, 3.4"



10 mm  
38-676-10  
8.5 mm, 3.4"



16 mm  
38-676-16  
8.5 mm, 3.4"



25 mm  
38-676-25  
8.5 mm, 3.4"

Chisel Blades  
Interchangeable  
Hojas de cincel  
intercambiables  
Lame intercambiabili



5 mm  
38-677-05  
8.5 mm, 3.4"



10 mm  
38-677-10  
8.5 mm, 3.4"



16 mm  
38-677-16  
8.5 mm, 3.4"



25 mm  
38-677-25  
8.5 mm, 3.4"

Osteotome Blades  
Interchangeable  
Hojas de osteótomo  
intercambiables  
Lame per osteotomia  
intercambiabili



Skull Breaker, Rachiotome, Sternum Chisel, Osteotome, Muscle Hooks  
Cinzel rompe-cráneo, Raquiótomos, Cinceles de esternón, Osteotomo, Ganchos musculares



38-680-22  
14 cm, 5 1/2"



38-682-22  
22 cm, 8 3/4"



LEBSCHE  
38-678-24  
24.5 cm, 9 3/4"



38-679-13  
13 cm, 5 1/8"



24-902-10  
10 cm, 4"



24-903-00



Chisels, Post Mortem Needles  
Cinceles, Agujas para autopsia



90-146-20 20 cc  
110 x 20 mm

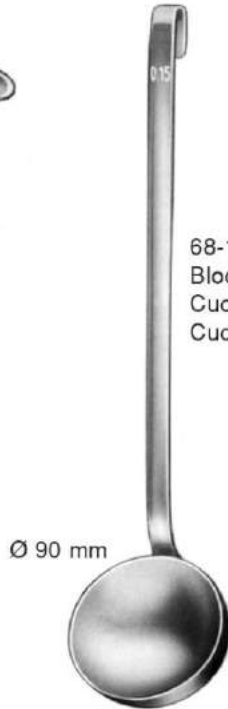

68-174-00  
Blood Scoop, 9 Cubic Inches  
Cucharra p / sangre  
Cucchiaio per sangue

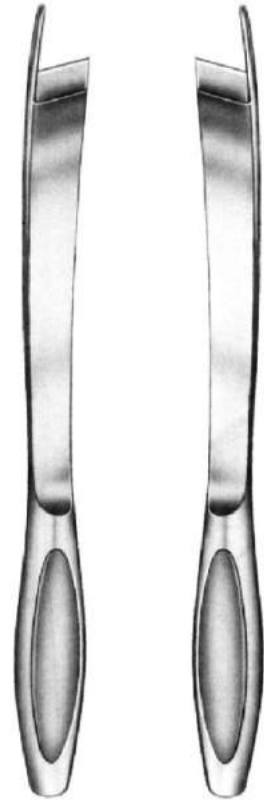

BRUNETTI  
28.5 cm, 11 1/4"  
38-682-01 38-682-02  
Left Right  
izquierdo derecho  
sinistra destra

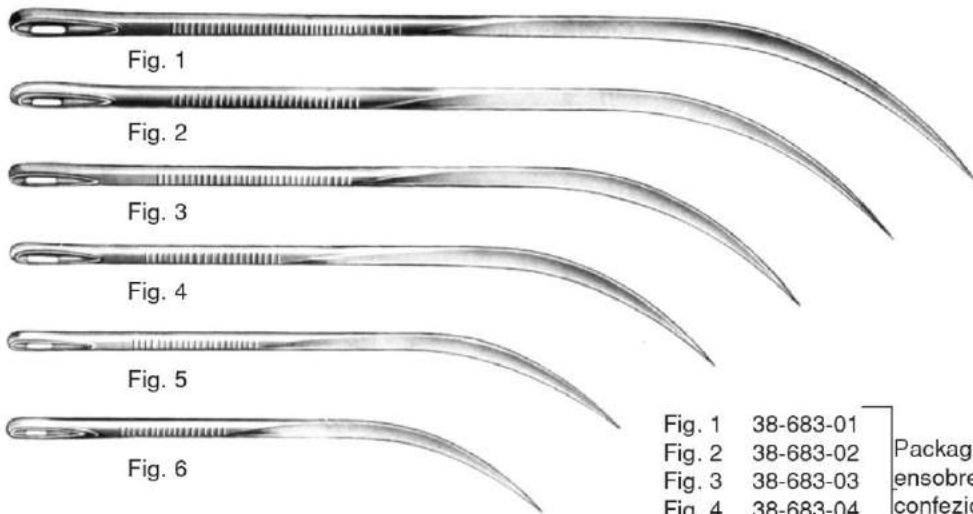

Fig. 1	38-683-01	} Package of 12 ensobres de 12 confezione di 12
Fig. 2	38-683-02	
Fig. 3	38-683-03	
Fig. 4	38-683-04	
Fig. 5	38-683-05	
Fig. 6	38-683-06	



38-684-00

Small Set in Wooden Case, consisting of:

- 4 Dissecting Knives
- 1 Cartilage Knife
- 1 Incision Scissors, 13 cm, 5 1/8"
- 1 Dissecting Forceps, 13 cm, 5 1/8"
- 1 CHARRIERE Amputation Saw
- 1 Mallet
- 1 Chisel
- 2 Retractors, Double Ended
- 2 Blow pipes, Double
- 2 Probes, 13 cm, 5 1/8"
- 3 Suture Needles

Modelo pequeño, estuche de madera, conteniendo:

- 4 Escalpelos
- 1 Cuchillo para cartilago
- 1 Tijera de incision, 13 cm (5 1/8")
- 1 Pinza para disección, 13 cm (5 1/8")
- 1 Sierra de amputación Charrière
- 1 Martillo
- 1 Escoplo
- 2 Separadores de 2 garfios, dobles
- 2 Tubos insufladores, dobles
- 2 Estiletos olivares, 13 cm (5 1/8")
- 3 Agujas para sutura

Modelo piccolo, astuccio di legno, composto da:

- 4 Bisturi
- 1 Coltello per cartilagine
- 1 Forbice per incisione, 13 cm (5 1/8")
- 1 Pinza anatomica, 13 cm (5 1/8")
- 1 Sega per amputazione, Charrière
- 1 Martello
- 1 Scalpello
- 2 Divaricatori con 2 ganci, doppi
- 2 Tubi inalatori, doppi
- 2 Specilli bottonuti, doppi, 13 cm (5 1/8")
- 3 Aghi per sutura



## Bone Hammers and Mallets Martillos y mazos

1 Ounce = 28.35 grams

Ø 25 mm



**GERZOG**  
18 cm, 7"  
38-686-25 250 grams

Ø 38 mm



**KIRK**  
19 cm, 7 1/2"  
38-687-75 750 grams

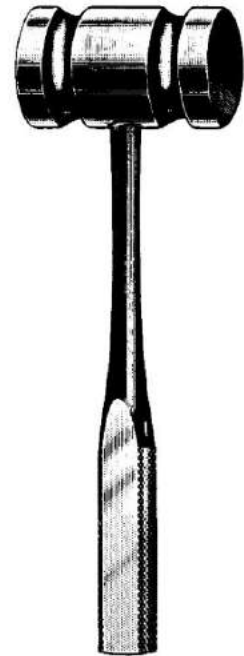

**KAMBO**  
26.5 cm, 10 1/2"  
38-688-45 450 grams  
38-689-90 900 grams

Ø 30 mm



**COLLIN**  
20 cm, 8"  
38-690-22 220 grams

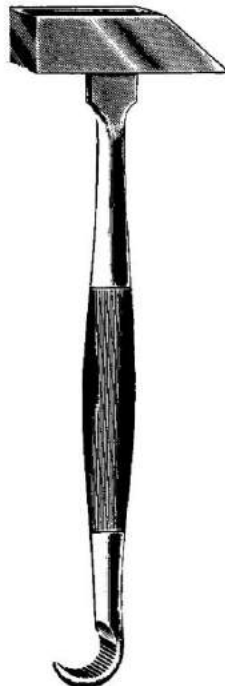

**POST MORTEM**  
38-699-00  
23.5 cm, 9 1/4"  
480 grams

Ø 25 mm



**BOOTNAS**  
38-694-01  
18 cm, 7"  
38-694-03 Nylon Caps Only



1 Ounce = 28.34 grams

## Bone Hammers and Mallets Martillos y mazos



**WILLIGER**  
24 cm, 9 1/2"  
38-691-34 340 g



**LUCAE**  
19 cm, 7 1/2"  
38-692-26 260 g



**MEAD**  
17 cm, 6 3/4"  
38-693-32 320 g

38-693-33  
Nylon Caps Only  
par de tapas de repuesto  
Coppia di placche di ricambio

38-693-34  
Metal Rings Only  
juego de anillos  
Set anelli

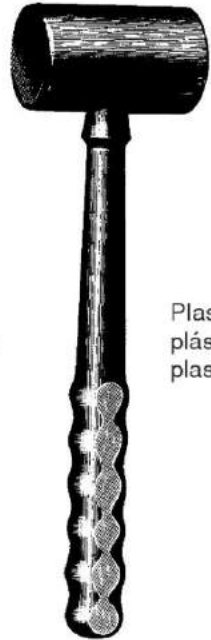

26 cm, 10 1/4"  
38-695-40 400 grams

Plastic  
plástico  
plastica



**QUISLING**  
38-696-75



**PARTSCH**  
38-698-98  
18 cm, 7"  
200 grams



**VAMMI**  
38-699-17  
26.5 cm, 10 1/2"



## Bone Hammers and Mallets Martillos y mazos

1 Ounce = 28.35 grams

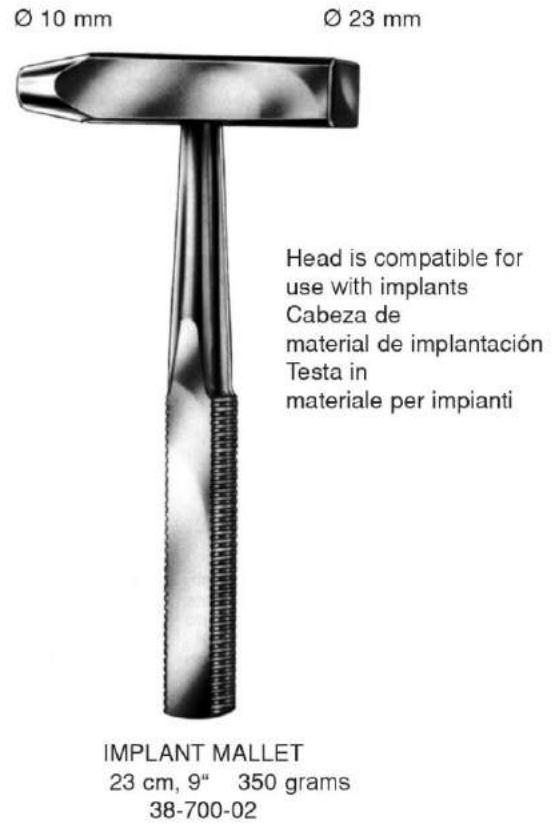





1 Ounce = 28.35 grams

## Bone Hammers and Mallets Martillos y mazos

Ø 30 mm



**COTTLE**  
18 cm, 7" 240 grams  
38-700-05

Ø 40 mm



**HEATH**  
18 cm, 7" 700 grams  
38-700-06

Ø 40 mm



**OMBREDANNE**  
25 cm, 10" 700 grams  
38-700-07

Ø 27 mm



**HAJEK**  
21 cm, 8 1/4" 140 grams  
38-700-08



## Periosteal Elevators Periostótomos

12.5 mm



**FARABEUF**  
38-702-15  
15 cm, 6"

12.5 mm



**FARABEUF**  
38-703-15  
15 cm, 6"

11 mm

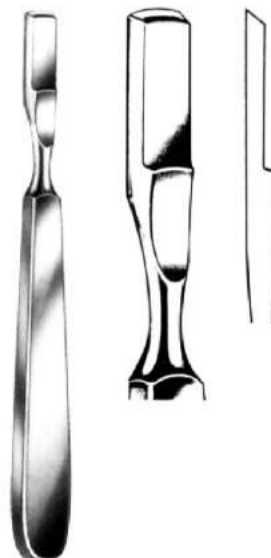

**FARABEUF-COLLIN**  
38-704-01  
15 cm, 6"

11 mm

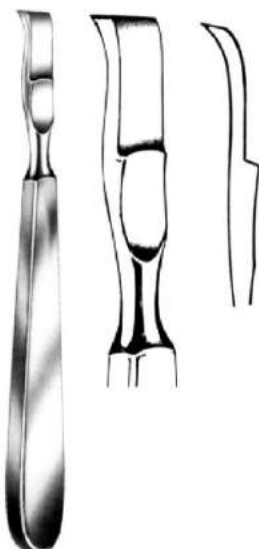

**FARABEUF-COLLIN**  
38-704-02  
15.5 cm, 6"



**LAMBOTTE**  
21 cm, 8 1/4"  
38-705-05 5 mm  
38-705-10 10 mm  
38-705-15 15 mm  
38-705-20 20 mm  
38-705-25 25 mm

18 mm



**SEDILLOT**  
18 cm, 7"  
38-706-18



Periosteal Elevators  
Periostótomos

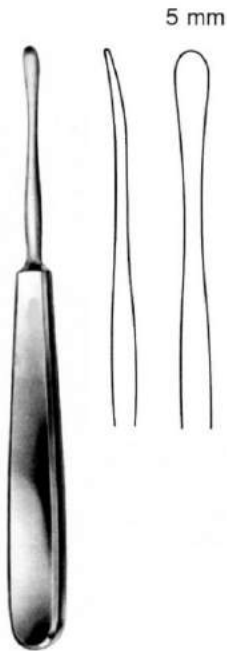

**SEBILEAU**  
17.5 cm, 7"  
38-707-17

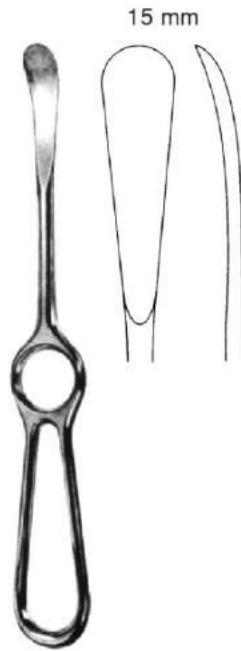

**SEDILLOT**  
21 cm, 8 1/4"  
38-709-21

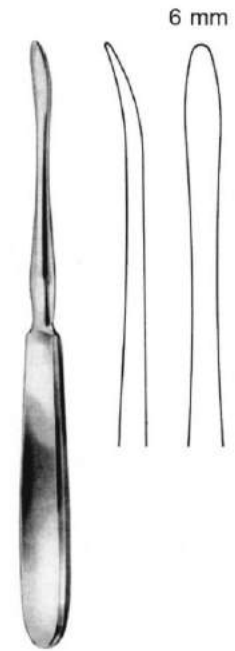

**QUERVAIN**  
19.5 cm, 7 3/4"  
38-708-19



**LANGENBECK**  
19 cm, 7 1/2"  
38-710-19



**LANGENBECK**  
18 cm, 7"  
38-711-18



**LANGENBECK**  
20 cm, 8"  
38-711-20 8 mm  
38-711-21 10 mm



Raspatories, Elevators  
Periostótomos, Elevadores

4 mm



WILLIGER  
38-711-16  
16 cm, 6 1/4"

6.5 mm



WILLIGER  
38-712-16  
16 cm, 6 1/4"

5 mm



WILLIGER  
38-713-16  
16 cm, 6 1/4"

5.5 mm



WILLIGER  
38-713-17  
17 cm, 6 3/4"

5 mm

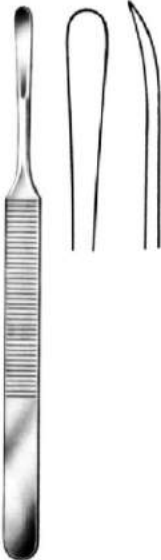

KOENIG  
38-714-15  
15.5 cm, 6"

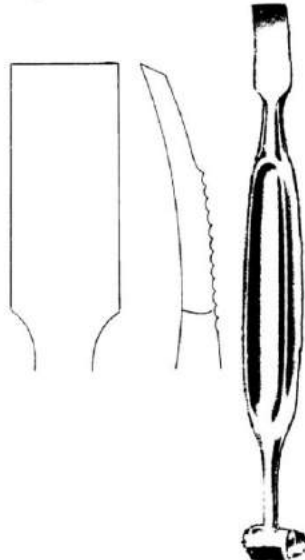

ALEXANDER  
38-715-20  
20 cm, 8"



MOLT  
38-716-18  
18 cm, 7"



## Raspatories, Elevators Periostótomos, Elevadores

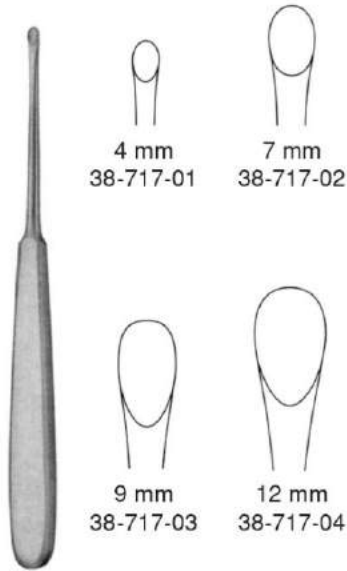

**WIBERG**  
17 cm 6 3/4"

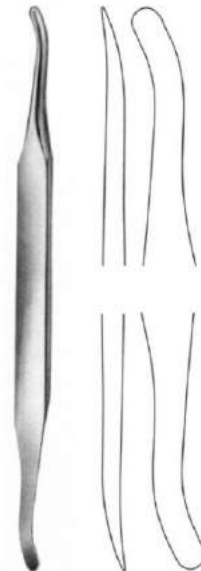

**SELDIN**  
38-722-01  
19.5 cm 7 3/4"

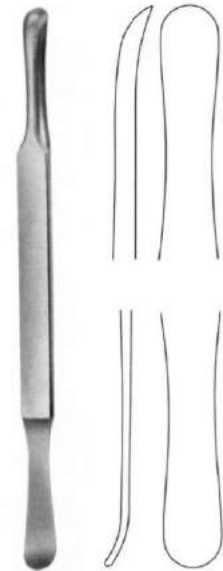

**SELDIN**  
38-722-02  
19.5 cm 7 3/4"



**JOSEPH**  
38-718-16  
16 cm, 6 1/4"



**FOMON**  
38-719-17  
17 cm, 6 3/4"



**BOIES**  
38-720-19  
19 cm, 7 1/2"



**GORNEY**  
38-720-21  
21 cm, 8 1/4"



Periosteal Elevators  
Periostótomos, Elevadores

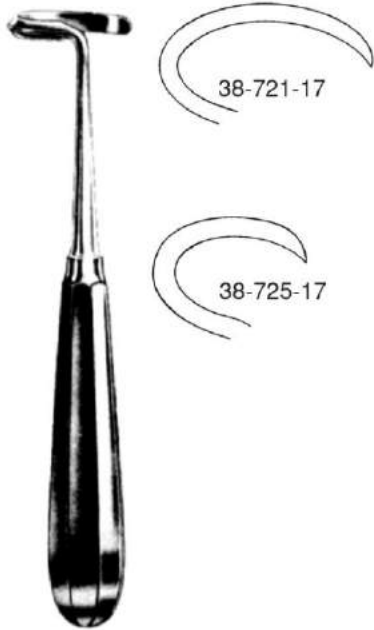

DOYEN  
17 cm  
38-721-17 Adult  
38-725-17 Child

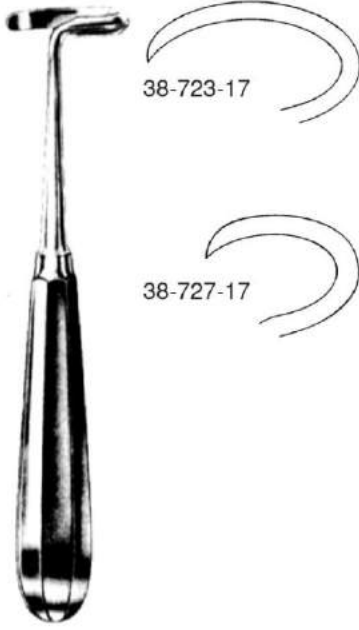

DOYEN  
17 cm  
38-723-17 Adult  
38-727-17 Child



DOYEN  
38-728-24 38-729-24  
24 cm, 9 1/2"



SEMB  
38-729-01 to  
38-729-07



38-729-01  
18 cm  
7"



38-729-02  
21 cm  
8 1/4"



38-729-03  
18 cm  
7"



38-729-04  
21 cm  
8 1/4"



38-729-05  
20 cm  
8"



38-729-06  
20 cm  
8"

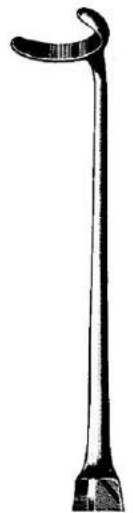

38-729-07  
23 cm  
9"



Elevators, Raspatories  
Elevadores, Periostótomos

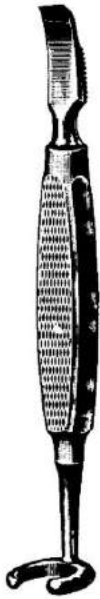

**MATSON-ALEXANDER**  
38-731-22



**MATSON**  
38-733-22  
22 cm, 8 3/4"



**OVERHOLT**  
38-735-29  
29.5 cm, 11 1/2"



**OVERHOLT**  
38-737-29  
29.5 cm, 11 1/2"



**OVERHOLT**  
38-739-28  
28.5 cm, 11 1/4"



**38-740-19**  
19 cm, 7 1/2"



**38-741-18**  
18.5 cm, 7 1/4"



**38-742-18**  
18.5 cm, 7 1/4"



**38-743-18**  
18.5 cm, 7 1/4"

Elevators, Raspatories  
Elevadores, Periostótomos

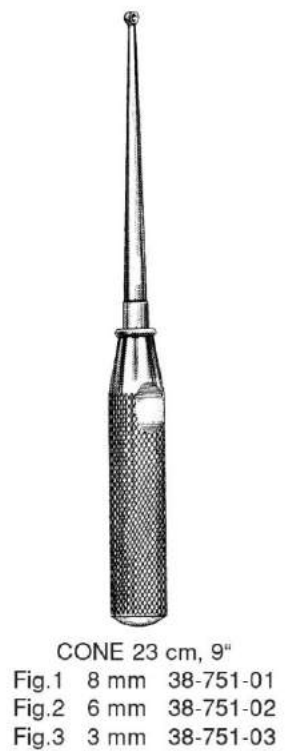
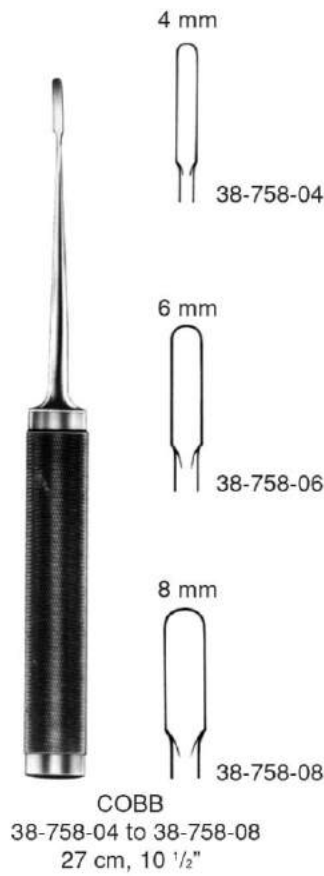
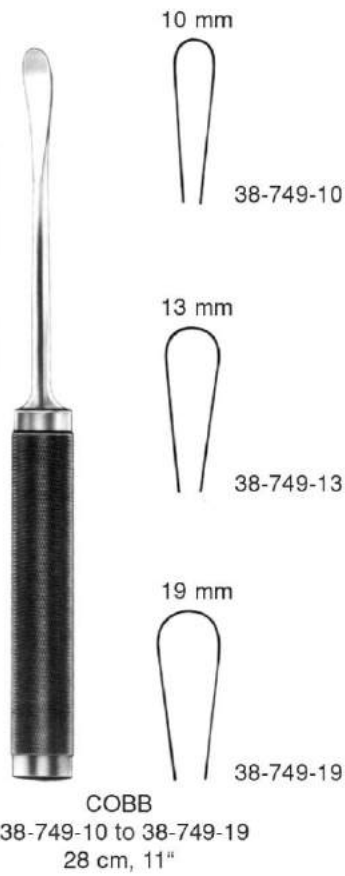
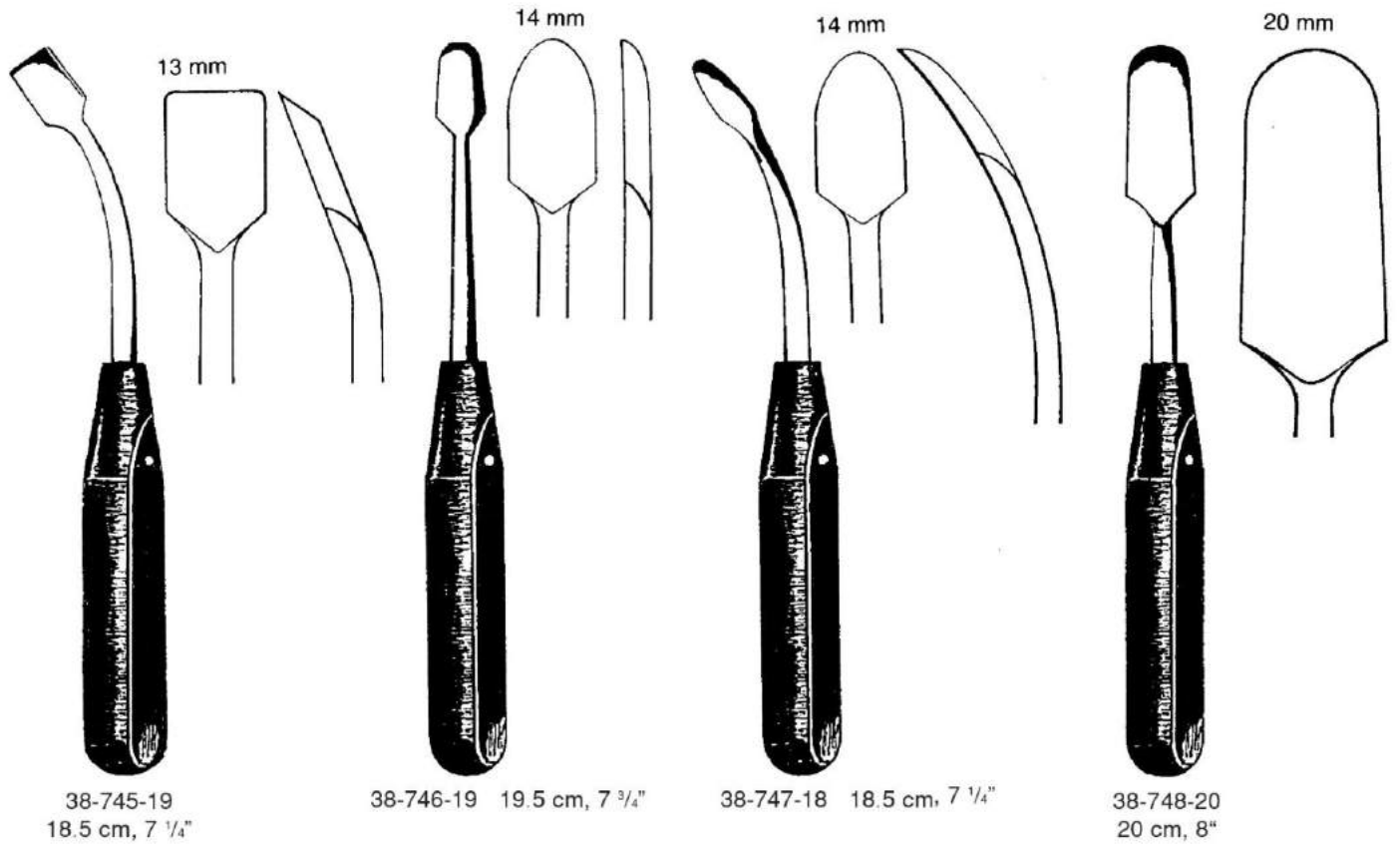





Mc Glamery Elevators

38-754-09

38-754-11

38-754-13

38-754-15

38-754-17

Sharp  
cortante  
tagliente



SAYRE  
17 cm, 6 3/4"  
38-758-01

Blunt  
romo  
smusso



SAYRE  
17 cm, 6 3/4"  
38-758-02



## Elevators, Bone Levers Elevadores para huesos

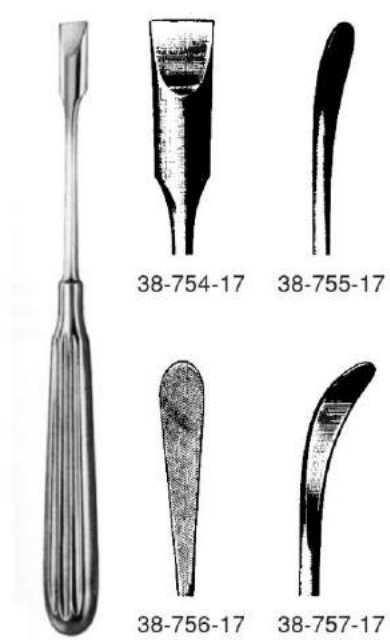

**ADSON**  
17 cm, 6 3/4"

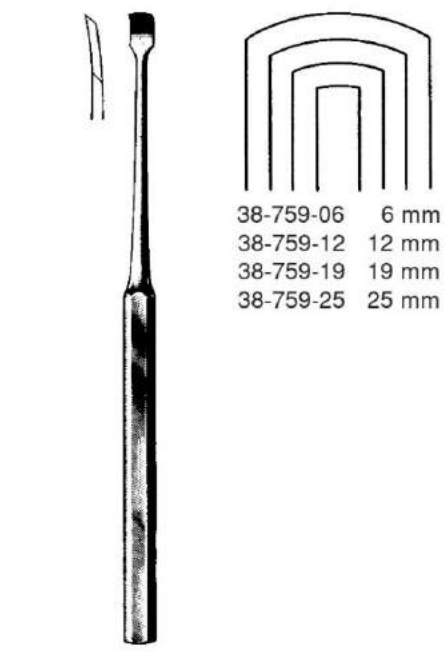

**KEY**  
38-759-06 to 38-759-25  
19 cm, 7 1/2"



**CHANDLER**  
38-763-01 19.0 cm 7 1/2"  
38-763-02 20.3 cm 8"  
38-763-03 22.9 cm 9"  
38-763-04 25.4 cm 10"

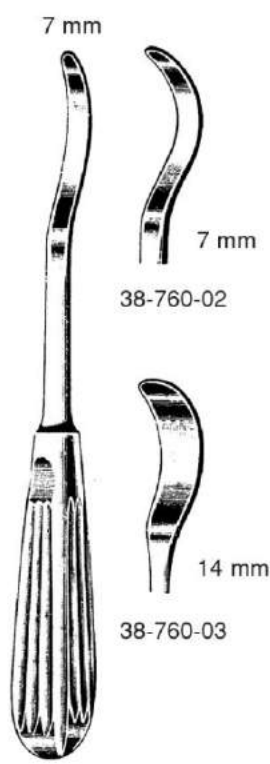

**CREGO**  
38-760-01  
20 cm, 8"



**ALDERDYCE**  
38-761-21  
21 cm, 8 1/4"



Elevators, Bone Levers  
Elevadores para huesos



WATSON-CHEYNE  
38-765-17  
17.5 cm, 7"



McDONALD  
38-767-19  
19 cm, 7 1/2"



MURPHY-LANE  
38-769-30  
30 cm, 11 3/4"



BENNETT  
38-771-71  
45 x 260 mm

BENNETT  
38-771-73  
65 x 260 mm



Bone Levers  
Elevadores para huesos



HOHMANN  
38-801-08 8 mm  
38-801-12 12 mm

HOHMANN  
38-801-18  
18 mm, 3/4"

HOHMANN  
38-801-43  
43 mm, 1 3/4"

HOHMANN  
38-801-70  
70 mm, 2 3/4"

4.5 mm



KOENIG  
38-802-01  
15 cm, 6"

4.5 mm



KOENIG  
38-802-02  
15 cm, 6"

2.8 mm



38-802-14  
14 cm, 5 1/2"

5 mm

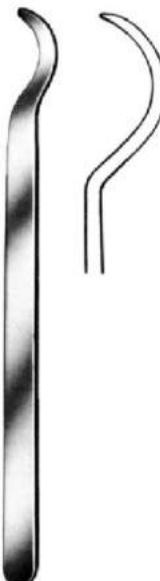

38-803-05  
15 cm, 6"

7 mm



38-803-07  
15 cm, 6"



**Bone Levers  
Elevadores para huesos**



**HOHMANN**  
38-803-43  
43 mm

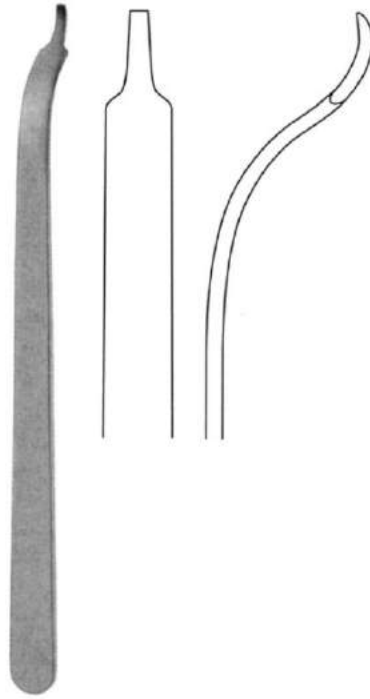

**BUCK-GRAMCKO**  
38-804-15  
15 mm



**HOHMANN**  
38-805-22  
22 mm



**HOHMANN**  
38-805-33  
33 mm



**HOHMANN**  
38-807-24  
24 mm



**HOHMANN**  
38-809-22  
22 mm



Bone Levers  
Elevadores para huesos

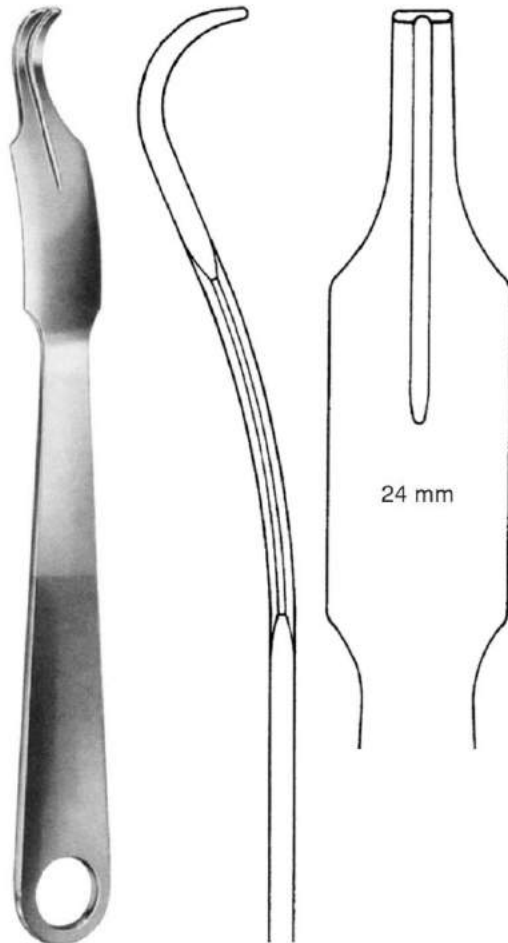

LANGE-HOHMANN  
38-810-24  
25 cm, 10"



Mini HOHMANN  
16 cm, 6 1/4"



38-811-06



38-811-08

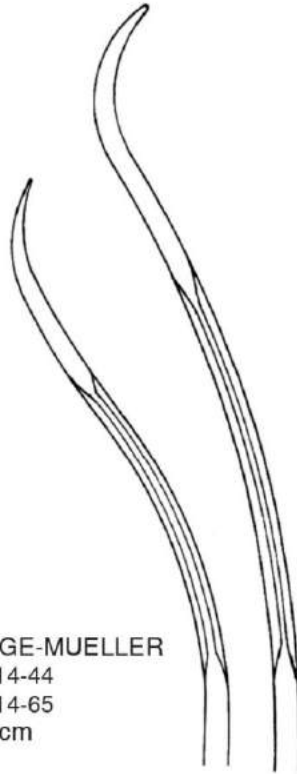

VERBRUGGE-MUELLER  
38-814-44  
38-814-65  
24 cm

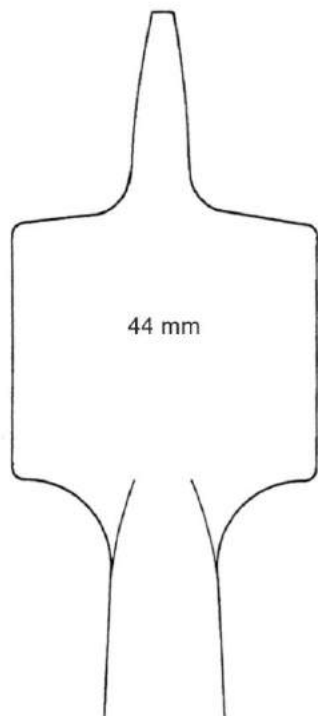

44 mm

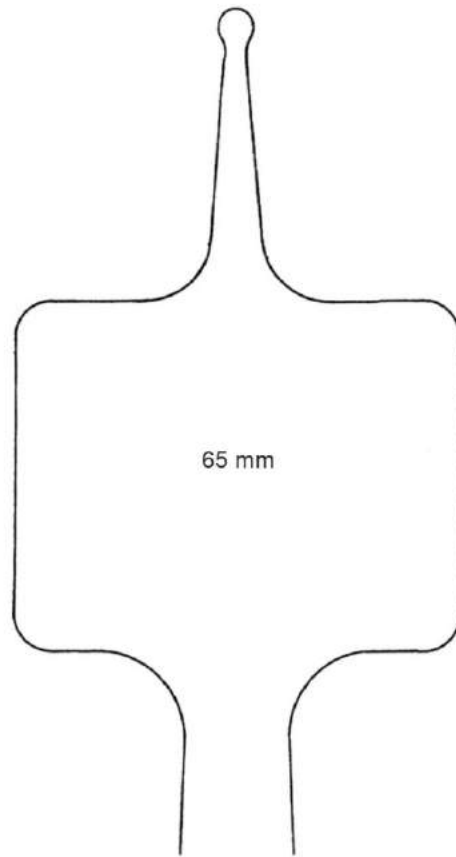

65 mm



Bone Levers  
Elevadores para huesos



BLOUNT  
38-823-26  
26 cm, 10 1/4"

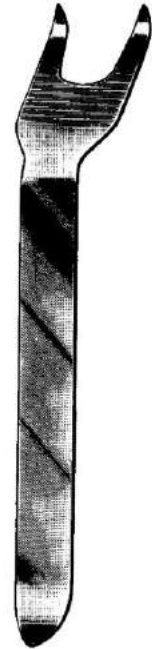

BLOUNT  
38-825-26  
26 cm, 10 1/4"

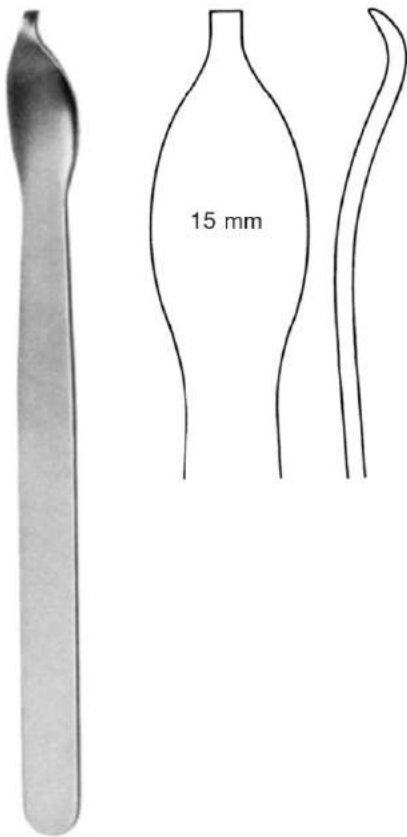

38-812-16  
16 cm, 6 1/4"

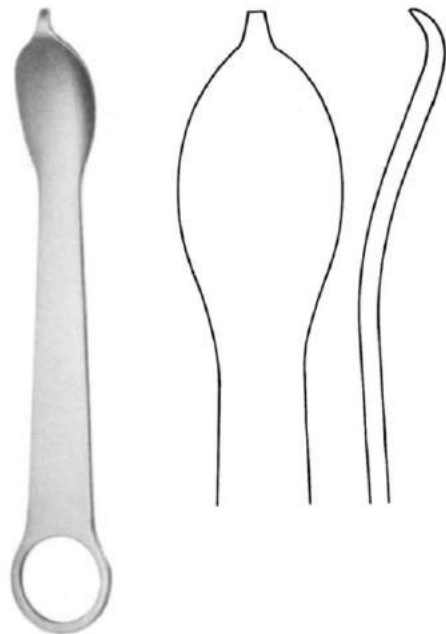

38-813-12  
12 cm, 4 3/4"





## Bone Levers, Meniscus Retractors Elevadores p. huesos, Separadores para menisco

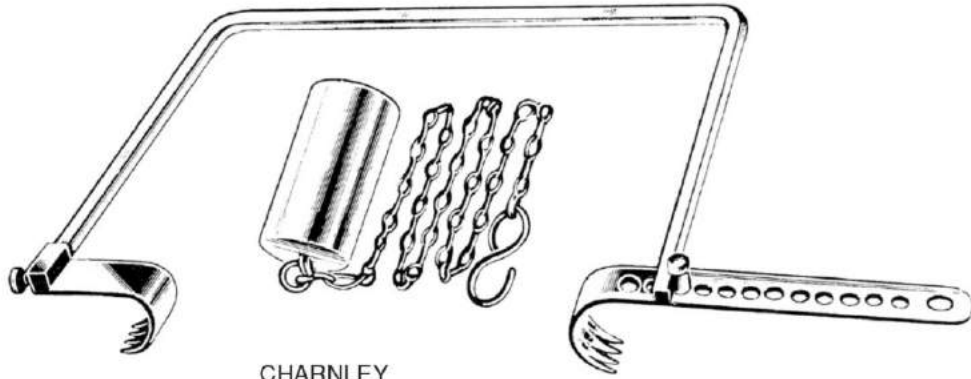

CHARNLEY  
38-826-00

38-826-01 Pointed Tip, Serrated  
puntiagula, dentada  
punta acuta, zigrinata

38-826-02 Blunt Tip, Serrated  
punta roma, dentada  
punta smussa, zigrinata

38-826-03 Blunt Tip, Smooth  
punta roma, lisa  
punta smussa, liscia



AUFRANC  
26 cm, 10 1/4"

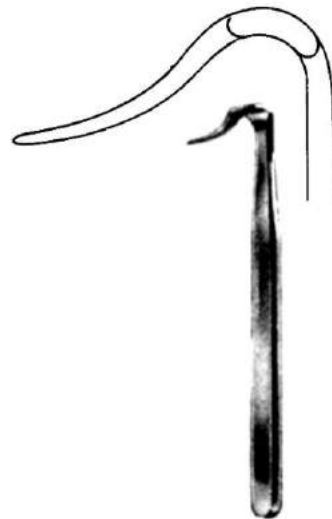

BLOUNT  
38-827-17  
17.5 cm 7"

Bone Levers, Rasp  
Elevadores p. huesos



LANE-TRETHOWAN  
38-828-21  
21.5 cm 8 1/2"

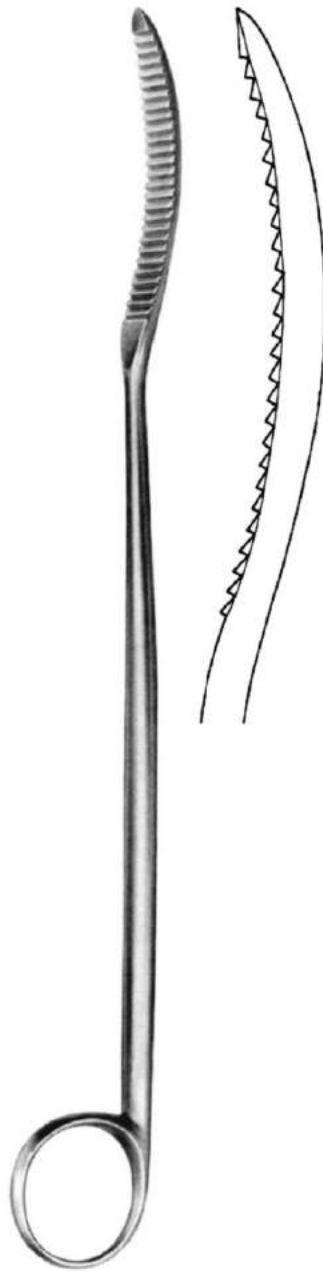

LANE  
38-829-25  
25.5 cm 10"

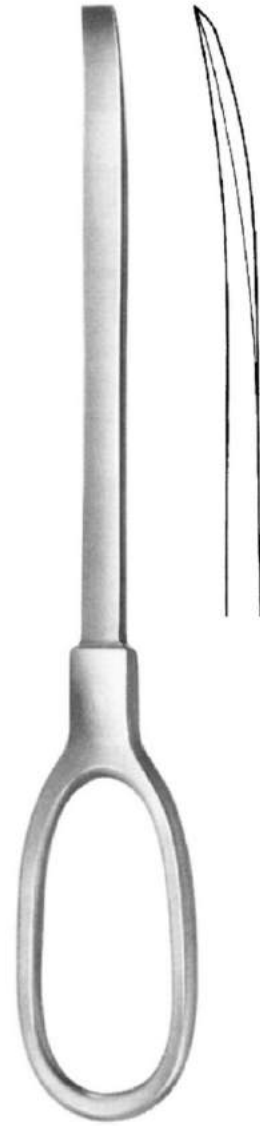

BRISTOW  
38-830-23  
23 cm 9"



## Bone Levers, Meniscus Retractors Elevadores p. huesos, Separadores para menisco



TAYLOR

16.5 cm, 6 1/2"

38-831-16 75 x 30 mm

38-833-16 100 x 30 mm



12 x 13 mm  
38-832-01



52 x 13 mm  
38-832-02

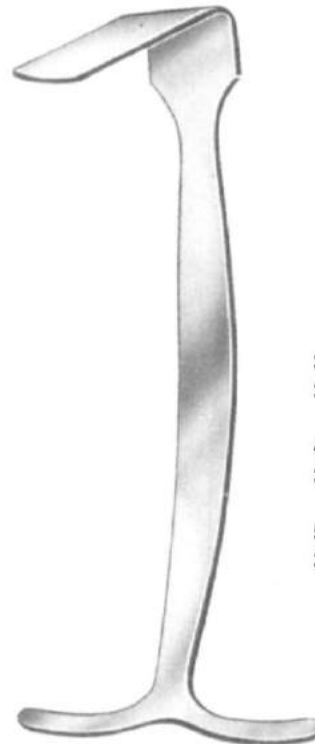

32 x 19 mm  
38-832-03

48 x 19 mm  
38-832-04

57 x 19 mm  
38-832-05

SMILLIE  
14 cm, 5 1/2"



## Tendon, Meniscus, Seizing Instruments Instrumentos para coger tendones



**SMILLIE**  
38-910-17  
17 cm, 6 3/4"

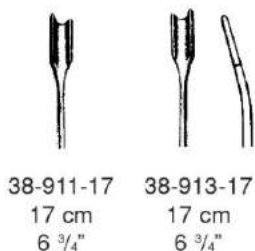

38-911-17 17 cm 6 3/4"  
38-913-17 17 cm 6 3/4"

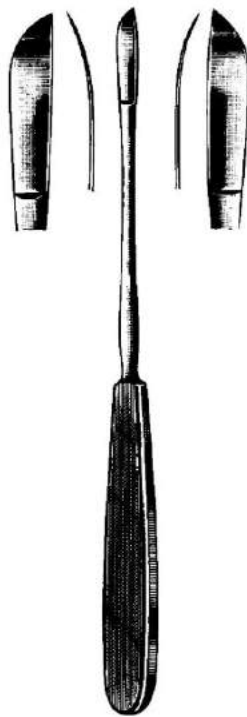

**NEFF**  
38-921-22 38-923-22  
22 cm, 8 3/4"



38-950-01 3 mm  
38-950-02 4 mm  
38-950-03 5 mm  
38-950-04 6 mm  
38-950-05 7 mm

**BUNELL**  
38-950-01 to 38-950-05  
15 cm, 6"



**LARSEN**  
38-960-15 to 38-960-55  
10 cm, 4"

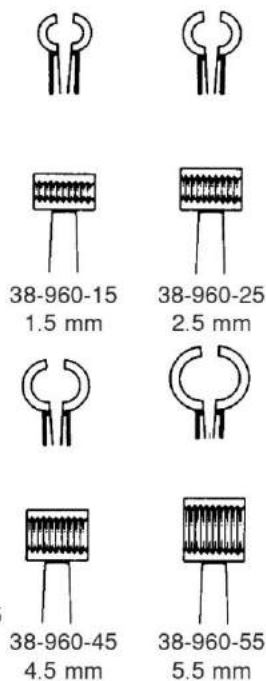

38-960-15 1.5 mm  
38-960-25 2.5 mm  
38-960-45 4.5 mm  
38-960-55 5.5 mm



**JACKSON**  
38-961-15  
15 cm, 6"

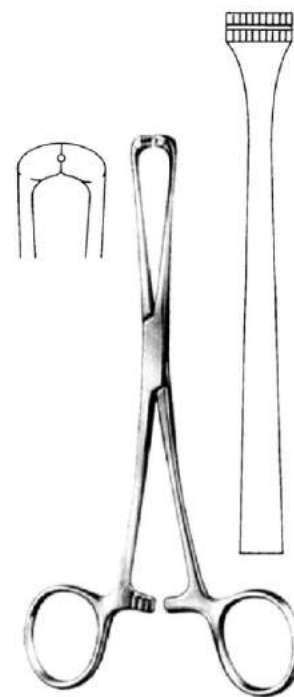

**STEINMAN**  
38-962-16  
16 cm, 6 1/4"



Tendon Seizing and Passing Instruments  
 Instrumentos para coger tendones, Instrumento p. el tunel del tendon



38-963-12  
 12 cm, 4 3/4"



BRAND  
 38-964-15 to 38-964-24 24 cm, 9 1/2"

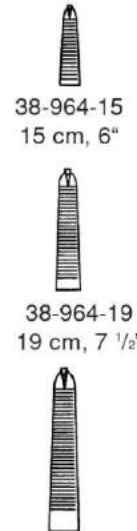

BRAND  
 38-965-15 15 cm, 6"  
 38-965-19 19 cm, 7 1/2"  
 38-965-24 24 cm, 9 1/2"



CAROLL  
 38-966-11  
 11 cm, 4 3/8"

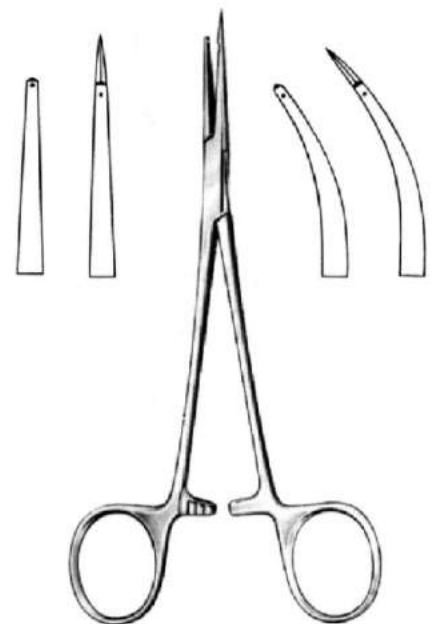

38-966-15 15 cm, 6" 38-967-15



Tendon Seizing Instruments, Tendon Strippers, Bone Files, Rasps  
 Instrumentos para coger tendones, Enucleadores de tendones, Limas, Escofinas



**KLEINERT-KUTZ**  
 38-967-20  
 20 cm, 8"



**BRAND**

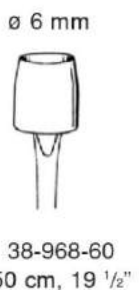
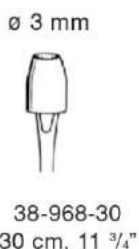

Malleable  
 maleables  
 malleabile

**BUNELL**  
 38-969-18 18 cm, 7"  
 38-969-23 23 cm, 9"



Flexible Shaft  
 Vóstagó maleable  
 camicia flessibile

**BUNELL 23 cm**  
 38-970-01 ø 4.0 mm  
 38-970-02 ø 4.5 mm  
 38-970-03 ø 5.5 mm



38-971-24  
 24.5 cm, 9 3/4"



38-972-22  
 22 cm, 8 3/4"



**PUTTI**  
 38-973-27  
 27 cm, 10 1/2"



**PUTTI**  
 38-975-30  
 30 cm, 11 3/4"

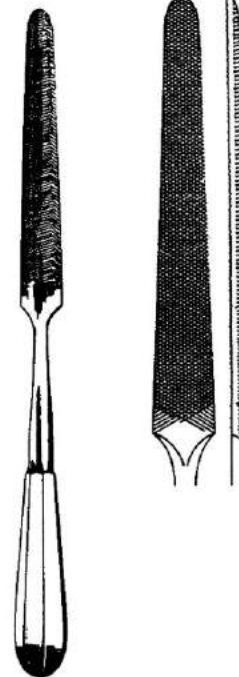

38-977-28  
 28 cm, 11"



## Pneumatic Tourniquet Torniquete neumático



39-101-01  
Complete

Compression Device for Producing Blood Vacuum in Limbs  
Aparato de compresión para producir el vacío de sangre en los miembros  
Vacumentro per determinare vuoti di sangue nelle membra

39-101-02  
Air Pump  
Bomba de aire  
Pompa di aria

39-101-03  
Manometer  
Manómetro  
Manometro

39-101-04  
Bladder for Upper Arm  
Brazalete (brazo)  
Bracciale  
39-101-06 Included

39-101-05  
Bladder for Leg  
Brazalete (pierna)  
Cosciale  
39-101-07 Included

39-101-06  
Bandage Cuff Only for Arm 46 x 6 cm, 18" x 2.4"  
Brazalete para brazo  
Bracciale per braccio superiore

39-101-07  
Bandage Cuff Only for Leg 55 x 10 cm, 21.5" x 10"  
Brazalete para el fémur  
Bracciale per coscia superiore



Amputation and Resection Saws  
Sierras para amputación y resección

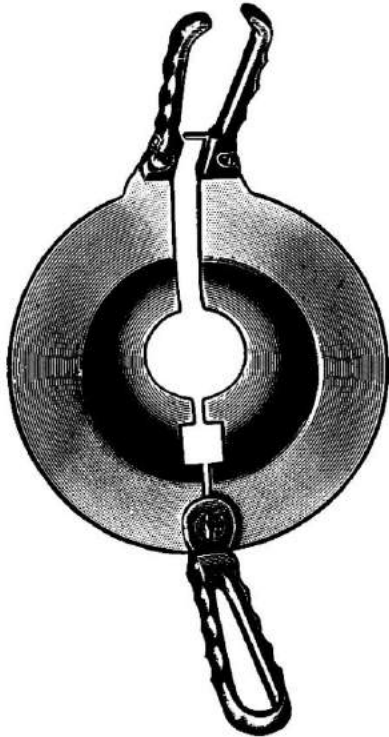

PERCY  
39-110-00

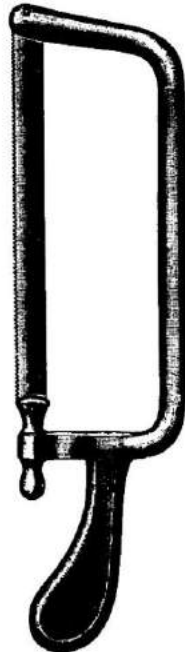

39-112-01  
12 mm Blade

39-112-02  
18 mm Blade

CHARRIERE Complete with one each 12 & 18 mm Blades  
39-112-00



4, 6 & 8 mm

BIER Complete with 3 Blades  
39-114-39  
40.5 cm, 16"



CHARRIERE  
39-116-30  
30 cm, 11 3/4"

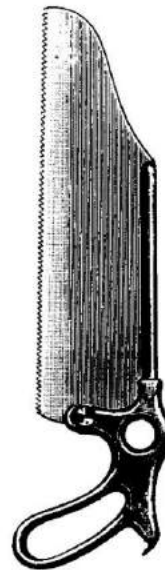

SATTERLEE  
39-118-31  
31 cm, 12 1/4"



LANGENBECK  
39-120-23  
23 cm, 9"





Finger Nail Drill, Finger Nail Forceps, Finger Ring Saws  
Perforadores para uñas, Pinzas para arrancar uñas, Sierras para abrir anillos



39-160-00  
Complete  
completo  
completo



39-160-01

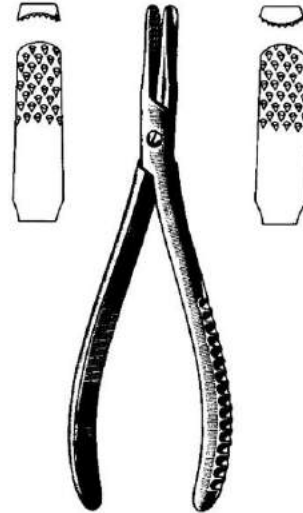

PLATYPUS  
39-161-13 13.5 cm, 5 1/4" 3 mm  
39-162-13 13.5 cm, 5 1/4" 6 mm

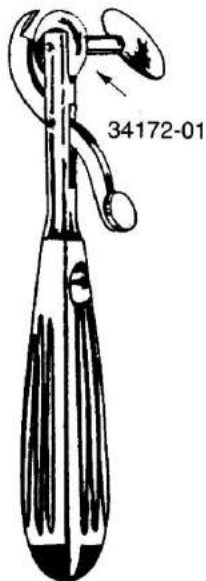

Saw Blade  
Hoja de sierra  
Lama di ricambio

34172-01

WALTON  
39-172-00



Saw Blade  
Hoja de sierra  
Lama di ricambio

39-175-01

BOOTNAS  
39-175-00



## Bone Hand Drills, Bits Perforadores óseos manuales

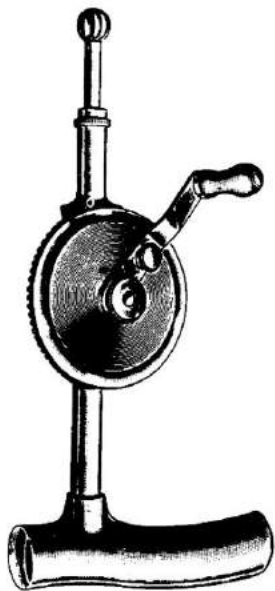

**STILLE**  
39-210-20 20 cm, 8"  
Complete with 39-212-25 to 39-214-16

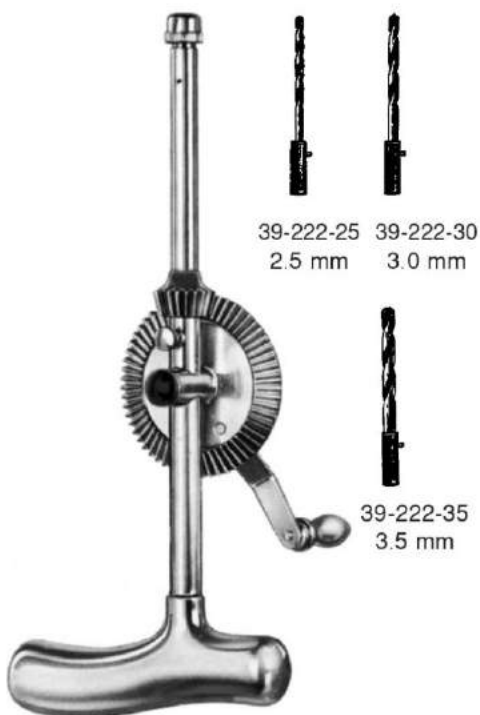
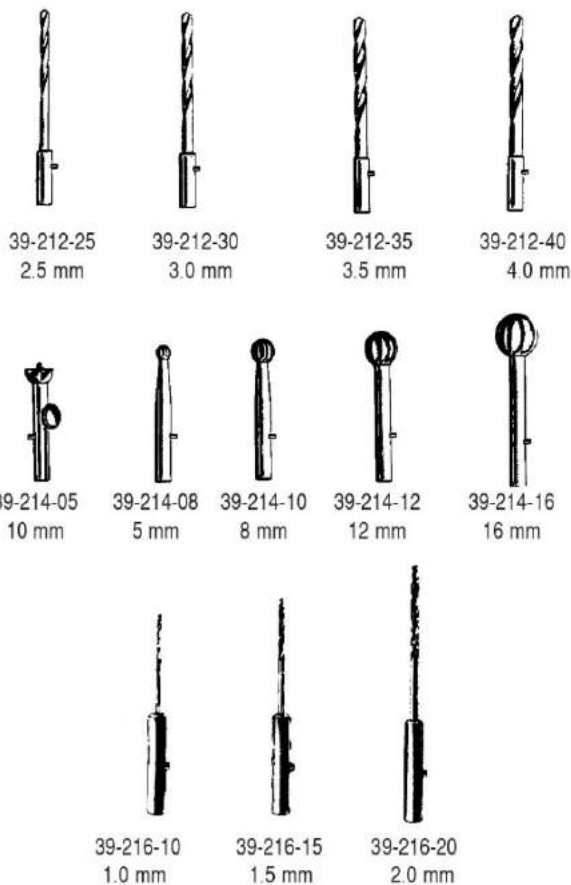

**STILLE-SHERMAN**  
39-220-24 24 cm, 9 1/2"  
Complete with 39-222-25 to 39-222-35



**MOORE**  
39-230-28 28 cm, 11"  
Complete with 39-232-00

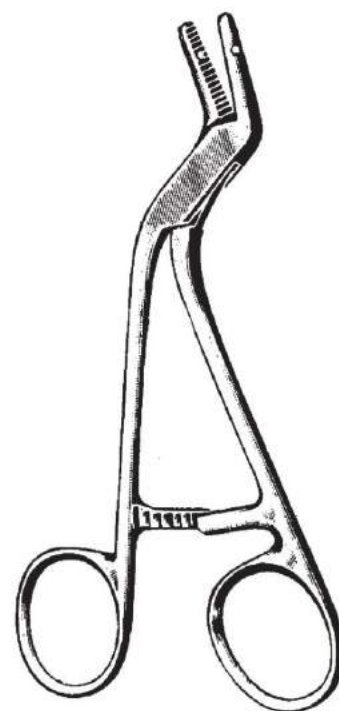

**ADSON**  
39-231-15  
15 cm, 6"



**Bone Hand Drills**  
Perforadores óseos manuales



39-241-00  
Handle Only

**HUDSON Drill**  
39-240-27 27 cm, 10 1/2"  
Complete with  
39-242-09 to 39-242-22



39-242-09  
9 mm



39-242-14  
14 mm



39-242-16  
16 mm



39-242-22  
22 mm



ø 2 mm  
39-243-02



**CUSHING**  
39-244-10  
39-244-14  
39-244-16



**HUDSON Extension Piece**  
39-246-00

**ERRICO**  
39-244-17  
ø 16 mm



**MC KENZIE**  
39-248-00  
ø 13 mm

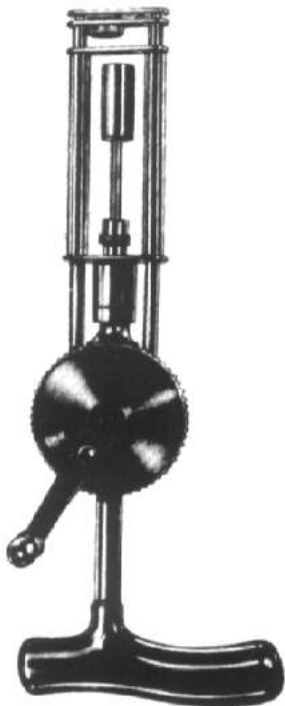

**KIRSCHNER**  
39-250-00 Complete



39-252-00

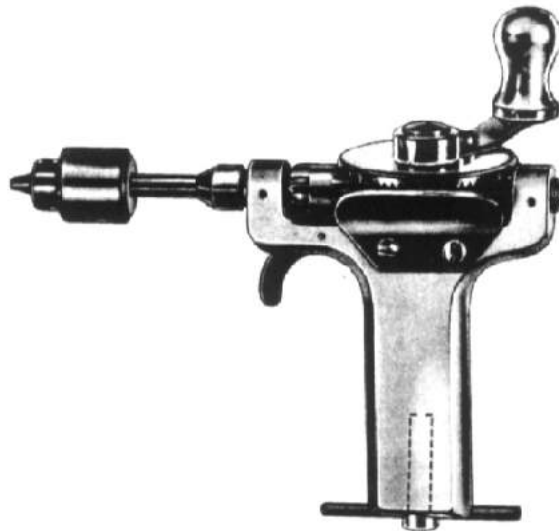

39-270-01  
Chuck Key

**BUNELL**  
39-270-00 16 cm, 6 1/4"

Hand Drill, 16 cm, 6 1/4", Longitudinally Bored  
with Three-Jaw Chuck and Key, Opening up to 4 mm



## Bone Hand Drills, Handles Perforadores óseos manuales



RALK  
39-280-00



39-290-00



Key Only  
39-295-00



Handle with Jacobs Chuck  
and Key  
39-296-00

Hand Drill with Light Metal Case, with Three-Jaw-Chuck and Key, Opening up to D. 6.35 mm  
Perforador manual con caja de aluminio, con mandril de tres mordazas y llave, abriendo hasta 6,35 mm de D.  
Perforatore a mano con cassa in metallo leggero, con mandrino a tre ganasce e chiave, apertura fino a 6,35 mm di D.

Hand Drill with Adjustable Handle, with Jacobs Three-Jaw-Chuck and Key  
Perforador de mano en T con cierre Jacobs de 3 mordazas y llave de ajuste  
Perforatore a mano con manico regolabile, con mandrino a tre ganasce di Jacobs e chiave



39-296-05  
T-Handle, Keyless Locking Chuck  
Mango en T, mordaza sin llave, inox.  
Chiave a T con mandrino a tre ganasce inox



39-296-10  
Handle with Chuck, Including Key  
Mango, mordaza incluyendo llave, inox.  
Mandrino a tre ganasce con manico recto completo di chiave di arresto inox



39-296-15  
HUDSON T-Handle with Fast Gripping Chuck  
Mango en T, acople rápido  
Hudson: mandrino con manico a T  
Ganasce con raccordo rapido



39-296-20  
T-Handle with Fast Gripping Chuck, Large  
Mango en T, acople rápido, grande  
Mandrino a T manico grande  
Raccordo rapido



Handles with Quick Action Chuck, Bone Drill  
Perforador electrico y mangos de acople rápido



39-296-25  
T-Handle, Quick-Action  
Mango en T, acople rápido  
Mandrino a T con raccordo rapido



39-296-30  
Handle, Quick-Action, Large,  
Handle of Hard Fiber  
Mango de acople rápido,  
grande, de material extraduro  
Mandrino grande rapido con  
manico a fibre dure



39-296-35  
Handle, Quick-Action,  
Handle of Hard Fiber  
Mango de acople rápido,  
de material extra-duro  
Mandrino medio rapido con  
manico o fibre dure



39-296-40  
Mini-Handle, Quick-Action,  
"Dental"  
Mini-Mango de acople rápido  
"dental"  
Mini mandrino-rapido con  
impugnatura cilindrica con  
attacco dentale



## Drill Bits Taladros



Ø		
1.0 mm	56 mm	39-320-10
1.5 mm	70 mm	39-320-15
2.0 mm	85 mm	39-320-20
2.5 mm	95 mm	39-320-25
2.7 mm	100 mm	39-320-27
3.0 mm	100 mm	39-320-30
3.2 mm	106 mm	39-320-32
3.5 mm	112 mm	39-320-35
4.0 mm	119 mm	39-320-40
4.5 mm	126 mm	39-320-45
5.0 mm	132 mm	39-320-50
6.0 mm	139 mm	39-320-60
7.0 mm	156 mm	39-320-70

Twist Drills with Round End  
Taladros espirales con vástago redondo  
Perforatore elicoidale



Ø		
1.0 mm	180 mm	39-321-10
1.5 mm	180 mm	39-321-15
2.0 mm	180 mm	39-321-20
2.5 mm	180 mm	39-321-25
2.7 mm	180 mm	39-321-27
3.0 mm	180 mm	39-321-30
3.2 mm	180 mm	39-321-32
3.5 mm	180 mm	39-321-35
4.0 mm	180 mm	39-321-40
4.5 mm	180 mm	39-321-45
5.0 mm	180 mm	39-321-50
6.0 mm	180 mm	39-321-60
6.5 mm	180 mm	39-321-65
7.0 mm	180 mm	39-321-70
8.0 mm	180 mm	39-321-80
9.0 mm	180 mm	39-321-90
10.0 mm	180 mm	39-322-00

Twist Drills, Long  
Taladros espirales, largos  
Perforatore elicoidale, modello lungo



Ø		
1.1 mm	60 mm	39-322-11
1.5 mm	85 mm	39-322-15
2.0 mm	100 mm	39-322-20
2.5 mm	110 mm	39-322-25
2.7 mm	100 mm	39-322-27
3.2 mm	145 mm	39-322-32
3.5 mm	110 mm	39-322-35
4.5 mm	145 mm	39-322-45

Twist Drills, Quick-Action  
Taladros espirales, acople rápido  
Perforatore elicoidale con attacco rapido



Awls  
Escariadores



39-392-14  
14 cm, 5 1/2"

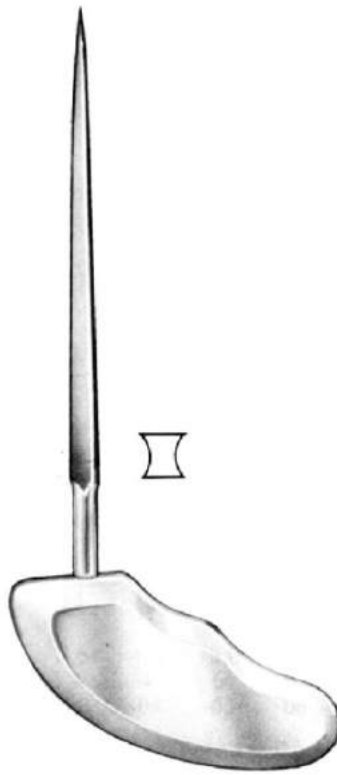

PERTHES  
39-393-21  
21 cm, 8 1/4"

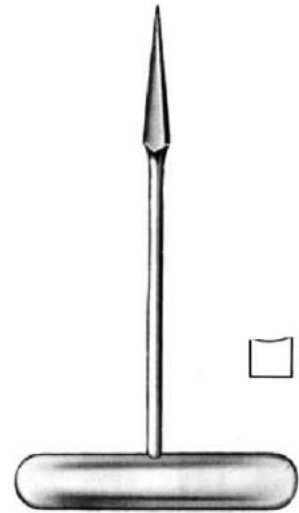

T-BAR  
39-394-14  
14 cm, 5 1/2"





Grasping Forceps, K-Wire Holder  
Pinzas para coger, Soporte de esterilización



39-439-00

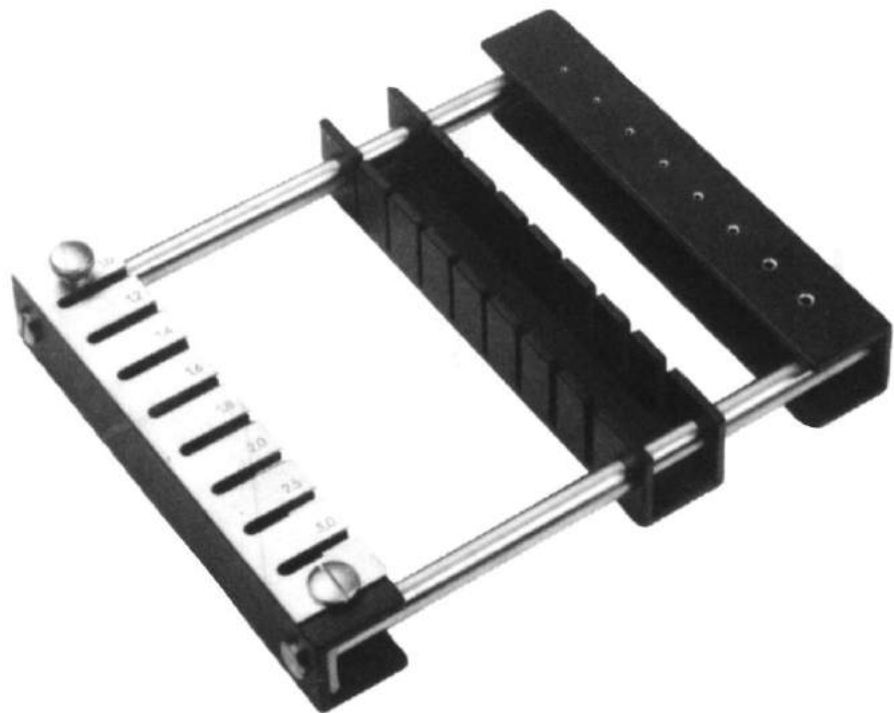

KIRSCHNER Wire Sterilization Holder  
Soporte de esterilización p. alambres de Kirschner  
Supporto per la sterilizzazione dei fili di Kirschner

39-440-01 up to 15 cm, 6"  
39-440-02 up to 31 cm, 12 1/4"  
39-440-03 up to 10 cm, 4"



## Drill Wires Alambres

Packages of 10 Each  
disponible en paquets de 10 unidades

### Trocar Point Punta trocar / Punte trequarti



Ø	10 cm, 4"	15 cm, 6"	31 cm, 12 1/4"
0.8	39-401-08	39-402-08	39-403-08
1.0	39-401-10	39-402-10	39-403-10
1.1	39-401-11	39-402-11	39-403-11
1.2	39-401-12	39-402-12	39-403-12
1.3	39-401-13	39-402-13	39-403-13
1.4	39-401-14	39-402-14	39-403-14
1.5	39-401-15	39-402-15	39-403-15
1.6	39-401-16	39-402-16	39-403-16
1.7	39-401-17	39-402-17	39-403-17
1.8	39-401-18	39-402-18	39-403-18
1.9	39-401-19	39-402-19	39-403-19
2.0	39-401-20	39-402-20	39-403-20
2.2	39-401-22	39-402-22	39-403-22
2.3	39-401-23	39-402-23	39-403-23
2.4	39-401-24	39-402-24	39-403-24
2.5	39-401-25	39-402-25	39-403-25
2.8	39-401-28	39-402-28	39-403-28
3.0	39-401-30	39-402-30	39-403-30

KIRSCHNER  
Round Shaft  
con extremo redondo / con extremo rotondo

### Trocar Point Punta trocar / Punte trequarti



Ø	10 cm, 4"	15 cm, 6"	31 cm, 12 1/4"
0.8	39-404-08	39-405-08	39-406-08
0.9	39-404-09	39-405-09	39-406-09
1.0	39-404-10	39-405-10	39-406-10
1.1	39-404-11	39-405-11	39-406-11
1.2	39-404-12	39-405-12	39-406-12
1.3	39-404-13	39-405-13	39-406-13
1.4	39-404-14	39-405-14	39-406-14
1.5	39-404-15	39-405-15	39-406-15
1.6	39-404-16	39-405-16	39-406-16
1.7	39-404-17	39-405-17	39-406-17
1.8	39-404-18	39-405-18	39-406-18
1.9	39-404-19	39-405-19	39-406-19
2.0	39-404-20	39-405-20	39-406-20
2.2	39-404-22	39-405-22	39-406-22
2.3	39-404-23	39-405-23	39-406-23
2.4	39-404-24	39-405-24	39-406-24
2.5	39-404-25	39-405-25	39-406-25
2.8	39-404-28	39-405-28	39-406-28
3.0	39-404-30	39-405-30	39-406-30

KIRSCHNER  
Flat Shaft  
con extremo plano / con extremo piatto

### Trocar Point D/E Punta trocar / Punte trequarti



Ø	10 cm, 4"	15 cm, 6"	31 cm, 12 1/4"
0.8	39-407-08	39-408-08	39-409-08
0.9	39-407-09	39-408-09	39-409-09
1.0	39-407-10	39-408-10	39-409-10
1.1	39-407-11	39-408-11	39-409-11
1.2	39-407-12	39-408-12	39-409-12
1.3	39-407-13	39-408-13	39-409-13
1.4	39-407-14	39-408-14	39-409-14
1.5	39-407-15	39-408-15	39-409-15
1.6	39-407-16	39-408-16	39-409-16
1.7	39-407-17	39-408-17	39-409-17
1.8	39-407-18	39-408-18	39-409-18
1.9	39-407-19	39-408-19	39-409-19
2.0	39-407-20	39-408-20	39-409-20
2.2	39-407-22	39-408-22	39-409-22
2.3	39-407-23	39-408-23	39-409-23
2.4	39-407-24	39-408-24	39-409-24
2.5	39-407-25	39-408-25	39-409-25
2.8	39-407-28	39-408-28	39-409-28
3.0	39-407-30	39-408-30	39-409-30

KIRSCHNER  
Trocar Shaft  
Punta trocar / Punte trequarti Bilaterali

### Lance Point Punta lanceolar / Punte lanceolata



Ø	31 cm, 12 1/4"
0.8	39-410-08
0.9	39-410-09
1.0	39-410-10
1.1	39-410-11
1.2	39-410-12
1.3	39-410-13
1.4	39-410-14
1.5	39-410-15
1.6	39-410-16
1.7	39-410-17
1.8	39-410-18
1.9	39-410-19
2.0	39-410-20
2.2	39-410-22
2.3	39-410-23
2.4	39-410-24
2.5	39-410-25
2.8	39-410-28
3.0	39-410-30

KIRSCHNER  
Flat Shaft  
con extremo plano / con extremo piatto

Packages of 10 Each  
disponible en paquets de 10 unidades

## Drill Wires, Fracture Pins Alambres, Clavos para huesos

Lance Point  
Punta lanceolar / Punta lanceolata



Ø	31 cm, 12 1/4"
0.8	39-411-08
0.9	39-411-09
1.0	39-411-10
1.1	39-411-11
1.2	39-411-12
1.3	39-411-13
1.4	39-411-14
1.5	39-411-15
1.6	39-411-16
1.7	39-411-17
1.8	39-411-18
1.9	39-411-19
2.0	39-411-20
2.2	39-411-22
2.3	39-411-23
2.4	39-411-24
2.5	39-411-25
2.8	39-411-28
3.0	39-411-30

KIRSCHNER  
Round Shaft  
con extremo redondo / con extremo rotondo

Trocar Point  
Punta trocar / Punta trequarti



	Ø	Ø	Ø	Ø	Ø	Ø	Ø
	3.5 mm	4.0	4.5	4.8	5.0	5.5	6.0 mm
8 cm, 3 1/8"	39-412-08	39-413-08	39-415-08	39-416-08	39-417-08	39-418-08	39-419-08
10 cm, 4"	39-412-10	39-413-10	39-415-10	39-416-10	39-417-10	39-418-10	39-419-10
12 cm, 4 3/4"	39-412-12	39-413-12	39-415-12	39-416-12	39-417-12	39-418-12	39-419-12
14 cm, 5 1/2"	39-412-14	39-413-14	39-415-14	39-416-14	39-417-14	39-418-14	39-419-14
16 cm, 6 1/4"	39-412-16	39-413-16	39-415-16	39-416-16	39-417-16	39-418-16	39-419-16
18 cm, 7"	39-412-18	39-413-18	39-415-18	39-416-18	39-417-18	39-418-18	39-419-18
20 cm, 8"	39-412-20	39-413-20	39-415-20	39-416-20	39-417-20	39-418-20	39-419-20
22 cm, 8 3/4"	39-412-22	39-413-22	39-415-22	39-416-22	39-417-22	39-418-22	39-419-22
23 cm, 9"	39-412-23	39-413-23	39-415-23	39-416-23	39-417-23	39-418-23	39-419-23
24 cm, 9 1/2"	39-412-24	39-413-24	39-415-24	39-416-24	39-417-24	39-418-24	39-419-24
26 cm, 10 1/4"	39-412-26	39-413-26	39-415-26	39-416-26	39-417-26	39-418-26	39-419-26
28 cm, 11"	39-412-28	39-413-28	39-415-28	39-416-28	39-417-28	39-418-28	39-419-28
30 cm, 11 3/4"	39-412-30	39-413-30	39-415-30	39-416-30	39-417-30	39-418-30	39-419-30

STEINMAN  
Round Shaft  
con extremo redondo / con extremo rotondo

Trocar Point  
Punta trocar / Punte trequarti



	Ø	Ø	Ø	Ø	Ø	Ø	Ø	Ø
	3.5 mm	4.0	4.2	4.5	4.8	5.0	5.5	6.0 mm
8 cm, 3 1/8"	39-420-08	39-421-08	39-422-08	39-423-08	39-424-08	39-425-08	39-426-08	39-427-08
10 cm, 4"	39-420-10	39-421-10	39-422-10	39-423-10	39-424-10	39-425-10	39-426-10	39-427-10
12 cm, 4 3/4"	39-420-12	39-421-12	39-422-12	39-423-12	39-424-12	39-425-12	39-426-12	39-427-12
14 cm, 5 1/2"	39-420-14	39-421-14	39-422-14	39-423-14	39-424-14	39-425-14	39-426-14	39-427-14
16 cm, 6 1/4"	39-420-16	39-421-16	39-422-16	39-423-16	39-424-16	39-425-16	39-426-16	39-427-16
18 cm, 7"	39-420-18	39-421-18	39-422-18	39-423-18	39-424-18	39-425-18	39-426-18	39-427-18
20 cm, 8"	39-420-20	39-421-20	39-422-20	39-423-20	39-424-20	39-425-20	39-426-20	39-427-20
22 cm, 8 3/4"	39-420-22	39-421-22	39-422-22	39-423-22	39-424-22	39-425-22	39-426-22	39-427-22
23 cm, 9"	39-420-23	39-421-23	39-422-23	39-423-23	39-424-23	39-425-23	39-426-23	39-427-23
24 cm, 9 1/2"	39-420-24	39-421-24	39-422-24	39-423-24	39-424-24	39-425-24	39-426-24	39-427-24
26 cm, 10 1/4"	39-420-26	39-421-26	39-422-26	39-423-26	39-424-26	39-425-26	39-426-26	39-427-26
28 cm, 11"	39-420-28	39-421-28	39-422-28	39-423-28	39-424-28	39-425-28	39-426-28	39-427-28
30 cm, 11 3/4"	39-420-30	39-421-30	39-422-30	39-423-30	39-424-30	39-425-30	39-426-30	39-427-30

STEINMAN D/E  
Trocar Shaft  
Punta trocar / Punte trequarti Bilaterali



## Fracture Pins Clavos para huesos

Packages of 10 Each  
disponible en paquetes de 10 unidades

Trocar Point  
Punta trocar / Punta trequarti



	Ø	Ø	Ø	Ø	Ø	Ø	Ø	Ø
	3.5 mm	4.0	4.2	4.5	4.8	5.0	5.5	6.0 mm
8 cm, 3 1/8"	39-428-08	39-429-08	39-430-08	39-431-08	39-432-08	39-433-08	39-434-08	39-435-08
10 cm, 4"	39-428-10	39-429-10	39-430-10	39-431-10	39-432-10	39-433-10	39-434-10	39-435-10
12 cm, 4 3/4"	39-428-12	39-429-12	39-430-12	39-431-12	39-432-12	39-433-12	39-434-12	39-435-12
14 cm, 5 1/2"	39-428-14	39-429-14	39-430-14	39-431-14	39-432-14	39-433-14	39-434-14	39-435-14
16 cm, 6 1/4"	39-428-16	39-429-16	39-430-16	39-431-16	39-432-16	39-433-16	39-434-16	39-435-16
18 cm, 7"	39-428-18	39-429-18	39-430-18	39-431-18	39-432-18	39-433-18	39-434-18	39-435-18
20 cm, 8"	39-428-20	39-429-20	39-430-20	39-431-20	39-432-20	39-433-20	39-434-20	39-435-20
22 cm, 8 3/4"	39-428-22	39-429-22	39-430-22	39-431-22	39-432-22	39-433-22	39-434-22	39-435-22
23 cm, 9"	39-428-23	39-429-23	39-430-23	39-431-23	39-432-23	39-433-23	39-434-23	39-435-23
24 cm, 9 1/2"	39-428-24	39-429-24	39-430-24	39-431-24	39-432-24	39-433-24	39-434-24	39-435-24
26 cm, 10 1/4"	39-428-26	39-429-26	39-430-26	39-431-26	39-432-26	39-433-26	39-434-26	39-435-26
28 cm, 11"	39-428-28	39-429-28	39-430-28	39-431-28	39-432-28	39-433-28	39-434-28	39-435-28
30 cm, 11 3/4"	39-428-30	39-429-30	39-430-30	39-431-30	39-432-30	39-433-30	39-434-30	39-435-30

STEINMAN  
Triangular End  
con extremo triangular / con estremo triangolare

Trocar Point  
Punta trocar / Punta trequarti

Threaded Wires  
con rosca  
con filetto



25 mm

Ø	15 cm, 6"	18 cm, 7"	20 cm, 8"	23 cm, 9"	25 cm, 10"	31 cm, 12 1/4"
1.2	39-436-12	39-437-12	39-438-12	39-439-12	39-440-12	39-441-12
1.4	39-436-14	39-437-14	39-438-14	39-439-14	39-440-14	39-441-14
1.6	39-436-16	39-437-16	39-438-16	39-439-16	39-440-16	39-441-16
1.8	39-436-18	39-437-18	39-438-18	39-439-18	39-440-18	39-441-18
2.0	39-436-20	39-437-20	39-438-20	39-439-20	39-440-20	39-441-20
2.4	39-436-24	39-437-24	39-438-24	39-439-24	39-440-24	39-441-24
2.5	39-436-25	39-437-25	39-438-25	39-439-25	39-440-25	39-441-25
2.8	39-436-28	39-437-28	39-438-28	39-439-28	39-440-28	39-441-28
3.0	39-436-30	39-437-30	39-438-30	39-439-30	39-440-30	39-441-30
3.2	39-436-32	39-437-32	39-438-32	39-439-32	39-440-32	39-441-32
3.5	39-436-35	39-437-35	39-438-35	39-439-35	39-440-35	39-441-35

Round Shaft  
con extremo redondo / con estremo rotondo



Packages of 10 Each  
disponible en paquetes de 10 unidades

Fracture Pins  
Clavos para huesos

Trocar Point D/E  
Punta trocar / Punta trequarti

Threaded Wires  
con rosca  
con filetto



Ø	15 cm, 6"	18 cm, 7"	20 cm, 8"	23 cm, 9"	25 cm, 10"	31 cm, 12 1/2"
1.2	39-442-12	39-443-12	39-444-12	39-445-12	39-446-12	39-447-12
1.4	39-442-14	39-443-14	39-444-14	39-445-14	39-446-14	39-447-14
1.6	39-442-16	39-443-16	39-444-16	39-445-16	39-446-16	39-447-16
1.8	39-442-18	39-443-18	39-444-18	39-445-18	39-446-18	39-447-18
2.0	39-442-20	39-443-20	39-444-20	39-445-20	39-446-20	39-447-20
2.4	39-442-24	39-443-24	39-444-24	39-445-24	39-446-24	39-447-24
2.5	39-442-25	39-443-25	39-444-25	39-445-25	39-446-25	39-447-25
2.8	39-442-28	39-443-28	39-444-28	39-445-28	39-446-28	39-447-28
3.0	39-442-30	39-443-30	39-444-30	39-445-30	39-446-30	39-447-30
3.2	39-442-32	39-443-32	39-444-32	39-445-32	39-446-32	39-447-32
3.5	39-442-35	39-443-35	39-444-35	39-445-35	39-446-35	39-447-35

Trocar Shaft  
Punta trocar / Punta trequarti



## K-Wire Dispensers Dispensador para brocas filiformes

12 cm, 4 3/4"



17 cm, 6 3/4"



33 cm, 13"



39-450-08 0.8 mm  
39-450-10 1.0 mm  
39-450-12 1.2 mm  
39-450-14 1.4 mm  
39-450-15 1.5 mm  
39-450-18 1.8 mm  
39-450-20 2.0 mm  
39-450-22 2.2 mm  
39-450-25 2.5 mm  
39-450-30 3.0 mm

39-460-08 0.8 mm  
39-460-10 1.0 mm  
39-460-12 1.2 mm  
39-460-14 1.4 mm  
39-460-15 1.5 mm  
39-460-16 1.6 mm  
39-460-20 2.0 mm  
39-460-22 2.2 mm  
39-460-25 2.5 mm  
39-460-30 3.0 mm

39-470-08 0.8 mm  
39-470-10 1.0 mm  
39-470-12 1.2 mm  
39-470-14 1.4 mm  
39-470-15 1.5 mm  
39-470-16 1.6 mm  
39-470-20 2.0 mm  
39-470-22 2.2 mm  
39-470-25 2.5 mm  
39-470-30 3.0 mm



Finger Protectors, Wire Gauze  
Dedales, Gasa metálica



39-480-01



39-480-02



39-480-03

LANGENBECK  
39-480-01 to 39-480-03



39-492-01  
Small / pequeño / stretto

39-492-02  
Medium / mediano / medio

39-492-03  
Large / grande / grande

39-492-01 to 39-492-03

Sterilizable  
esterilizable  
sterilizzabile



## Extension Bows Estribos para extensión

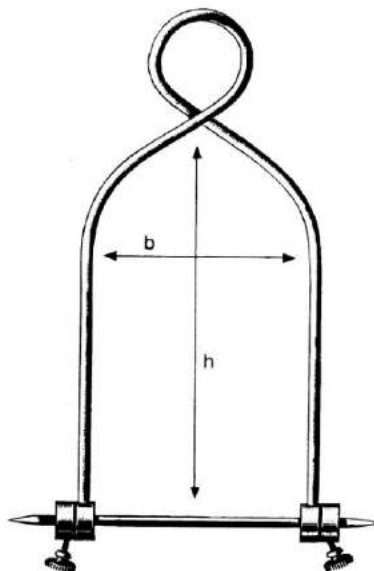

BOEHLER

39-502-16  
For Arm  
para brazo  
per braccio

16 x 9 cm  
6 1/4" x 3 1/2"

39-502-21  
For Thigh and Knee  
para femur y rodilla  
per femore e ginocchio

21 x 11 cm  
8 1/4" x 4 3/8"



KIRSCHNER

39-514-18 40 to 140 mm x 115 mm With 3 Hooks  
con 3 ganchos  
con 3 ganci per trazione

39-514-27 60 to 220 mm x 175 mm With 3 Hooks  
con 3 ganchos  
con 3 ganci per trazione

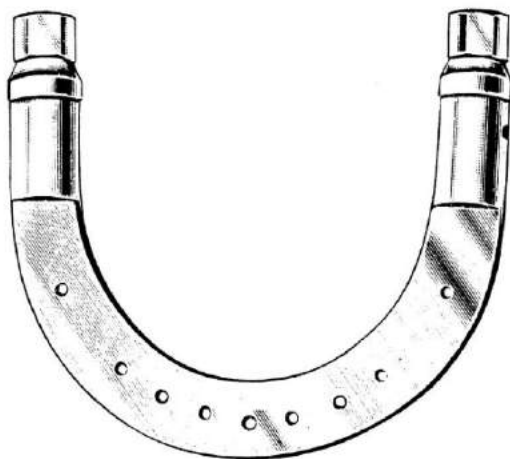

KIRSCHNER

39-515-09	9.5 x 7.0 cm	3 3/4" x 2 3/4"
39-515-10	9.5 x 11.0 cm	3 3/4" x 4 3/8"
39-515-11	10.5 x 10.0 cm	4.25" x 4"
39-515-12	12.0 x 12.0 cm	4 3/4" x 4 3/4"
39-515-13	13.5 x 13.0 cm	5 1/4" x 5 1/8"
39-515-15	15.5 x 15.5 cm	6" x 6"
39-515-20	20.0 x 15.5 cm	8" x 6"

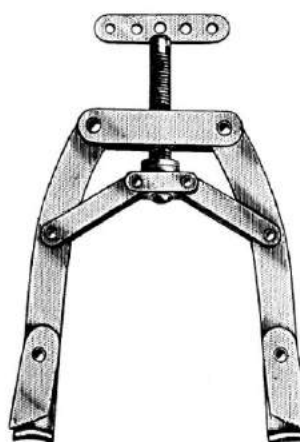

KIRSCHNER U.S.

39-518-01	Medium, Maximum Opening 130 mm, 5 1/8"
39-518-02	Large, Maximum Opening 185 mm, 7 1/4"
39-518-03	Large Extra Long, Maximum Opening 220 mm, 8 3/4"





Wrench, Bone Tool, Hooks  
llave de tuercas, Tensor de taladros, alambres



39-515-01

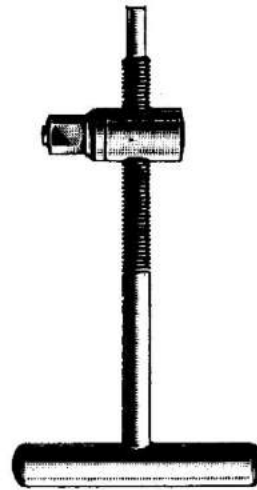

39-515-02

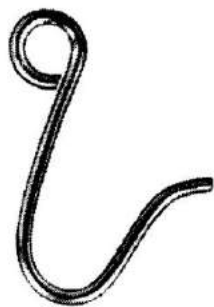

KIRSCHNER  
39-519-01



KIRSCHNER  
39-519-02

Bone Wire  
Hilos para huesos



Soft Wire in Coils 10 Meter Length (32.8 Ft)  
blando, de 10 m (32.8Ft)  
morbido, 10 m (32.8 Ft)

	mm Ø
39-520-02	0.2
39-520-03	0.3
39-520-04	0.4
39-520-05	0.5
39-520-06	0.6
39-520-07	0.7
39-520-08	0.8
39-520-09	0.9
39-520-10	1.0
39-520-12	1.2
39-520-15	1.5



Bone Wire Guides, Bone Wire Tighteners  
Agujas pasa-hilos, Tensor cierra-hilos



DEMEL

27 cm, 10 1/2"

Fig. 1 39-528-01

Fig. 2 39-528-02

Fig. 3 39-528-03

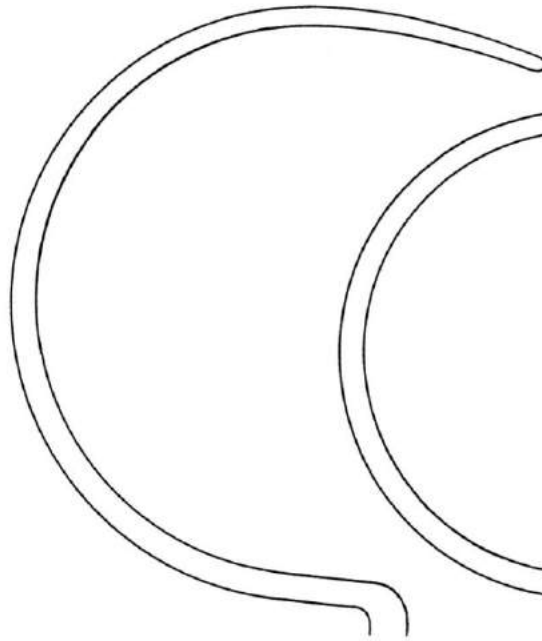

Fig. 1

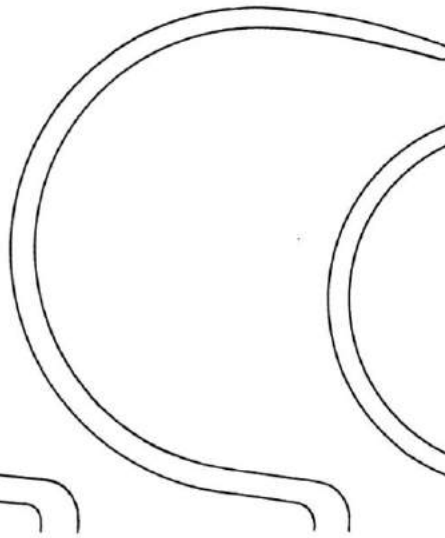

Fig. 2

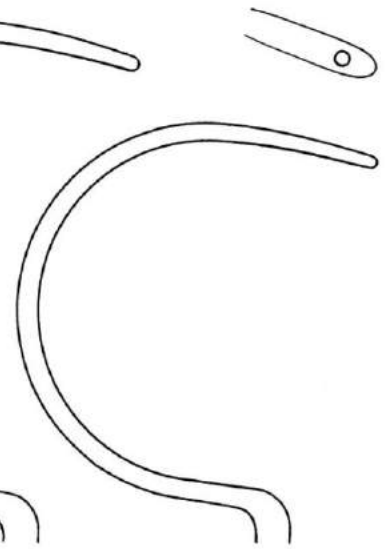
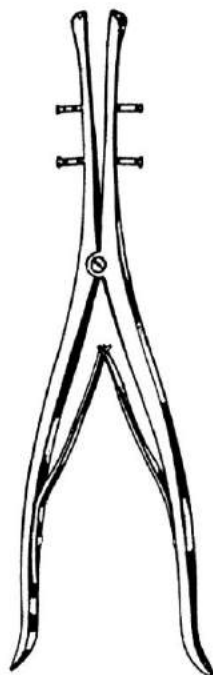
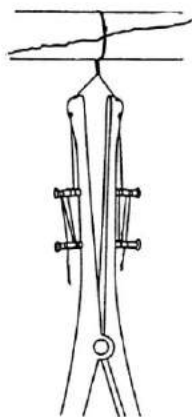

Fig. 3



DEMEL

39-530-28 28 cm, 11"



LOUTE

39-531-21 21 cm, 8 1/4"

## Flat Nose Pliers, Seizing Forceps Alicates planos, Pinzas para coger alambres



Parallel Plier/Wire Cutter  
17 cm, 6 3/4"  
39-533-17

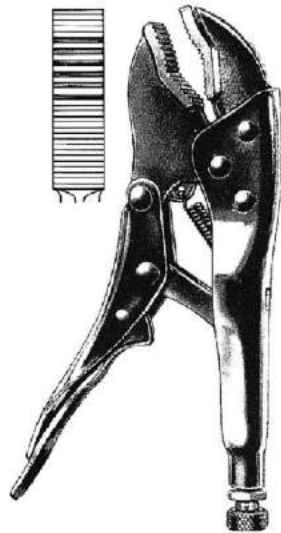

GRIP  
18 cm, 7"  
39-534-18



Dolphin Nose  
39-534-15  
15 cm, 6"

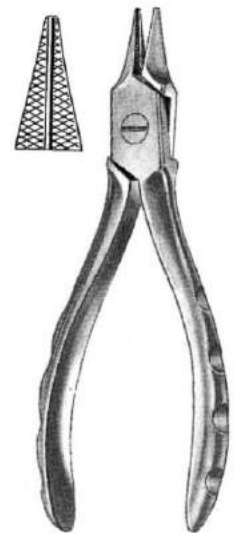

CONE  
39-535-16  
16 cm, 6 1/4"

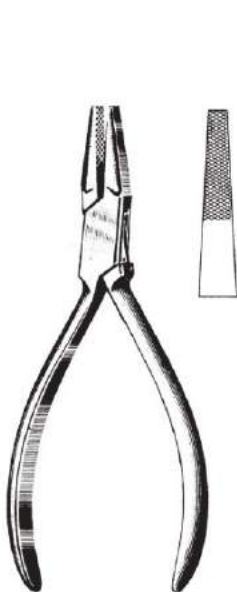

Flat Nose  
39-536-14  
14 cm, 5 1/2"

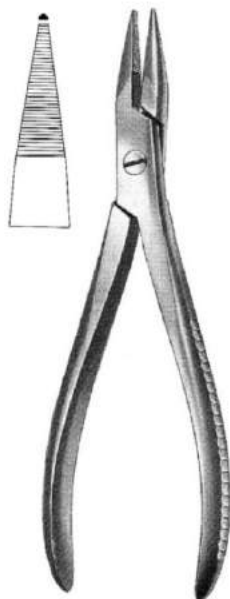

Needle Nose  
39-537-19  
19 cm, 7 1/2"



Double Action Wire Extraction  
18 cm, 7"

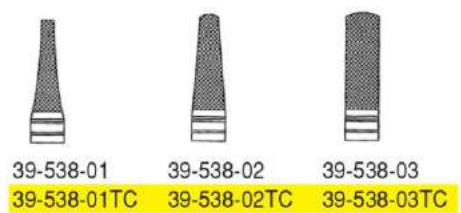



## Flat Nose Pliers, Wire Cutting Pliers Alicates planos, Alicates para cortar alambre



39-540-01



39-540-02

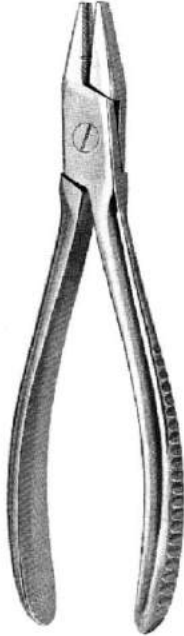

17 cm, 6 3/4"



DIAMOND  
39-540-16  
16 cm, 6 1/4"

Soft Wire 2.0 mm  
Hard Wire 2.0 mm



ANVIL  
39-540-18  
18 cm, 7"



Side Cutter D/A  
39-541-23TC 23 cm, 9"

Soft Wire 3.0 mm  
Hard Wire 2.2 mm



End Cutter D/A Spiral  
39-542-15TC 15 cm, 6"

Soft Wire 2.0 mm  
Hard Wire 1.5 mm



End Cutter D/A  
39-543-23TC 23 cm, 9"

Soft Wire 3.5 mm  
Hard Wire 1.5 mm



Side Cutter  
39-544-18TC 18 cm, 7"

Soft Wire 2.5 mm  
Hard Wire 1.5 mm



## Wire Cutting Pliers, Wire Seizing Forceps Alicates para cortar alambre, Pinzas para coger alambre

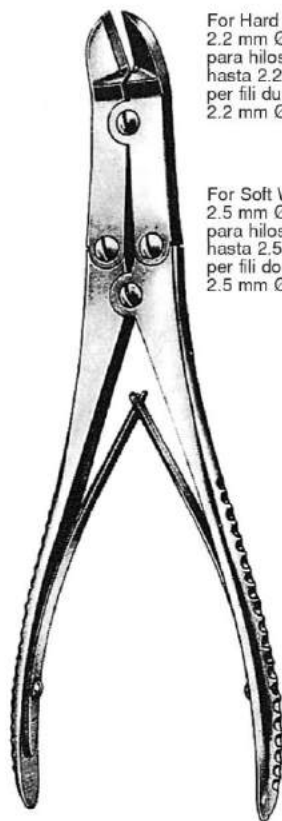

For Hard Wires up to 2.2 mm Ø  
para hilos duros hasta 2.2 mm Ø  
per fili duri a 2.2 mm Ø

For Soft Wires up to 2.5 mm Ø  
para hilos blandos hasta 2.5 mm Ø  
per fili dolci fino a 2.5 mm Ø

Double Action

39-545-22TC 22 cm, 10 1/2"

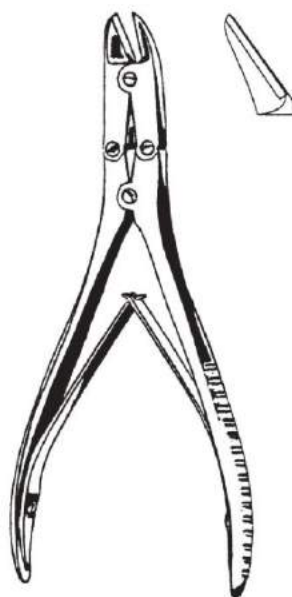

For Hard Wires up to 1.6 mm Ø  
para hilos duros hasta 1.6 mm Ø  
per fili duri a 1.6 mm Ø

For Soft Wires up to 2.0 mm Ø  
para hilos blandos hasta 2.0 mm Ø  
per fili dolci fino a 2.0 mm Ø

Double Action

39-546-16TC 16 cm, 6 1/4"  
39-546-18TC 8 cm, 7"



For Soft Wires up to 2.0 mm Ø  
para hilos blandos hasta 2.0 mm Ø  
per fili dolci fino a 2.0 mm Ø



For Hard Wires up to 1.6 mm Ø  
para hilos duros hasta 1.6 mm Ø  
per fili duri a 1.6 mm Ø

Front and Side

39-548-18TC 18 cm, 7"



Soft Wire 1.5 mm  
Hard Wire 1.0 mm

39-549-14TC 14 cm, 5 1/2"



39-550-13 13 cm, 5 1/8"  
39-550-18 18 cm, 7"

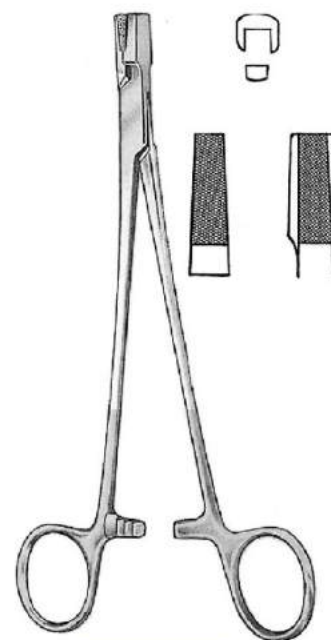

17 cm, 6 3/4"  
39-551-17TC



Wire Twisting Forceps  
Pinzas para torcer hilos



**CORWIN-HEGAR**  
39-552-16TC 16 cm, 6 1/4"



**BERRY**  
39-556-18TC 18 cm, 7"



**MAYO Wire Twister  
TC**



**39-554-15TC**

15 cm  
6"



**39-555-15TC**



**39-554-18TC**

18 cm  
7"



**39-555-18TC**



**39-554-20TC**

20 cm  
8"



**39-555-20TC**



Pin Cutters  
Alicates para cortar clavos



39-558-32 32 cm, 12 1/2"

Up to 2.2 mm  
hasta 2.2 mm



39-559-47TC 47 cm, 18 1/2"

Up to 6 mm  
hasta 6 mm



39-560-57TC 57 cm, 22 1/2"

Up to 6.5 mm  
hasta 6.5 mm





Instruments for Ender and KUENTSCHER Nails  
 Instrumental para Clavos Ender y Küntscher

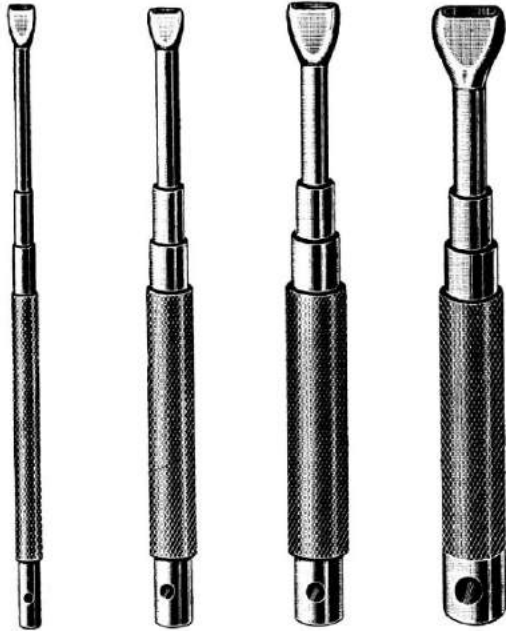

39-562-24	39-562-32	39-562-48	39-562-64
Ø 2.4 mm	3.2 mm	4.8 mm	6.4 mm

Driver-Extractors for Ender Nails  
 Impactores-Extractores para clavos de Ender  
 Impattatore-Estrattore per chiodi di Ender

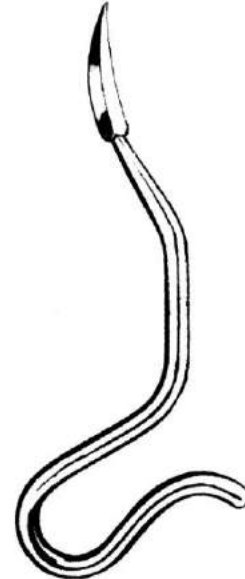

KUENTSCHER	26 cm, 10 1/4"
39-570-01	8 mm
39-570-02	10 mm

Reamers for Medullary Cave  
 Perforadores para la cavidad medular  
 Alesatore per l'apertura del midollo



KUENTSCHER  
 39-573-35 35 cm, 13 3/4"  
 Reamer for Femur  
 Perforador para fémur  
 Alesatore per femore



mm Ø	L/cm
3.5	39-583-60
4.0	39-584-60
5.0	39-585-60

39-581-35 - 39-585-60  
 Guide Pins  
 Guía-conductora para clavos medulares  
 Guida conduttrice



For Nails  
 para clavos  
 per chiodi

Ø 6 to 8 mm  
 39-588-01

Ø 9 to 12 mm  
 39-588-02

Ø 12 to 17 mm  
 39-588-03

KUENTSCHER 19 cm, 7 1/2"

Nail Impactors  
 Impactor final  
 Impattatore finale



## Instruments for KUENTSCHER Nails Instrumental para Clavos Küntscher



39-590-01



39-590-02



KUENTSCHER 63 cm, 24 3/4"  
39-590-00 Complete with 2 Hooks 39-590-01/02  
completo con 2 ganchos  
completo con 2 ganci



Extraction Hooks  
Ganchos extractores  
Gancio d'estrazione

	cm
39-596-29	29, 11.4"
39-596-37	37, 14.5"
39-596-42	42, 16.5"
39-596-49	49, 19.3"

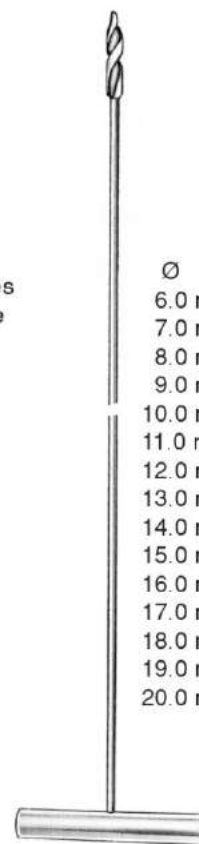

Ø	
6.0 mm	39-597-06
7.0 mm	39-597-07
8.0 mm	39-597-08
9.0 mm	39-597-09
10.0 mm	39-597-10
11.0 mm	39-597-11
12.0 mm	39-597-12
13.0 mm	39-597-13
14.0 mm	39-597-14
15.0 mm	39-597-15
16.0 mm	39-597-16
17.0 mm	39-597-17
18.0 mm	39-597-18
19.0 mm	39-597-19
20.0 mm	39-597-20

Intramedullary Drills  
Perforadores medulares  
Perforatore intramidollare



Nail Inserter  
Introductor clavos / Impattatore  
39-612-00

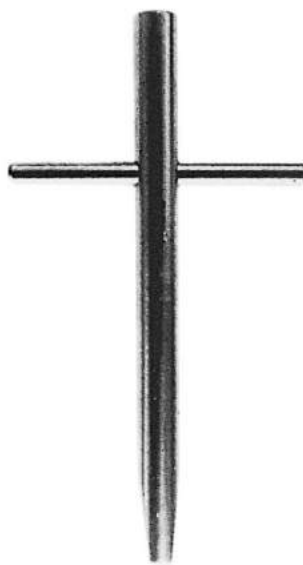

Impactor  
39-613-00



Bender  
39-615-00

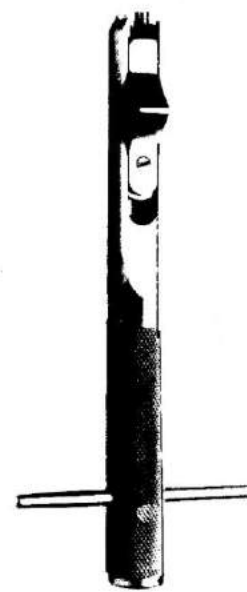

Impactor-Extractor  
Impattatore-Estrattore  
39-617-00



## Screw Drivers Destornilladores



LANE  
39-620-25 25 cm, 10"  
Screw Driver 6 mm  
Destornillador  
Cacciaviti



WILLIAMS  
24 cm  
9 1/2"

3.5 mm



39-624-01



39-624-02



39-624-03



39-624-04



with Ferrozell Handle  
con mango de Ferrozell  
con manico di Ferrozell



39-627-01  
17 cm  
6 3/4"



39-628-02  
25 cm  
10"



39-629-01  
20 cm  
8"

39-628-01  
25 cm  
10"



1.5 mm



2.5 mm



3.5 mm



4.5 mm

39-628-15  
20 cm  
8"

39-628-25  
20 cm  
8"

39-628-35  
20 cm  
8"

39-628-45  
20 cm  
8"



## Screw Drivers Destornilladores



LANE  
39-632-25 25 cm, 10"  
Screw Driver with Cross Slotted Head  
Destornillador para tornillos con ranura en cruz  
Cacciavite a croce



Screw Holder  
Vaina para tornillos  
Guaina per viti esagonali  
39-634-25 2.5 mm  
39-634-35 3.5 mm



Holding Forceps, Bender  
Pinzas para sostener placas y tornillos, Palanca

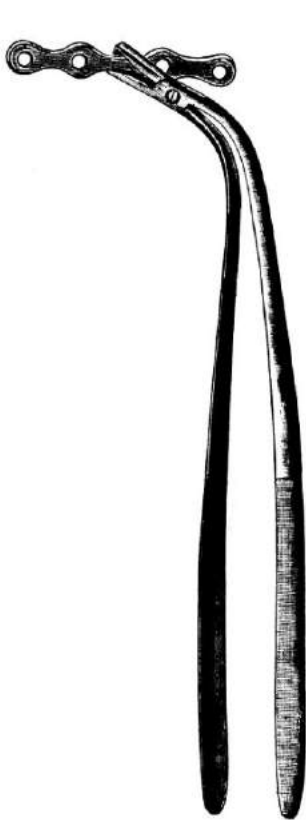

LANE  
39-637-23 23 cm, 9"

Plate Holding Forceps  
Pinza para sostener placas  
Pinza fermo placche

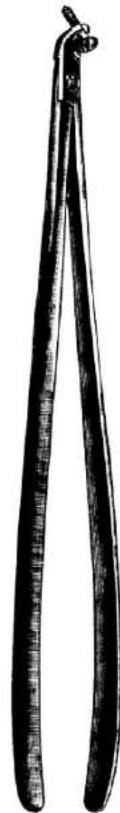

LANE  
39-639-22 22 cm, 8 3/4"

Screw Holding Forceps  
Pinza para sostener tornillos  
Pinza fermo viti

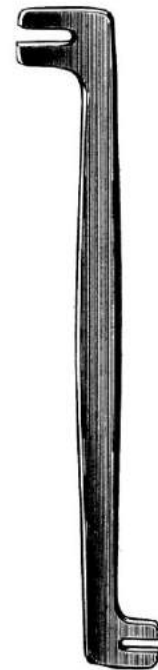

LANE  
39-640-18 18 cm, 7"

Plate Bender  
Palanca para doblar placas  
Leva piega placche

Clip Applying Forceps  
Pinzas aplicadoras, Grapas

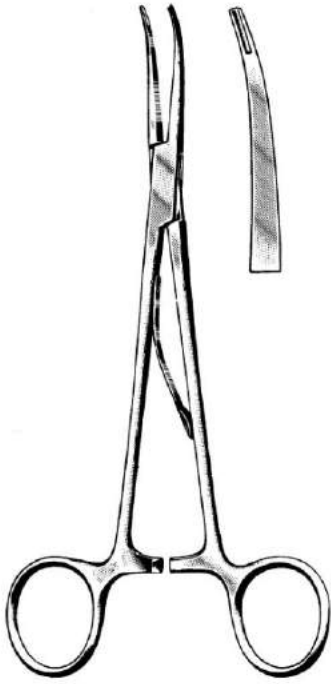

**McKENZIE**  
44-011-15 15 cm, 6"  
44-011-19 19 cm, 7 1/2"



**SMITHWICK**  
44-015-23 23 cm, 9"  
44-015-26 26 cm, 10 1/4"

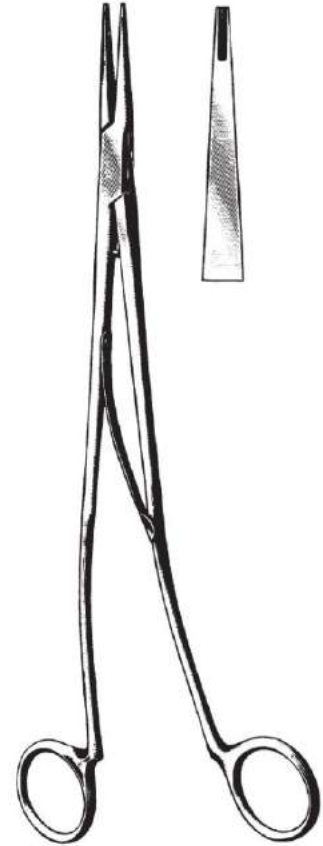

**SWEET**  
44-017-23 23 cm, 9"  
44-017-26 26 cm, 10 1/4"



**OLIVECRONA-TOENNIS**  
44-019-14

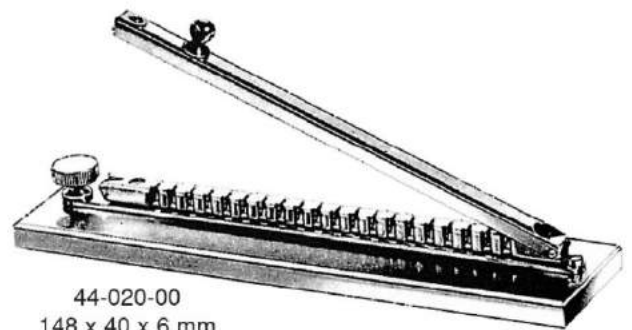

44-020-00  
148 x 40 x 6 mm



44-021-00  
100 Titanium Clips  
100 Grapas de titanio  
100 Agrafes titanio



Cervical Traction Tongs, Clip Applying Forceps  
Pinzas de tracción craneal, Clips, Pinza para aplicar clips

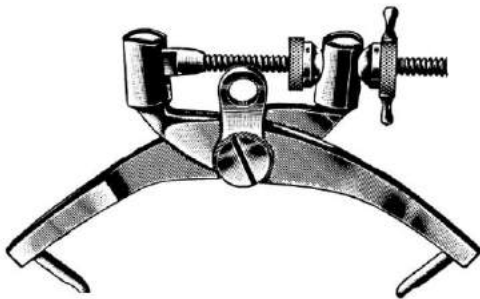

CRUTCHFIELD  
44-025-01



CRUTCHFIELD  
44-025-02



44-026-35  
3.5 mm Ø



44-026-50  
5 mm Ø

Stainless Steel  
Acciaio inox



RANEY  
44-027-00

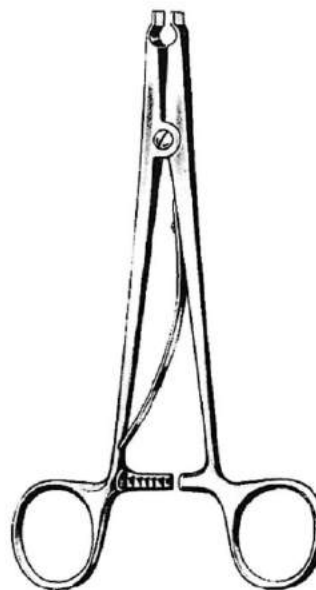

RANEY  
44-028-00



## Nerve Hooks, Dura Hooks Ganchos para nervios y para dura-madre



DANDY  
44-051-20  
20 cm, 8"



DANDY  
44-052-20  
20 cm, 8"



DANDY  
44-053-20  
20 cm, 8"



CRILE  
44-054-20  
20 cm, 8"



CUSHING  
44-056-18  
18 cm, 7"



CUSHING  
44-058-18  
18 cm, 7"

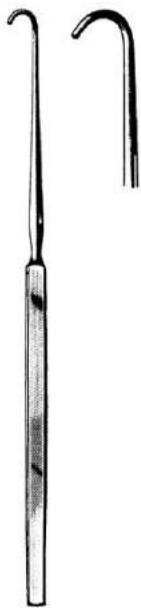

GRAHAM  
44-061-16  
16.5 cm, 6 1/2"



SACHS  
44-064-16  
16.5 cm, 6 1/2"



ADSON  
44-068-20  
20 cm, 8"



ADSON  
44-069-20  
20 cm, 8"



SMITHWICK  
44-070-29  
29 cm, 11.4"





Nerve Root Retractors  
Separadores de raíz de nervios

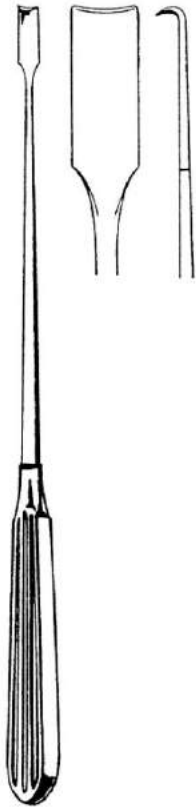

SCOVILLE  
44-074-23  
23 cm, 9"

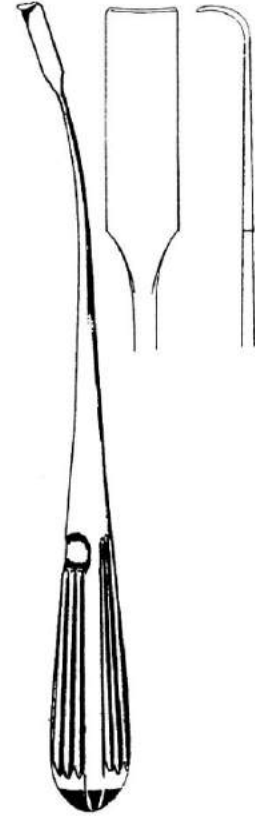

HOLSHER  
44-075-24  
24 cm, 9 1/2"

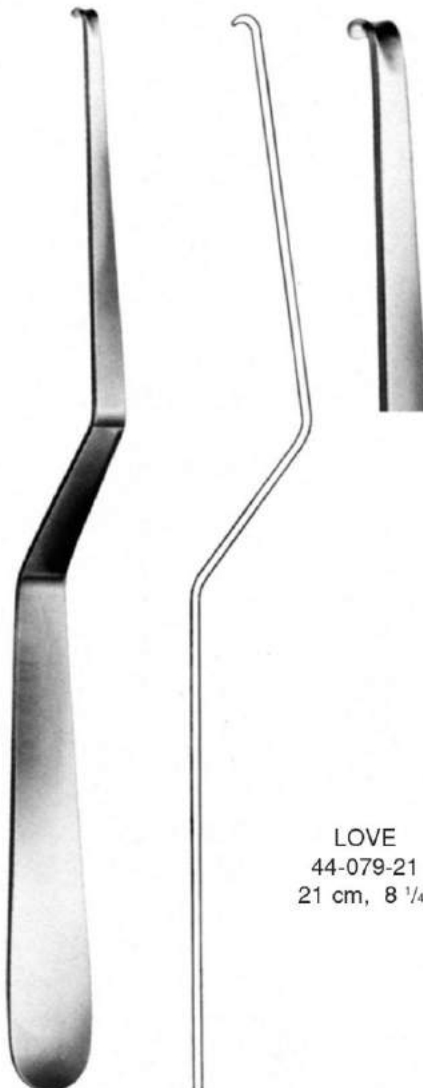

LOVE  
44-079-21  
21 cm, 8 1/4"



Nerve Root Retractors, Galea Hooks  
 Separadores de raíz de nervios, Gancho para galea

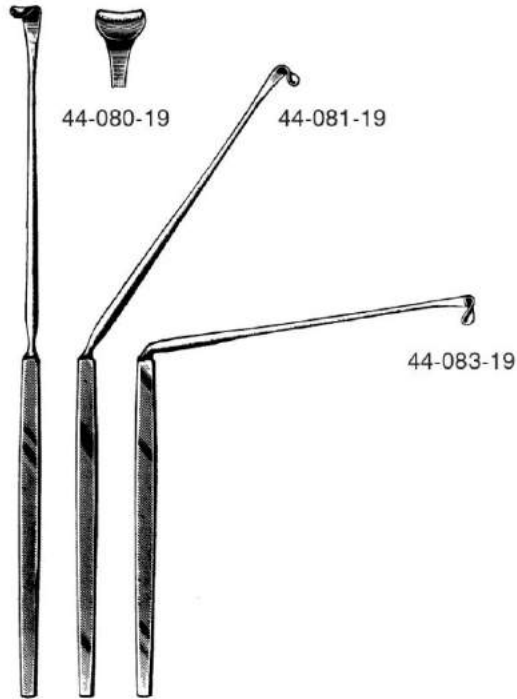

LOVE  
 44-080-19 to 44-083-19

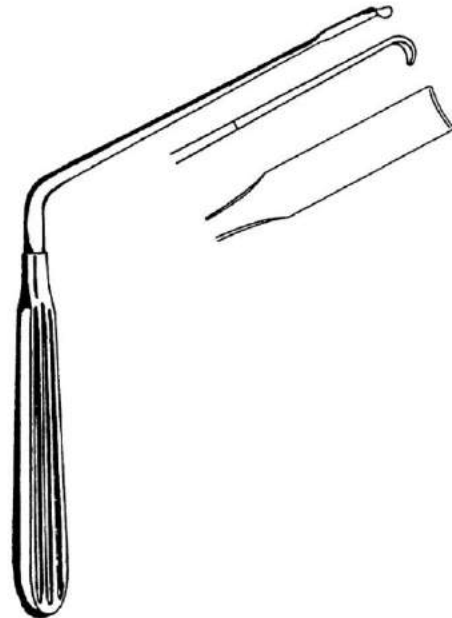

SCOVILLE  
 44-085-20  
 20 cm, 8"



DeMARTEL  
 44-090-33  
 33 cm, 13"



Galea Hooks  
 Gancho p/galea  
 Gancio p/galea

Ø 7 mm

4 mm

YASARGIL  
 44-091-31  
 31 cm, 12 1/4"



Ø 9 mm

6 mm

YASARGIL  
 44-091-41  
 41 cm, 16"



Cranial Punch  
Pinzas sacabocado craneal



CONE  
44-097-22  
22.5 cm 9"



Wire Saw, Dura Dissectors  
Elevadores para la duramadre

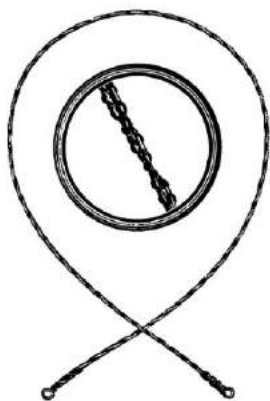

OLIVECRONA	cm
44-092-30	30
44-092-40	40
44-092-50	50
44-092-60	60
44-092-70	70



GIGLI  
44-094-00

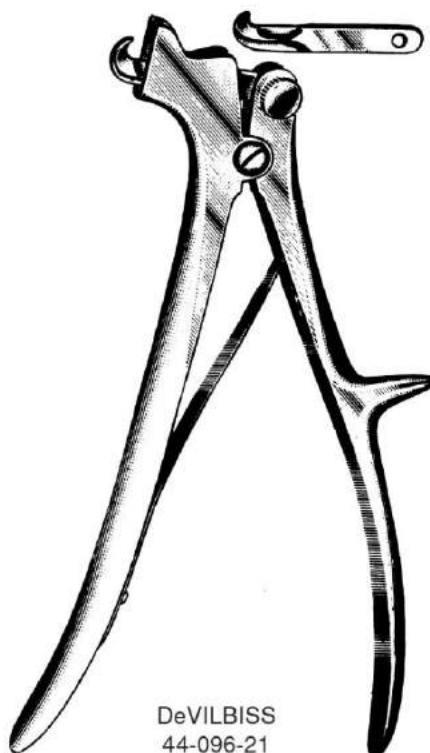

DeVILBISS  
44-096-21  
21 cm, 8 1/4"



TOENNIS  
44-141-25  
25 cm, 10"



SACHS  
44-143-21



SACHS  
44-145-21



OLIVECRONA  
44-146-18 18 cm, 7"  
44-146-24 24 cm, 9 1/2"

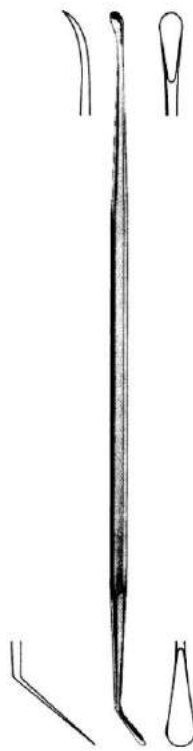

MILLIGAN  
44-147-21



ANMUTH  
44-149-22

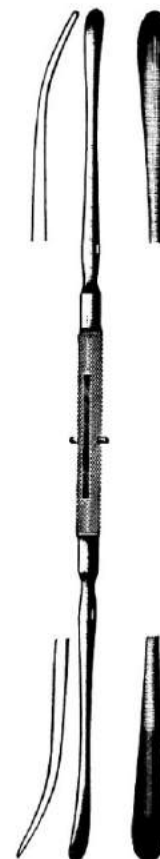

DAVIS  
44-151-24



Dura Dissectors, Knife  
Elevadores, bisturí para duramadre

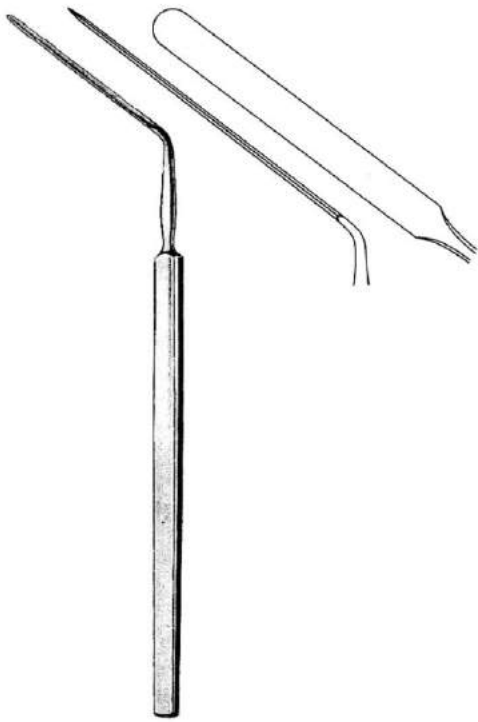

**HORSLEY**  
44-155-20  
20 cm, 8"



**WOODSON**  
44-156-18  
18 cm, 7"



**FRAZIER**  
44-158-01  
15 cm, 6"



**HOEN**  
44-158-02  
15 cm, 6"



**HOEN**  
44-158-03  
15 cm, 6"



**PENFIELD**  
44-161-01  
17.5 cm, 6.9"



**PENFIELD**  
44-161-02  
19.5 cm, 7 3/4"



**PENFIELD**  
44-161-03  
19.5 cm, 7 3/4"



**PENFIELD**  
44-161-04  
21.5 cm, 8 1/2"



**PENFIELD**  
44-161-05  
29 cm, 11.4"



Hypophyseal Forceps, Curette  
Pinzas para hipófisis, Curetas



ADSON  
44-210-23



ADSON  
44-211-23



ADSON  
44-213-23



44-221-00  
19 cm, 7 1/2"



44-222-00  
19 cm, 7 1/2"



44-223-00  
19 cm, 7 1/2"



44-224-00  
19 cm, 7 1/2"



Knives, Hooks, Probes  
Bisturies, Ganchos, Sondas

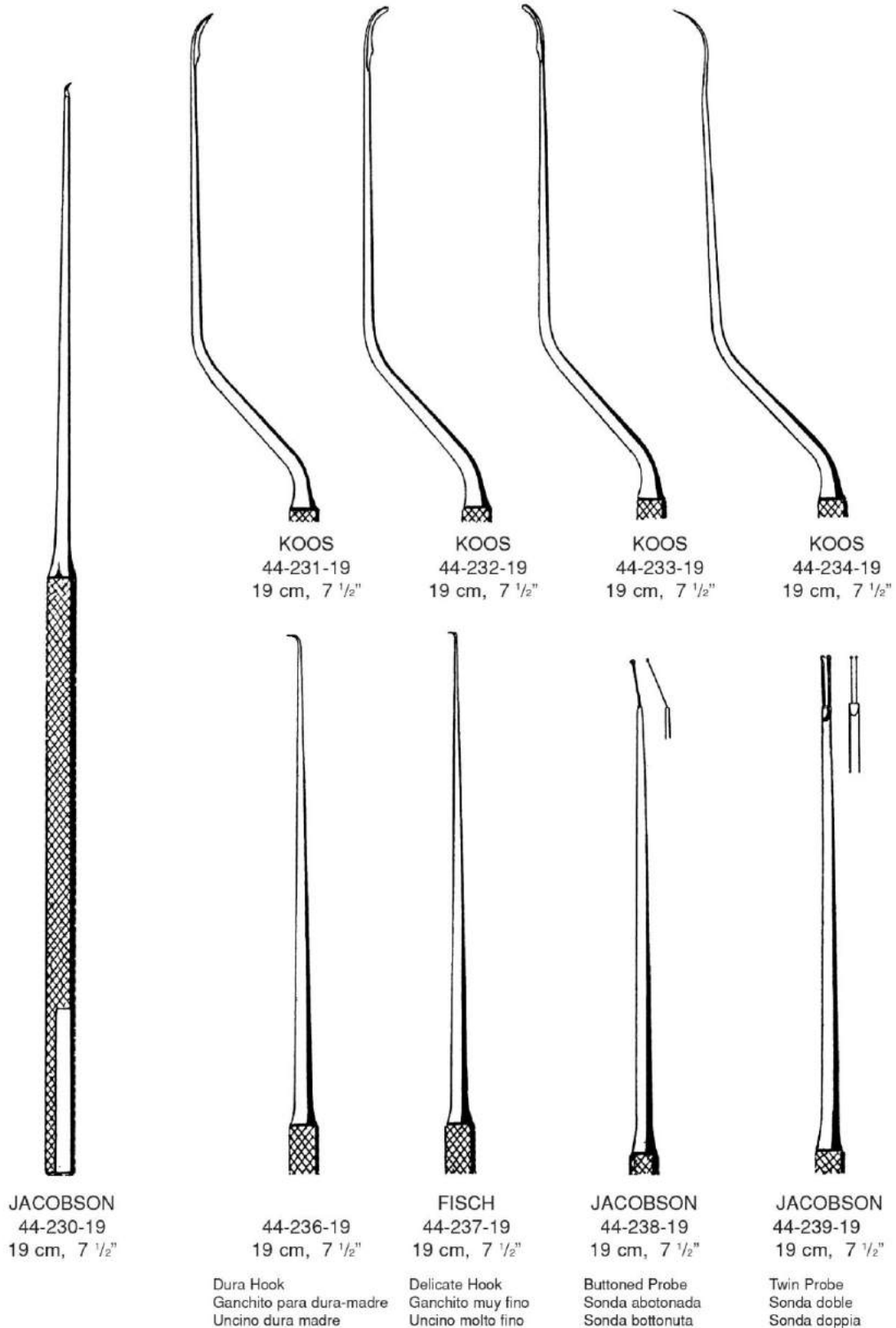



## Nerve Hooks, Brain Spatulas, Suction Tubes Ganchos para nervios, Espatulas cerebrales, Tubos de aspiración



44-242-19



44-243-19



44-244-19  
19 cm, 7 1/2"



44-245-19

### KRAYENBUEHL

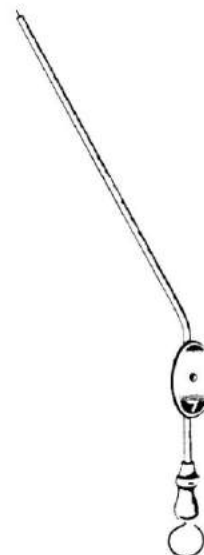

### BARON

- 44-299-03 3 Fr
- 44-299-05 5 Fr
- 44-299-07 7 Fr

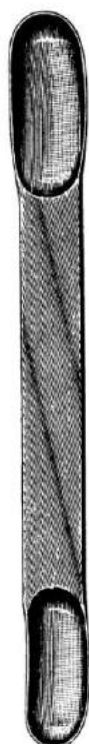

### CUSHING

- 44-250-11 8 x 10 mm
- 44-250-15 13 x 15 mm
- 44-250-18 16 x 18 mm

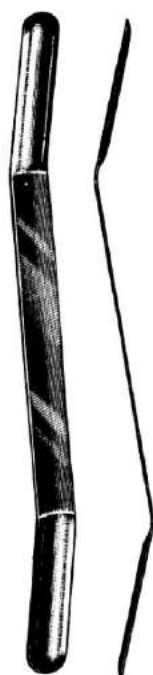

### OLIVECRONA mm

- 44-253-07 7/9
- 44-253-11 11/13
- 44-253-15 15/18
- 44-253-18 18/22



### ADSON

- 44-290-21 21 cm, 8 1/4"
- 4 mm



### FRAZIER

- 44-295-06 to 44-297-12
- 19 cm, 7 1/2"

### Charriere ↕

- | Fr | 30°       | 75°       |
|----|-----------|-----------|
| 6  | 44-295-06 | 44-297-06 |
| 7  | 44-295-07 | 44-297-07 |
| 8  | 44-295-08 | 44-297-08 |
| 9  | 44-295-09 | 44-297-09 |
| 10 | 44-295-10 | 44-297-10 |
| 11 | 44-295-11 | 44-297-11 |
| 12 | 44-295-12 | 44-297-12 |



### FRAZIER

- 44-298-12 12cm / 3 mm





## Suction Tubes Tubos de aspiración

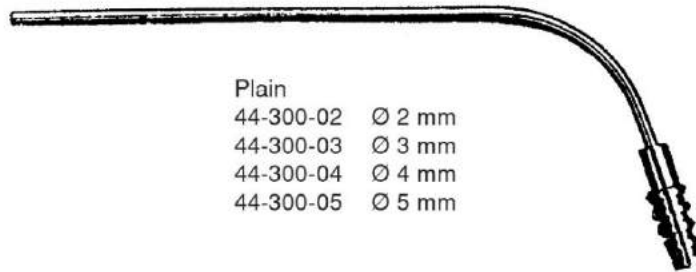

Plain  
 44-300-02 Ø 2 mm  
 44-300-03 Ø 3 mm  
 44-300-04 Ø 4 mm  
 44-300-05 Ø 5 mm



YASARGIL  
 15 cm, 6"  
 Olive 6.5 to 9 mm, Luer  
 44-301-15 Ø 1.5 mm  
 44-301-20 Ø 2.0 mm  
 44-301-25 Ø 2.5 mm  
 44-301-35 Ø 3.5 mm



ZOELLNER  
 44-302-01



ZOELLNER  
 44-302-02



HOUSE  
 9 cm, 3 1/2"  
 44-303-09 Ø 0.9 x 0.7 mm  
 44-303-12 Ø 1.2 x 0.9 mm  
 44-303-15 Ø 1.5 x 1.2 mm  
 44-303-18 Ø 1.8 x 1.8 mm  
 44-303-25 Ø 2.5 x 2.0 mm  
 44-303-30 Ø 3.0 x 2.0 mm  
 44-303-45 Ø 4.5 x 2.0 mm



44-307-14  
 14 cm 5 1/2"



## Suction Tubes, Suction Cannula Tubos de aspiración, Cánulas para aspiración



Tip for Suction Handle  
Cánula para mango  
Cannula per manico  
di aspirazione



### ROSEN

0.5 mm Ø	44-305-05	1.4 mm Ø	44-305-14
0.6 mm Ø	44-305-06	1.5 mm Ø	44-305-15
0.7 mm Ø	44-305-07	1.8 mm Ø	44-305-18
0.8 mm Ø	44-305-08	2.0 mm Ø	44-305-20
0.9 mm Ø	44-305-09	2.5 mm Ø	44-305-25
1.0 mm Ø	44-305-10	3.0 mm Ø	44-305-30
1.2 mm Ø	44-305-12		

0.5 mm Ø	44-306-05
0.7 mm Ø	44-306-07
0.9 mm Ø	44-306-09
1.2 mm Ø	44-306-12

### PLESTER 30°

Charr. 6	44-304-06
Charr. 8	44-304-08
Charr. 10	44-304-10



Suction Handle  
Mango de aspiración  
Manico per aspirazione

WULLSTEIN  
44-306-00



SCHMID  
15 cm, 6"

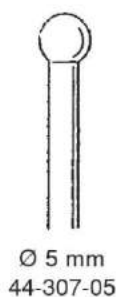



Lamina Spreaders  
Separadores para cuerpos vertebrales



CLOWARD  
44-401-16



INGE  
44-405-17 or 44-405-27

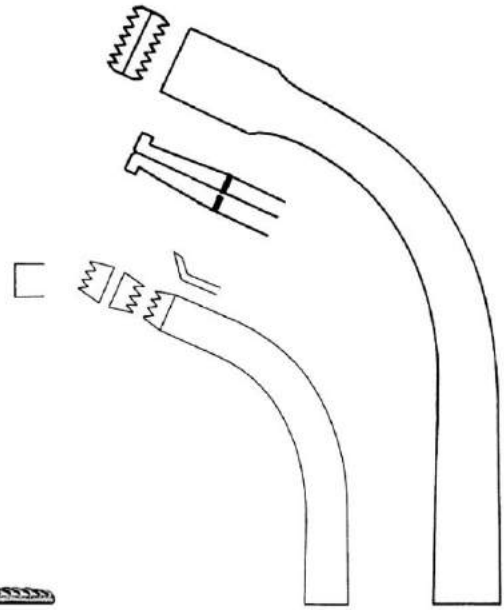

44-405-17  
17 cm  
6 3/4"

44-405-27  
27 cm  
10 1/2"



19 mm

CLOWARD  
44-406-01  
12.5 cm, 5"

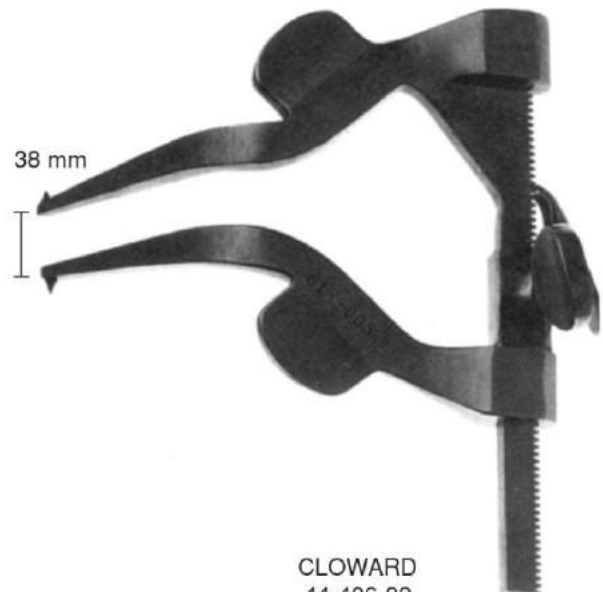

38 mm

CLOWARD  
44-406-02  
7.5 cm, 3"



## Laminectomy Rongeurs Pinzas cortantes para laminectomía

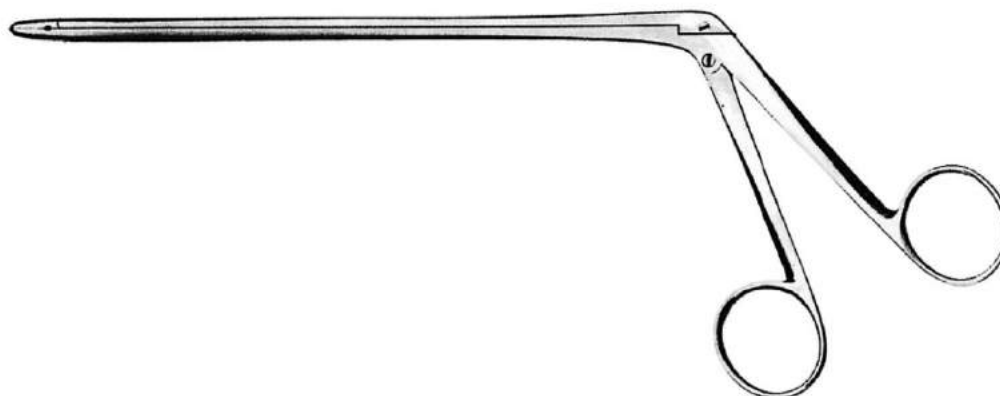

### CUSHING 2 mm



2x10 mm L	2x10 mm/45° L	2x10 mm/45° L	
44-420-01 12.5 cm	44-420-02 12.5 cm	44-420-03 12.5 cm	
44-421-01 15.0 cm	44-421-02 15.0 cm	44-421-03 15.0 cm	
44-422-01 18.0 cm	44-422-02 18.0 cm	44-422-03 18.0 cm	

### LOVE-GRUENWALD 3 mm



3x10 mm L	3x10 mm/45° L	3x10 mm/45° L
44-430-01 12.5 cm	44-430-02 12.5 cm	44-430-03 12.5 cm
44-431-01 15.0 cm	44-431-02 15.0 cm	44-431-03 15.0 cm
44-432-01 18.0 cm	44-432-02 18.0 cm	44-432-03 18.0 cm

### SPURLING 4 mm



4x10 mm L	4x10 mm/45° L	4x10 mm/45° L
44-440-01 12.5 cm	44-440-02 12.5 cm	44-440-03 12.5 cm
44-441-01 15.0 cm	44-441-02 15.0 cm	44-441-03 15.0 cm
44-442-01 18.0 cm	44-442-02 18.0 cm	44-442-03 18.0 cm



Laminectomy Rongeurs  
Pinzas cortantes para laminectomia

185 mm

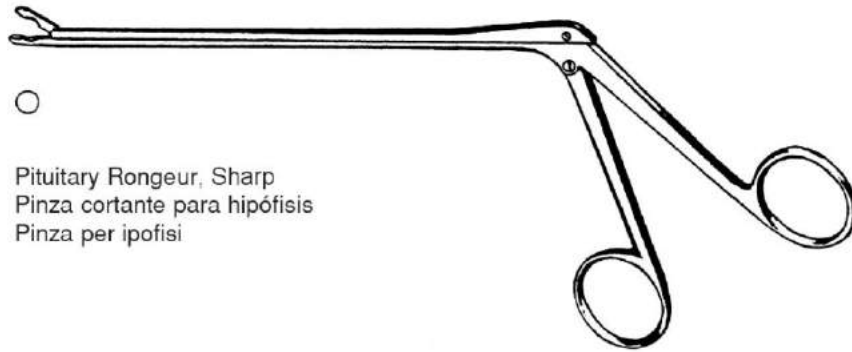

Pituitary Rongeur, Sharp  
Pinza cortante para hipófisis  
Pinza per ipofisi

44-443-26  
25.5 cm, 10"

180 mm

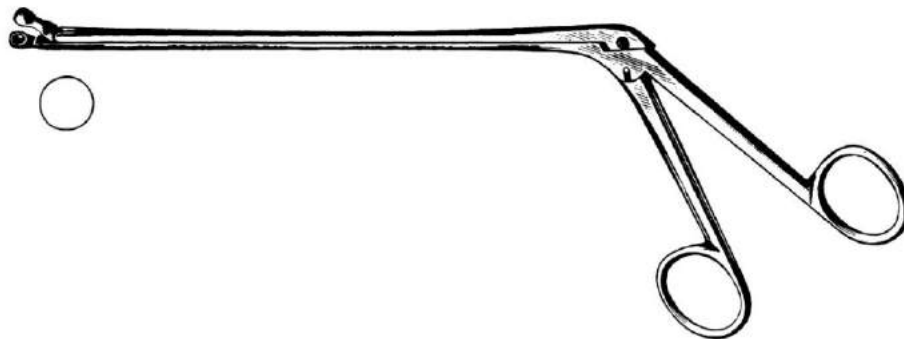

OLDBERG  
44-445-25  
25 cm, 9.8", Ø 7 mm

200 mm

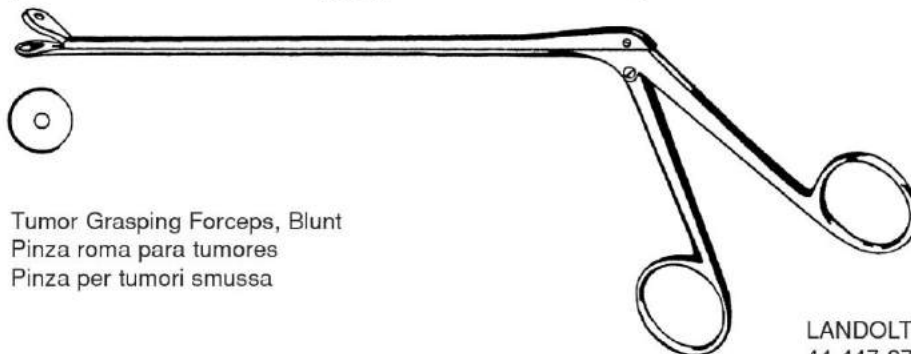

Tumor Grasping Forceps, Blunt  
Pinza roma para tumores  
Pinza per tumori smussa

LANDOLT  
44-447-27  
27 cm, 10 1/2", Ø 9 mm



Laminectomy Rongeurs  
Pinzas cortantes para laminectomía

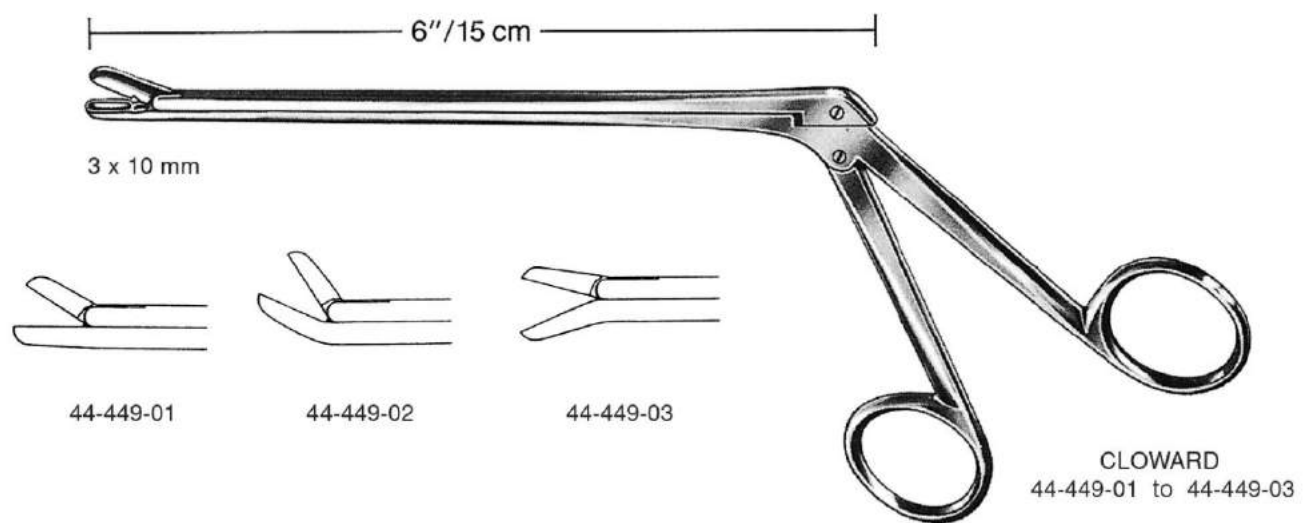
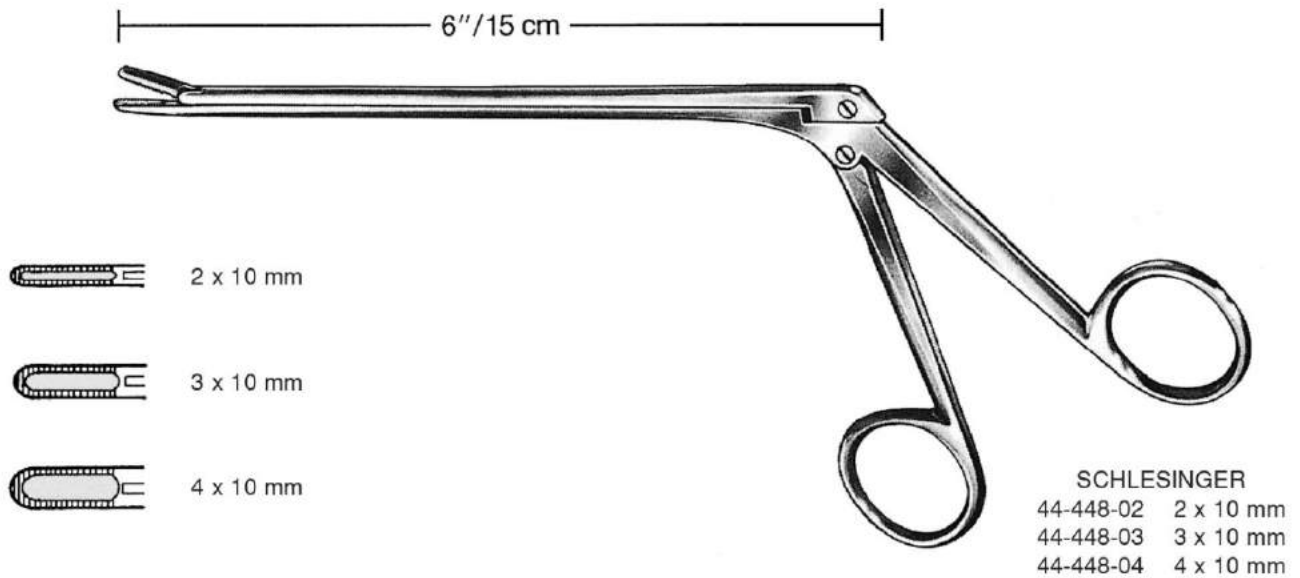



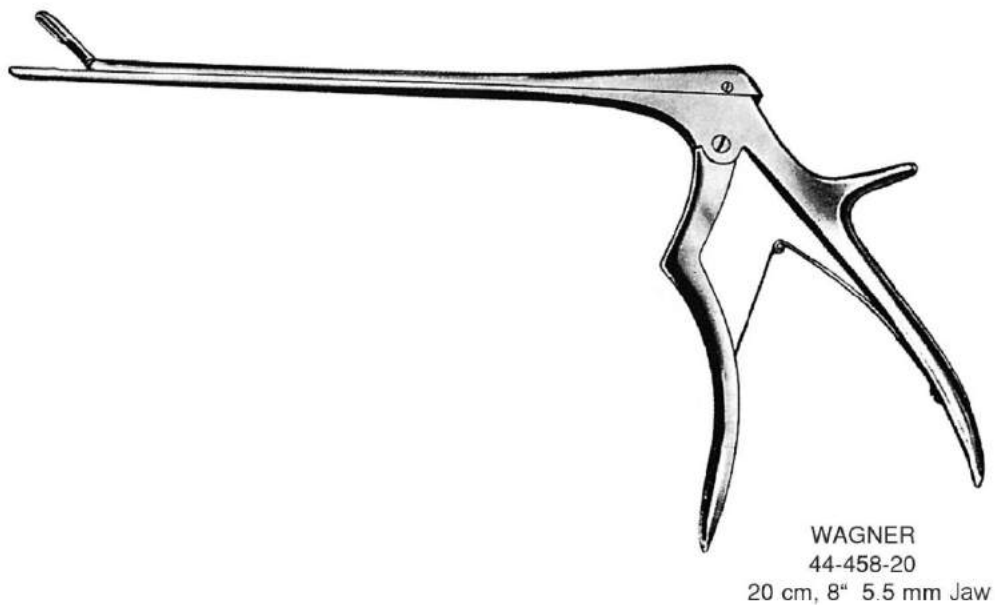
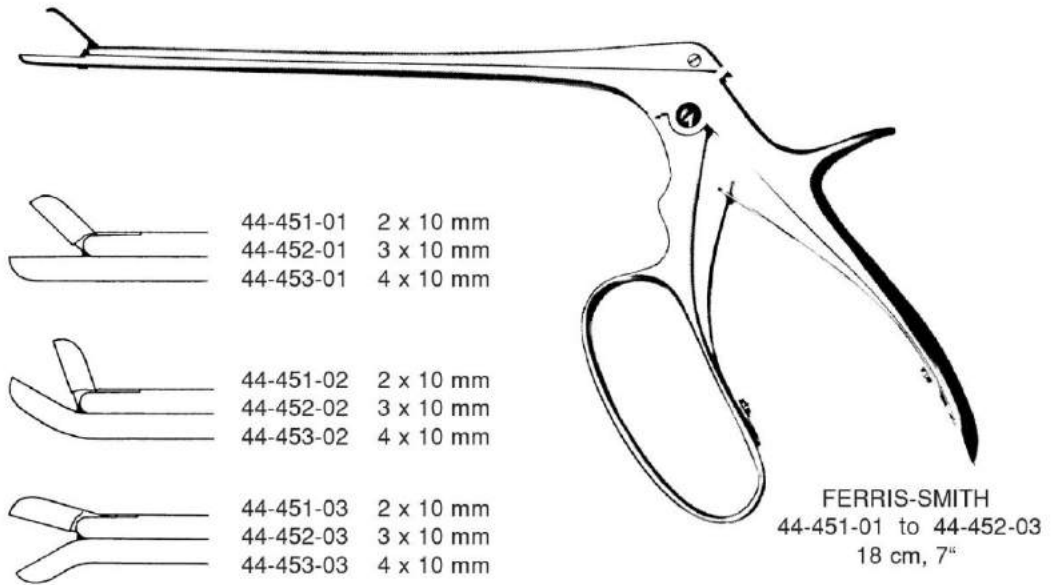

Laminectomy Rongeurs  
Pinzas cortantes para laminectomia



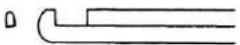
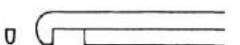
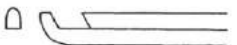
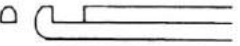
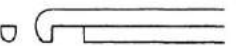
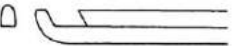
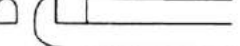
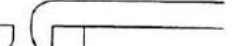
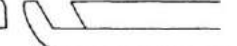
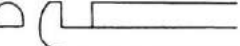
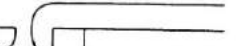
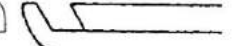
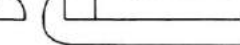

## Intervertebral Disc Rongeurs Pinzas sacabocado para discos intervertebrales

		
44-510-01 1 mm 44-513-01 1 mm	44-511-01 1 mm 44-514-01 1 mm	44-512-01 1 mm 44-515-01 1 mm
		
44-510-02 2 mm 44-513-02 2 mm	44-511-02 2 mm 44-514-02 2 mm	44-512-02 2 mm 44-515-02 2 mm
		
44-510-03 3 mm 44-513-03 3 mm	44-511-03 3 mm 44-514-03 3 mm	44-512-03 3 mm 44-515-03 3 mm
		
44-510-04 4 mm 44-513-04 4 mm	44-511-04 4 mm 44-514-04 4 mm	44-512-04 4 mm 44-515-04 4 mm
		
44-510-05 5 mm 44-513-05 5 mm	44-511-05 5 mm 44-514-05 5 mm	44-512-05 5 mm 44-515-05 5 mm

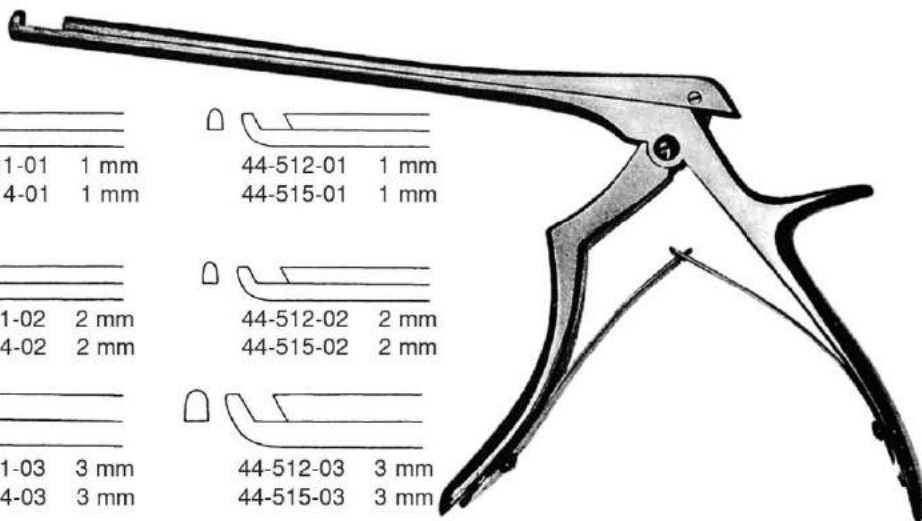

FERRIS-SMITH-KERRISON  
44-510-01 to 44-512-05  
18 cm, 7"

44-513-01 to 44-515-05  
20 cm, 8"

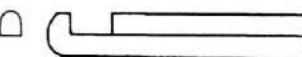
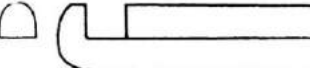
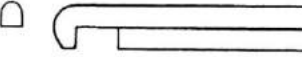
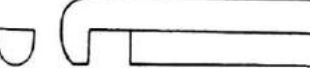
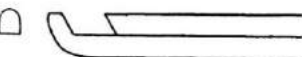
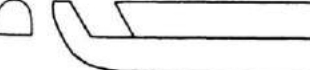
	
3 mm 44-520-03 15 cm, 6" 44-522-03 20 cm, 8"	5 mm 44-520-05 15 cm, 6" 44-522-05 20 cm, 8"
	
3 mm 44-524-03 15 cm, 6" 44-526-03 20 cm, 8"	5 mm 44-524-05 15 cm, 6" 44-526-05 20 cm, 8"
	
3 mm 44-527-03 15 cm, 6" 44-529-03 20 cm, 8"	5 mm 44-527-05 15 cm, 6" 44-529-05 20 cm, 8"

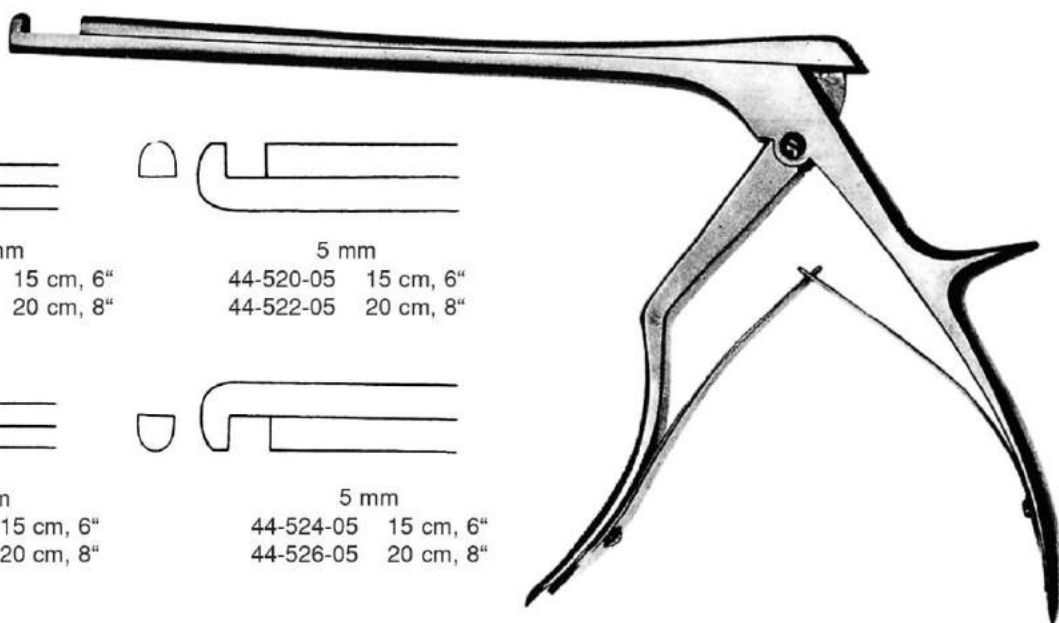

COLCLOUGH  
44-520-03 to 44-529-05





## YASARGIL Aneurysm Vessel Clips YASARGIL – Clips para aneurisma

In High Quality Implant Steel Anti-Magnetic  
de acero inoxidable para implantes de alta calidad, antimagnético  
Prodotto in acciaio di alta qualità, antimagnetico

### Features of the Clip

#### SERIAL NUMBER

Each Clip is coded with an individual serial number which is laser etched.

The serial number guarantees follow up of:

- The entire production process
- The closure force
- Tracking of raw material to the final product

Data is maintained for a period of 10 years.

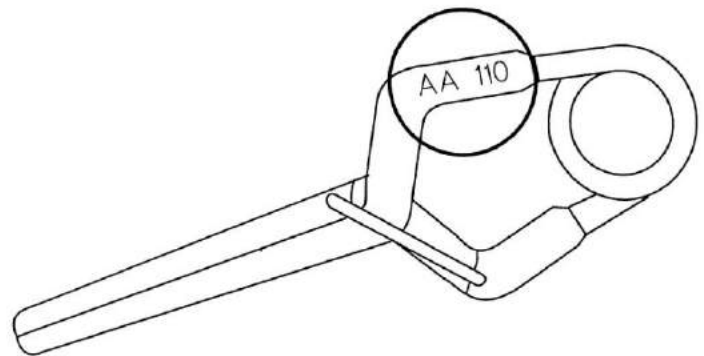

#### PACKING and LABELING

Each Clip is individually packaged in a transparent plastic box.

Special customer packaging requests will be considered. This will be clearly marked on our internal instruction sheet.

The transparent box is marked with a label to ensure quick and accurate identification of the Clip.

The following data is shown on the label:

- Catalog Number
- Product Description
- Illustration
- Closing Force in Grams
- Tolerance Range of Closing Force
- Blade Length
- Maximum Opening
- Blade Geometry
- Serial Number
- Jaw Profile
- Material Description
- Lot Number
- The Notes: "NOT STERILE"
- WARNING

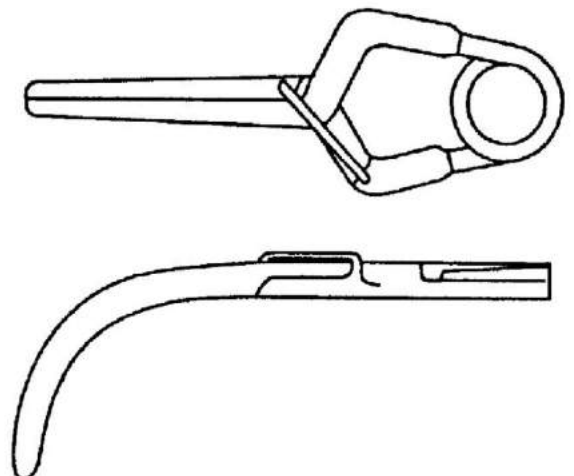



## YASARGIL Aneurysm Vessel Clips YASARGIL – Clips para aneurisma

In High Quality Implant Steel Anti-Magnetic  
de acero inoxidable para implantes de alta calidad, antimagnético  
Prodotto in acciaio di alta qualità, antimagnetico

### Features of the Clip

#### JAW PROFILE

The rounded, pyramid like structure is stamped into the jaw through a special production step that eliminates sharp inner edges.

Additional rounding of structures that border the clip's outer sides, creates a smooth surface that results in a thorough atraumatic application.

Increased surface area is created by the pyramid-like design of the jaws inner surface with it's cross-like structure that doubles the tissue-holding area.

Applied pressure is distributed evenly over the length of the jaw.

The convex design of the Clip provides for a secure and atraumatic closure of the aneurysm.

Sliding of the clip is prevented.

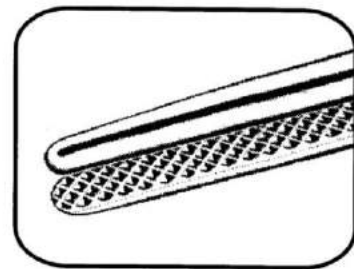
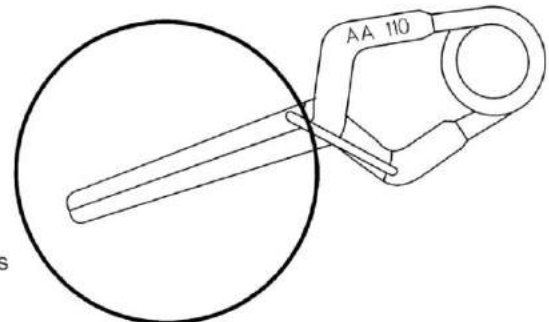

#### SPRING DESIGN

The spring size, which is different in the Standard and Mini Clips, is uniform by Clip type.

Aneurysm Clips are securely placed with the use of our specially designed Appliers.

#### LINK DESIGN

Laser welded.

The link ensures the precise guidance of the jaws and a "soft" opening of the clip during the whole spreading process.

The contact surface of the jaws are guided symmetrically in an exact way "over the entire jaw length". This guarantees the additional stability of the clip.

Over-stress of the material is not possible due to the design of the link which limits the maximum opening width.

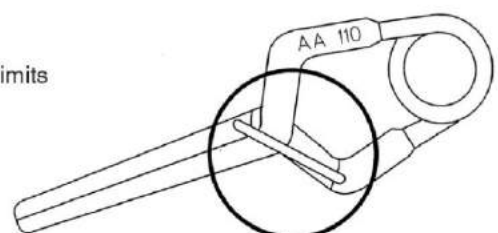
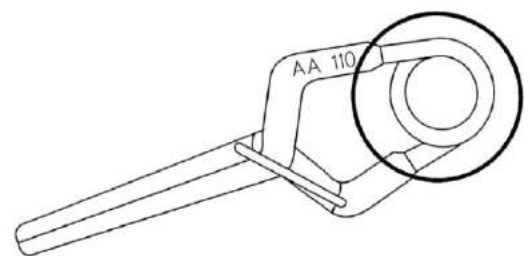



## YASARGIL Aneurysm Vessel Clips YASARGIL – Clips para aneurisma

In High Quality Implant Steel Anti-Magnetic  
de acero inoxidable para implantes de alta calidad, antimagnético  
Prodotto in acciaio di alta qualità, antimagnetico

### Features of the Clip

#### CLOSING FORCE

The closing force is measured at one third of the jaw length and an opening of 0,5 mm.

Final quality control of each clip is performed with microprocessor controlled measuring equipment.

The closing force is indicated within a certain tolerance range.

A special software program ensures that before the clip passes final quality control, its closure force is fixed. This automated process excludes any kind of additional manipulation.

All relevant technical data is stored during the control procedure and printed on the label.

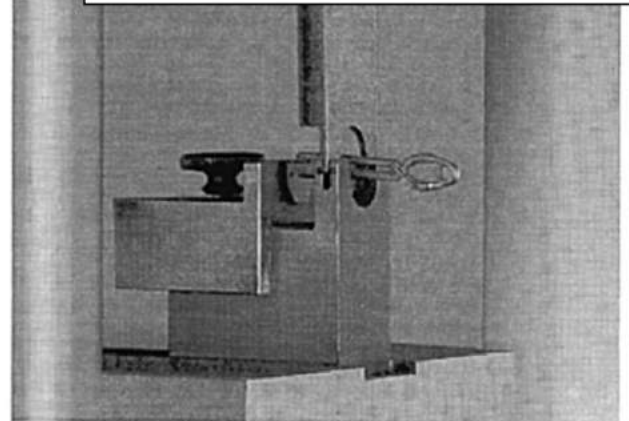
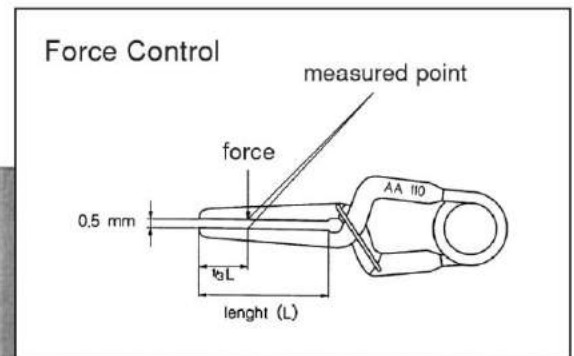

### Material and Quality Assurance

According to DIN 17445, Implant Steel is used in the production of our Aneurysm Clip.

- High stability characteristics
- Excellent tissue compatibility
- Secure closure of blood vessels
- Anti-Magnetic
- Ideally suited as implantation material
- Security against over stressing

## YASARGIL Aneurysm Vessel Clips YASARGIL – Clips para aneurisma

In High Quality Implant Steel Anti-Magnetic  
de acero inoxidable para implantes de alta calidad, antimagnético  
Prodotto in acciaio di alta qualità, antimagnetico

Instructions for the Catalog System  
Explicaciones para el sistema del catálogo  
Esempio del sistema del catalogo

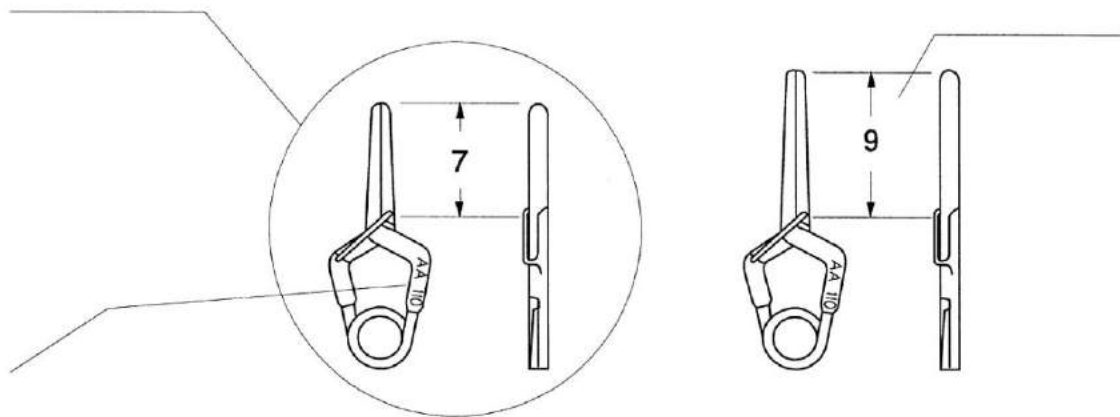



## YASARGIL Aneurysm Vessel Clips YASARGIL – Clips para aneurisma

In High Quality Implant Steel Anti-Magnetic  
de acero inoxidable para implantes de alta calidad, antimagnético  
Prodotto in acciaio di alta qualità, antimagnetico

YASARGIL-STANDARD for Permanent Closure  
YASARGIL-STANDARD para cierre permanente  
YASARGIL-STANDARD con chiusura permanente

### Standard

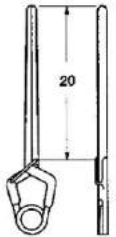
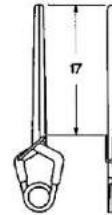
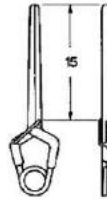
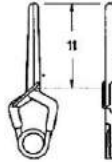
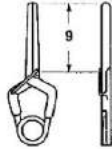
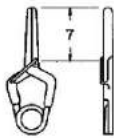

Catalog Number	44-600-62 44-600-62 T	44-600-70 44-600-70 T	44-600-78 44-600-78 T	44-600-92 44-600-92 T	44-601-10 44-601-10 T	44-601-11 44-601-11 T
Max. Opening	6,2 mm 150 gms	7,0 mm 180 gms	7,8 mm 180 gms	9,2 mm 200 gms	10,6 mm 200 gms	11,4 mm 200 gms

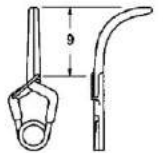
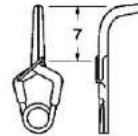
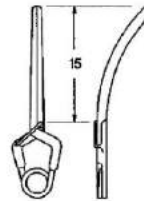
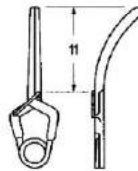
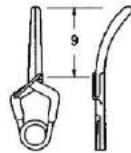
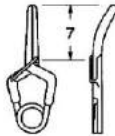
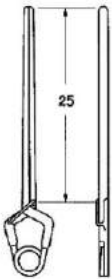

44-601-13 44-601-13 T	44-602-60 44-602-60 T	44-602-68 44-602-68 T	44-602-75 44-602-75 T	44-602-87 44-602-87 T	44-603-55 44-603-55 T	44-603-61 44-603-61 T
13,3 mm 200 gms	6,0 mm 150 gms	6,8 mm 180 gms	7,5 mm 180 gms	8,7 mm 200 gms	5,5 mm 150 gms	6,1 mm 180 gms

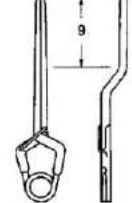
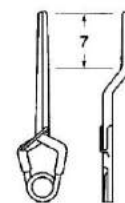
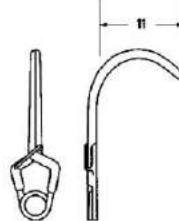
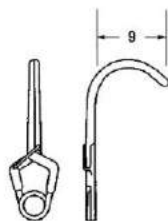
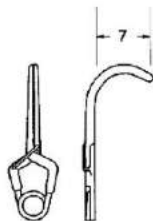
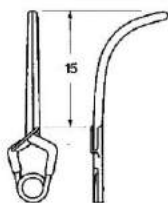
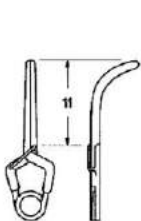

44-603-65 44-603-65 T	44-603-74 44-603-74 T	44-604-54 44-604-54 T	44-604-58 44-604-58 T	44-604-62 44-604-62 T	44-604-79 44-604-79 T	44-604-87 44-604-87 T
6,5 mm 180 gms	7,4 mm 200 gms	5,4 mm 180 gms	5,8 mm 180 gms	6,2 mm 180 gms	7,9 mm 200 gms	8,7 mm 200 gms



## YASARGIL Aneurysm Vessel Clips YASARGIL – Clips para aneurisma

In High Quality Implant Steel Anti-Magnetic  
de acero inoxidable para implantes de alta calidad, antimagnético  
Prodotto in acciaio di alta qualità, antimagnetico

YASARGIL-STANDARD for Permanent Closure  
YASARGIL-STANDARD para cierre permanente  
YASARGIL-STANDARD con chiusura permanente

### Standard

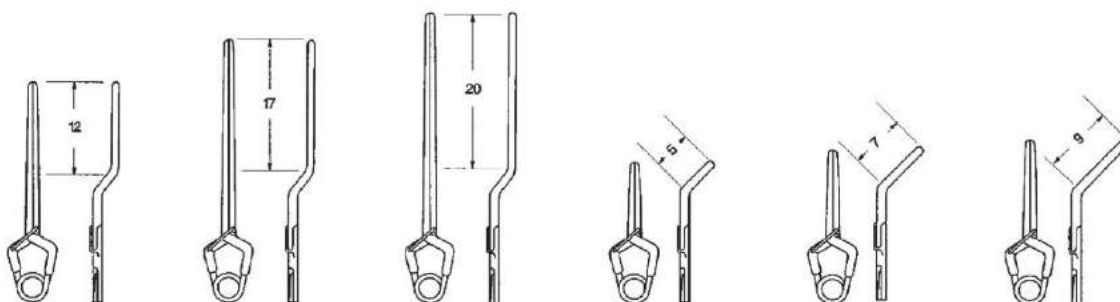

Catalog Number	44-605-10 44-605-10 T	44-605-12 44-605-12 T	44-605-13 44-605-13 T	44-606-62 44-606-62-T	44-606-65 44-606-65 T	44-606-78 44-606-78 T
Max. Opening	10,2 mm 200 gms	11,9 mm 180 gms	13,0 mm 180 gms	6,2 mm 200 gms	6,5 mm 200 gms	7,8 mm 200 gms

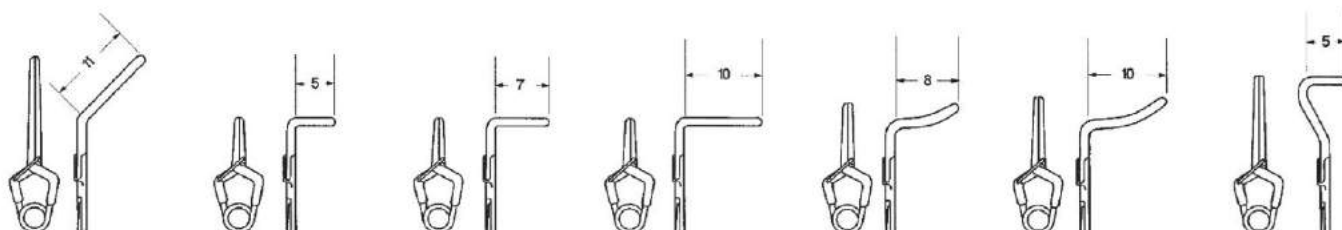

44-606-84 44-606-84 T	44-607-56 44-607-56 T	44-607-57 44-607-57 T	44-607-58 44-607-58 T	44-607-59 44-607-59 T	44-607-60 44-607-60 T	44-607-72 44-607-72 T
8,4 mm 200 gms	5,6 mm 200 gms	5,6 mm 200 gms	5,6 mm 200 gms	5,4 mm 200 gms	5,6 mm 200 gms	7,2 mm 200 gms

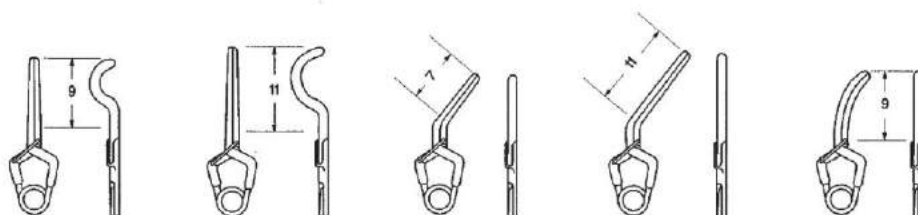

44-607-73 44-607-73 T	44-607-82 44-607-82 T	44-608-57 44-608-57 T	44-608-80 44-608-80 T	44-609-70 44-609-70 T
7,2 mm 200 gms	8,2 mm 200 gms	5,7 mm 200 gms	8,0 mm 200 gms	7,0 mm 200 gms



## YASARGIL Aneurysm Vessel Clips YASARGIL – Clips para aneurisma

In High Quality Implant Steel Anti-Magnetic  
de acero inoxidable para implantes de alta calidad, antimagnético  
Prodotto in acciaio di alta qualità, antimagnetico

YASARGIL-STANDARD for Temporary Closure  
YASARGIL-STANDARD para cierre temporal  
YASARGIL-STANDARD con chiusura temporanea

### Standard

Catalog Number	44-610-70 44-610-70 T	44-610-68 44-610-68 T	44-610-61 44-610-61 T	44-611-92 44-611-92 T	44-611-87 44-611-87 T	44-611-74 44-611-74 T
Max. Opening	7.0 mm 70 gms	6.8 mm 70 gms	6.1 mm 70 gms	9.2 mm 70 gms	8.7 mm 70 gms	7.4 mm 70 gms
	44-612-62 44-612-62 T	44-612-12 44-612-12 T	44-612-11 44-612-11 T	44-612-09 44-612-09 T	44-612-07 44-612-07 T	
	6.2 mm 70 gms	11.4 mm 90 gms	11.0 mm 90 gms	9.9 mm 90 gms	7.5 mm 90 gms	



## YASARGIL Aneurysm Vessel Clips YASARGIL – Clips para aneurisma

In High Quality Implant Steel Anti-Magnetic  
de acero inoxidable para implantes de alta calidad, antimagnético  
Prodotto in acciaio di alta qualità, antimagnetico

YASARGIL-STANDARD for Permanent Closure  
YASARGIL-STANDARD para cierre permanente  
YASARGIL-STANDARD con chiusura permanente

### Standard

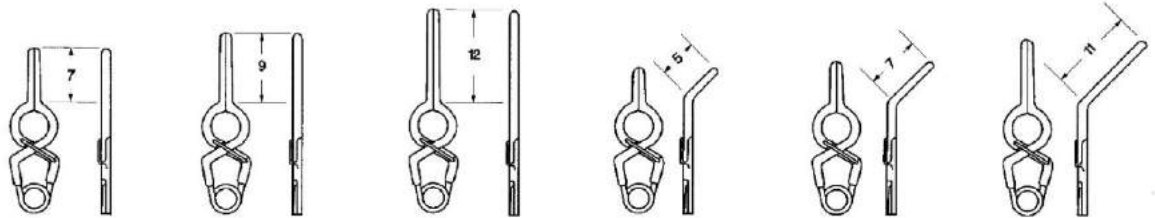

Catalog Number	44-613-74 44-613-74 T	44-613-84 44-613-84 T	44-613-96 44-613-96 T	44-614-58 44-614-58 T	44-614-65 44-614-65 T	44-614-72 44-614-72 T
Max. Opening	7,4 mm 150 gms	8,4 mm 150 gms	9,6 mm 180 gms	5,8 mm 150 gms	6,5 mm 150 gms	7,2 mm 180 gms

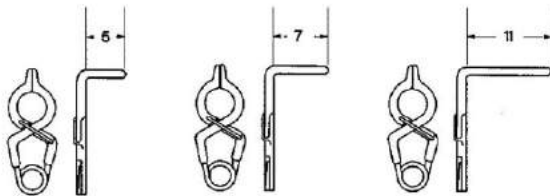

44-615-49 44-615-49 T	44-615-50 44-615-50 T	44-615-51 44-615-51 T
4,9 mm 150 gms	4,9 mm 150 gms	4,9 mm 180 gms





## YASARGIL Aneurysm Vessel Clips YASARGIL – Clips para aneurisma

In High Quality Implant Steel Anti-Magnetic  
de acero inoxidable para implantes de alta calidad, antimagnético  
Prodotto in acciaio di alta qualità, antimagnetico

YASARGIL-STANDARD for Permanent Closure  
YASARGIL-STANDARD para cierre permanente  
YASARGIL-STANDARD con chiusura permanente

### Standard

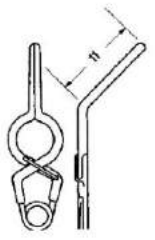
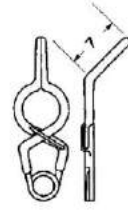
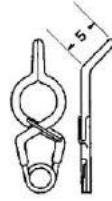
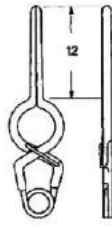
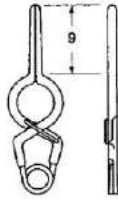
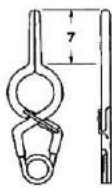

Catalog Number	44-616-79 44-616-79 T	44-616-91 44-616-91 T	44-617-10 44-617-10 T	44-617-65 44-617-65 T	44-617-72 44-617-72 T	44-617-78 44-617-78 T
Max. Opening	7,9 mm 150 gms	9,1 mm 150 gms	10,3 mm 180 gms	6,5 mm 150 gms	7,2 mm 150 gms	7,8 mm 180 gms

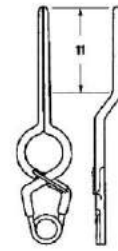
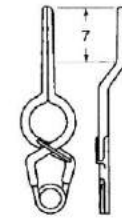
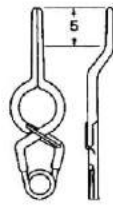
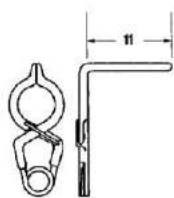
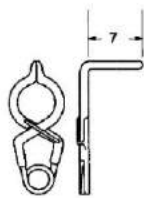
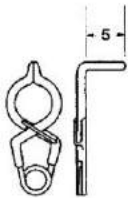

44-618-55 44-618-55 T	44-618-56 44-618-56 T	44-618-57 44-618-57 T	44-618-79 44-618-79 T	44-618-88 44-618-88 T	44-619-00 44-619-00 T
5,5 mm 150 gms	5,5 mm 150 gms	5,5 mm 180 gms	7,9 mm 150 gms	8,8 mm 150 gms	10,0 mm 180 gms



## YASARGIL Aneurysm Vessel Clips YASARGIL – Clips para aneurisma

In High Quality Implant Steel Anti-Magnetic  
de acero inoxidable para implantes de alta calidad, antimagnético  
Prodotto in acciaio di alta qualità, antimagnetico

YASARGIL-STANDARD for Permanent Closure  
YASARGIL-STANDARD para cierre permanente  
YASARGIL-STANDARD con chiusura permanente

### Standard

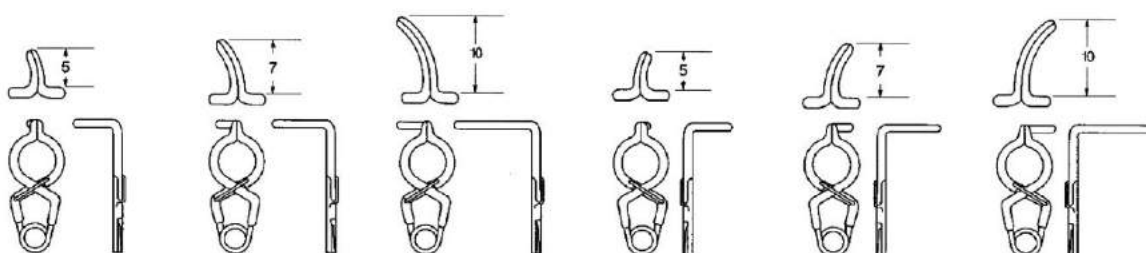

Catalog Number	44-620-58	44-620-59	44-620-60	44-620-61	44-620-62	44-620-63
	<b>44-620-58 T</b>	<b>44-620-59 T</b>	<b>44-620-60 T</b>	<b>44-620-61 T</b>	<b>44-620-62 T</b>	<b>44-620-63 T</b>
Max. Opening	5,8 mm	5,8 mm	5,8 mm	5,8 mm	5,8 mm	5,8 mm
	150 gms	150 gms	150 gms	150 gms	150 gms	150 gms

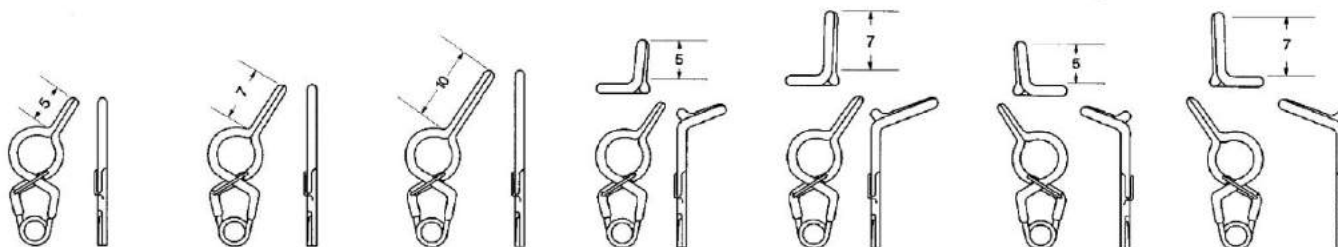

	44-620-70	44-620-78	44-620-88	44-621-58	44-621-62	44-622-58	44-622-62
	<b>44-620-70 T</b>	<b>44-620-78 T</b>	<b>44-620-88 T</b>	<b>44-621-58 T</b>	<b>44-621-62 T</b>	<b>44-622-58 T</b>	<b>44-622-62 T</b>
	7,0 mm	7,8 mm	8,8 mm	5,8 mm	6,2 mm	5,8 mm	6,2 mm
	150 gms	150 gms	150 gms	150 gms	150 gms	150 gms	150 gms

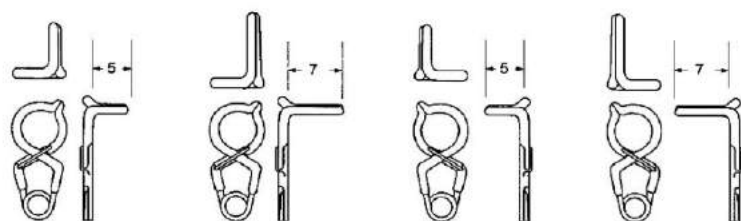

	44-623-56	44-624-56	44-625-56	44-626-56
	<b>44-623-56 T</b>	<b>44-624-56 T</b>	<b>44-625-56 T</b>	<b>44-626-56 T</b>
	5,6 mm	5,6 mm	5,6 mm	5,6 mm
	150 gms	150 gms	150 gms	150 gms



## YASARGIL – Aneurysm Vessel Clips YASARGIL – Clips para aneurisma

In High Quality Implant Steel Anti-Magnetic  
de acero inoxidable para implantes de alta calidad, antimagnético  
Prodotto in acciaio di alta qualità, antimagnetico

YASARGIL-MINI for Permanent Closure  
YASARGIL-MINI para cierre permanente  
YASARGIL-MINI con chiusura permanente

### Mini

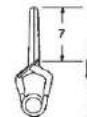
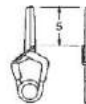
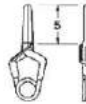

Catalog Number	44-627-33	44-627-40	44-628-33	44-628-40	44-628-46	44-629-32
	44-627-33 T	44-627-40 T	44-628-33 T	44-628-40 T	44-628-46 T	44-629-32 T
Max. Opening	3,3 mm	4,0 mm	3,3 mm	4,0 mm	4,6 mm	3,2 mm
	110 gms	110 gms	110 gms	110 gms	110 gms	110 gms

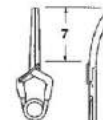
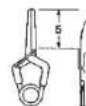
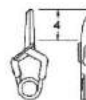
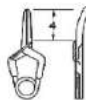

44-629-38	44-630-36	44-630-38	44-631-36	44-631-40	44-631-44	44-632-36
44-629-38 T	44-630-36 T	44-630-38 T	44-631-36 T	44-631-40 T	44-631-44 T	44-632-36 T
3,8 mm	3,6 mm	3,8 mm	3,6 mm	4,0 mm	4,4 mm	3,6 mm
110 gms	110 gms	110 gms	110 gms	110 gms	110 gms	110 gms

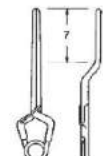
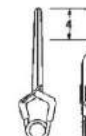
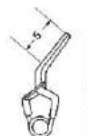
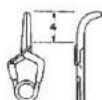

44-633-35	44-633-40	44-634-35	44-634-60	44-634-70	44-635-57	44-636-45
44-633-35 T	44-633-40 T	44-634-35 T	44-634-60 T	44-634-70 T	44-635-57 T	44-636-45 T
3,5 mm	4,0 mm	3,5 mm	6,0 mm	7,0 mm	5,7 mm	4,5 mm
110 gms	110 gms	130 gms	130 gms	130 gms	130 gms	130 gms



## YASARGIL – Aneurysm Vessel Clips YASARGIL – Clips para aneurisma

In High Quality Implant Steel Anti-Magnetic  
de acero inoxidable para implantes de alta calidad, antimagnético  
Prodotto in acciaio di alta qualità, antimagnetico

YASARGIL-MINI for Temporary Closure  
YASARGIL-MINI para cierre temporal  
YASARGIL-MINI con chiusura temporanea

### Mini

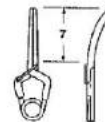
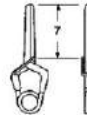

Catalog Number	44-637-33 44-637-33 T	44-637-40 44-637-40 T	44-638-38 44-638-38 T	44-638-46 44-638-46 T	44-639-44 44-639-44 T	44-640-40 44-640-40 T
Max. Opening	3.3 mm 50 gms	4.0 mm 50 gms	3.8 mm 50 gms	4.6 mm 70 gms	4.4 mm 70 gms	4.0 mm 70 gms



## Applying Forceps With Round Shaft – Flexible With and Without Rotation Pinzas de aplicación con mango redondo – Flexible – con y sin rotación

Length		
Largo		
Lunghezza	MINI	STANDARD
70 mm	44-641-07	44-643-07
90 mm	44-641-09	44-643-09
110 mm	44-641-11	44-643-11

Non Rotating  
sin rotación  
non rotante

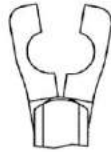

Length		
Largo		
Lunghezza	MINI	STANDARD
70 mm	44-642-07	44-644-07
90 mm	44-642-09	44-644-09
110 mm	44-642-11	44-644-11

Rotating  
rotante  
rotante

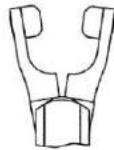

Rotating  
rotante  
rotante

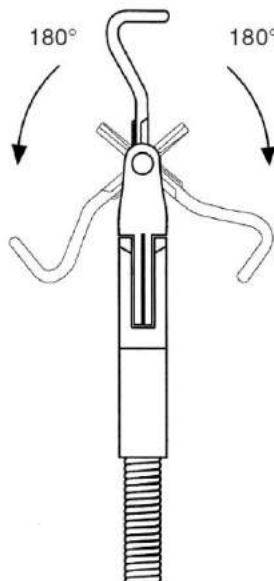

Example for Rotation  
Ejemplo de la rotación  
Esempio della rotazione

Clips Rotatable in Jaw  
Clips rotabile en la boca  
Clips rotabile nel morso

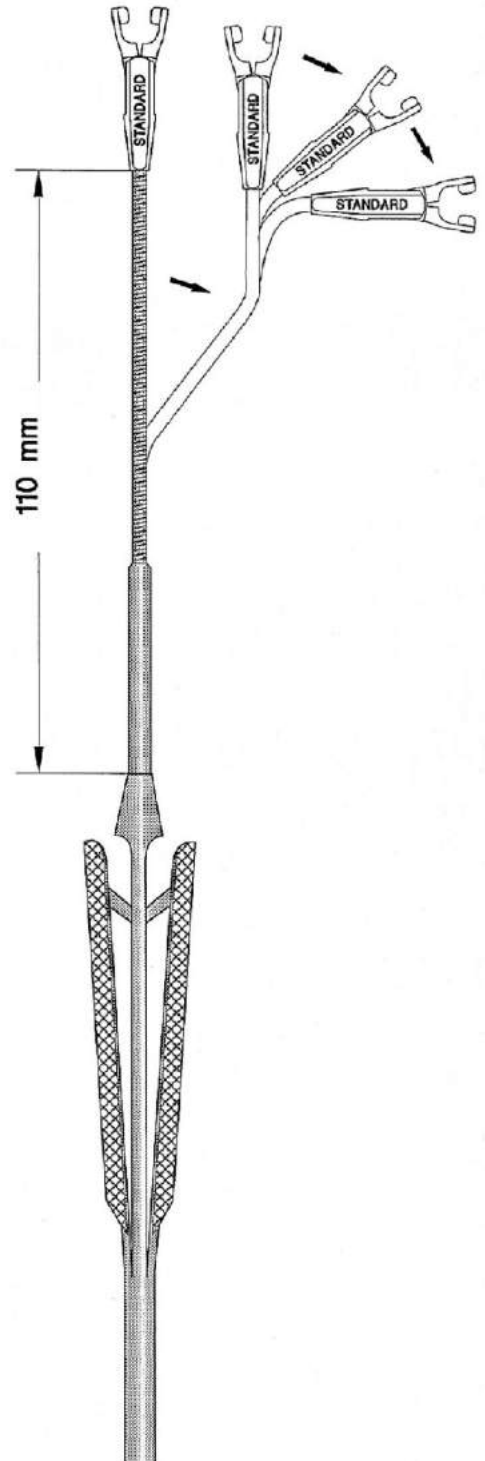

44-641-07 to 44-644-11



## Applying Forceps With Round Shaft – Rigid With and Without Rotation Pinzas de aplicación con mango redondo – rígido – con y sin rotación

Length		
Largo		
Lunghezza	MINI	STANDARD
70 mm	44-645-07	44-647-07
90 mm	44-645-09	44-647-09
110 mm	44-645-11	44-647-11

Non Rotating  
sin rotación  
non rotante

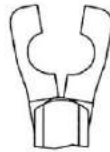

Length		
Largo		
Lunghezza	MINI	STANDARD
70 mm	44-646-07	44-648-07
90 mm	44-646-09	44-648-09
110 mm	44-646-11	44-648-11

Rotating  
rotante  
rotante

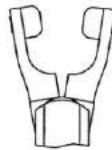

Rotating  
rotante  
rotante

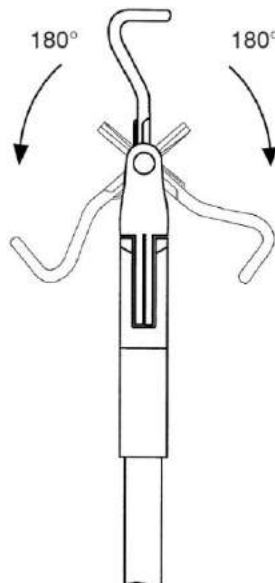

Example for Rotation  
Ejemplo de la rotación  
Esempio della rotazione

Clips Rotatable in Jaw  
Clips rotabile en la boca  
Clips rotabile nel morso

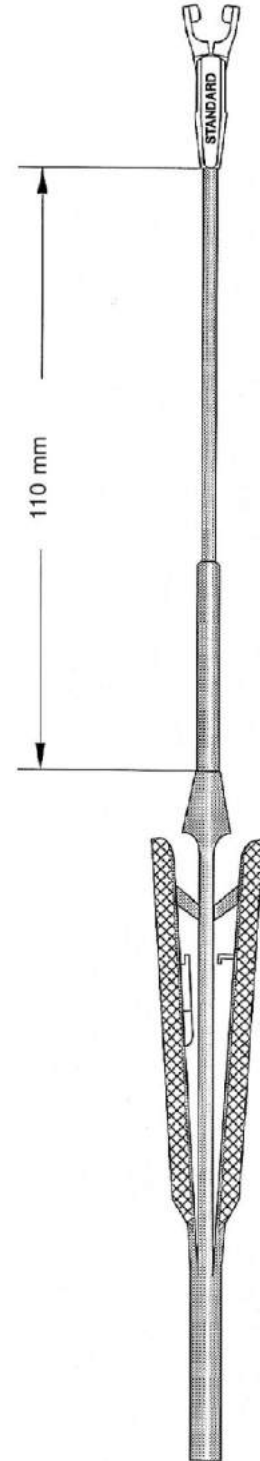

44-645-07 to 44-648-11



## Applying Forceps With Round Shaft – Rigid With and Without Rotation Pinzas de aplicación con mango redondo – rígido – con y sin rotación

Length Largo Lunghezza	MINI	STANDARD
70 mm	44-649-07	44-651-07
90 mm	44-649-09	44-651-09
110 mm	44-649-11	44-651-11

Non Rotating  
sin rotación  
non rotante

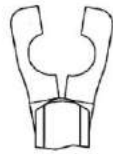

Length Largo Lunghezza	MINI	STANDARD
70 mm	44-650-07	44-652-07
90 mm	44-650-09	44-652-09
110 mm	44-650-11	44-652-11

Rotating  
rotante  
rotante

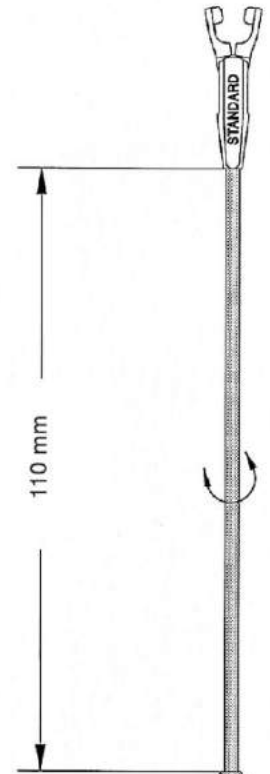
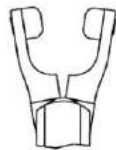

Rotating  
rotante  
rotante

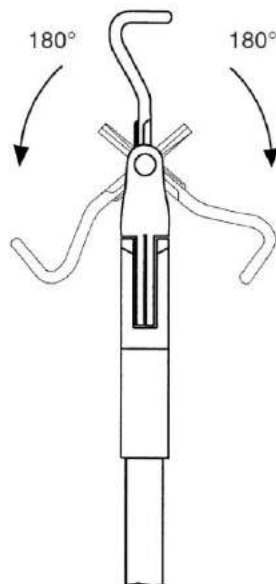

Example for Rotation  
Ejemplo de la rotación  
Esempio della rotazione

Clips Rotatable in Jaw  
Clips rotabile en la boca  
Clips rotabile nel morso

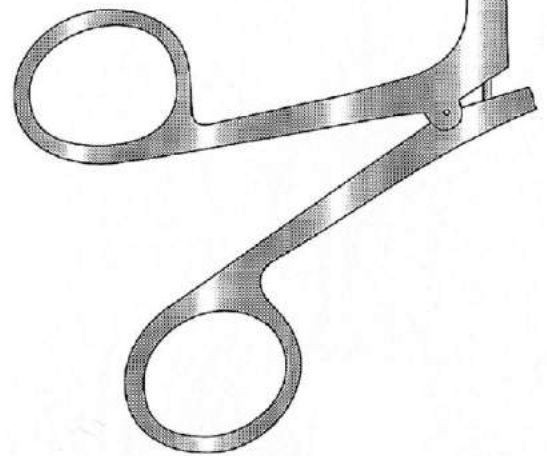

44-649-07 to 44-652-11



## Applying Forceps – With and Without Rotation Pinzas de aplicación, con y sin rotación

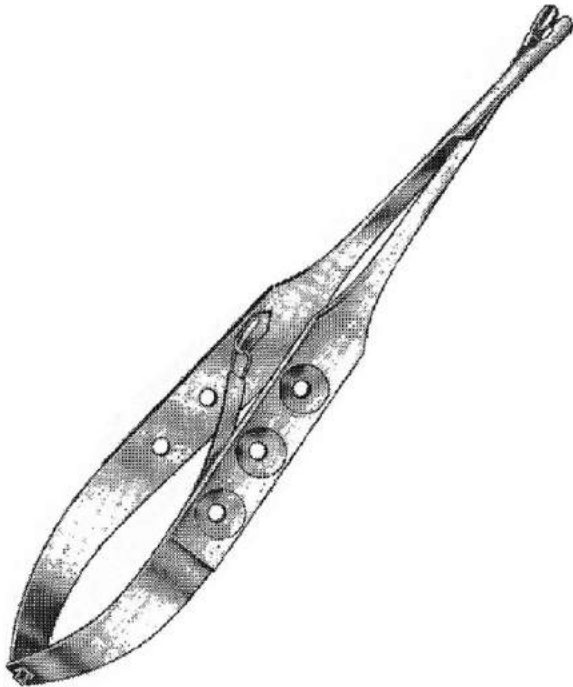

MINI	44-653-18	
STANDARD	44-654-18	
MINI	44-655-18	Rotating rotante / rotante
STANDARD	44-656-18	Rotating rotante / rotante

Applying Forceps Straight, with Ratchet, Length 18 cm, 7"  
Pinza de aplicación, con cremallera, 18 cm, 7"  
Posa clips, retta con bloccaggio lunghezza 18 cm, 7"

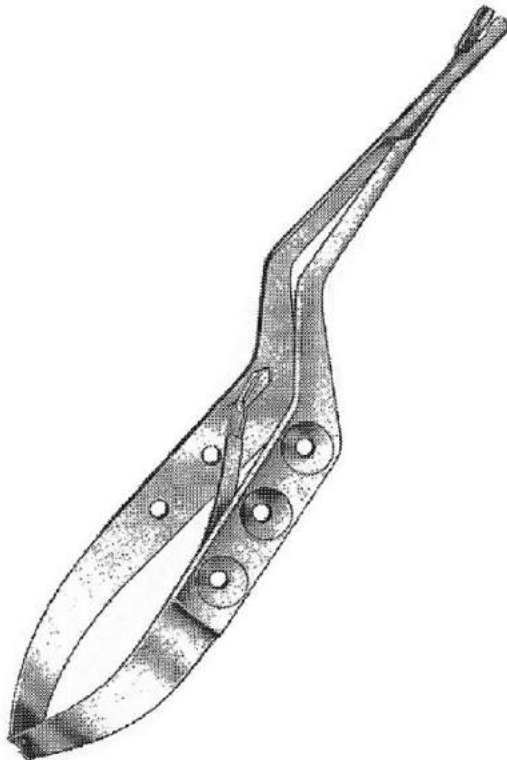

Length			
Largo			
Lunghezza	17 cm, 6 3/4"	21 cm, 8 1/4"	23 cm, 9"
MINI	44-657-17	44-657-21	44-657-23
STANDARD	44-658-17	44-658-21	44-658-23
MINI	44-659-17	44-659-21	44-659-23
	Rotating / rotante / rotante		
STANDARD	44-660-17	44-660-21	44-660-23
	Rotating / rotante / rotante		



Clips Rotatable in Jaw  
Clips rotabile en la boca  
Clips rotabile nel morso

Applying Forceps Bayonet, with Ratchet  
Pinza de aplicación, forma de bayoneta,  
con cremallera  
Posa clips a baionetta con bloccaggio





## BIEMER Vessel Clips Clips para vasos de BIEMER

	Opening	Length of Jaw	Closing Force
 44-661-40	Apertura de la boca Apertura del morso 4.0 mm	Largo de la boca Lunghezza del morso 6.0 mm	Fuerza de cierre Forza di chiusura 30 - 40 g (0.29 - 0.39 N)
 44-661-50	5.0 mm	9.0 mm	30 - 40 g (0.29 - 0.39 N)
 44-662-50	5.0 mm	9.0 mm	20 - 25 g (0.20 - 0.25 N)

### For Temporary Occlusion

Identified by yellow colored spring ends - for vessel diam. 0.5 - 2.0 mm.

Blade gripping surface with oblique serrations for safe but careful gripping of vessels.

No risk due to rigidly fixed pressure measure.

### para uso temporal

clips marcados con baño dorado en los resortes, para vasos con un diámetro de 0,5 - 2,0 mm

El interior de las quijadas viene con estrias finas para un agarre seguro y cuidadoso de los vasos

Debido a la calibración exacta de la fuerza de cierre se ofrece una aplicación sin riesgo

### per chiusura temporanea

per vasi con Diametro 0,5 - 2,0 mm

La chiusura regolata garantisce nessun rischio

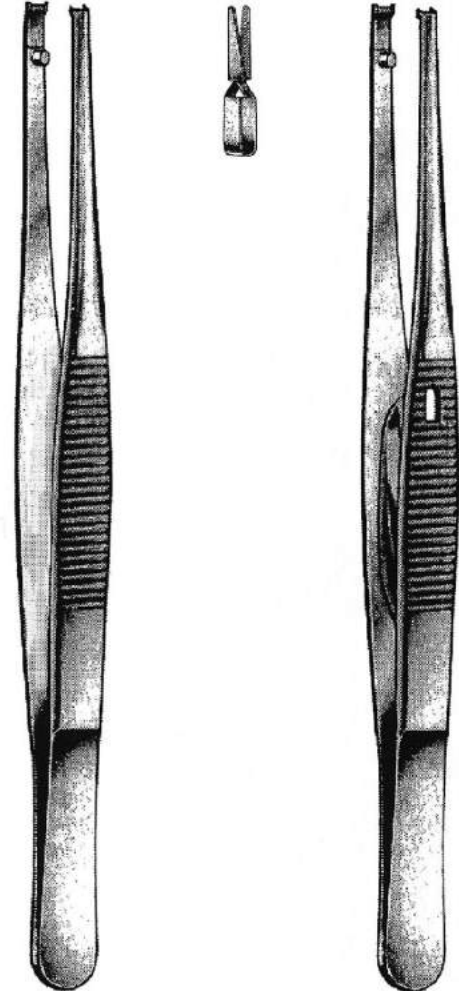

BIEMER  
44-663-01

BIEMER  
44-663-02

Applying Forceps Without Lock.  
For vessel clips  
44-661-40 to 44-662-50  
and  
Aproximators  
44-667-30 to 44-670-50  
and  
44-672-01 to 44-672-04

Applying Forceps With Lock.  
For vessel clips  
44-661-40 to 44-662-50  
and  
Aproximators  
44-667-30 to 44-670-50  
and  
44-672-01 to 44-672-04



## MEHDORN Vessel Clips Clips para vasos de MEHDORN

### For Temporary Occlusion

Identified by yellow colored spring ends - for vessel diam. 0.5 - 1.5 mm.

Blade gripping surface with oblique serrations for safe but careful gripping of vessels.

No risk due to rigidly fixed pressure measure.

### para uso temporal

clips marcados con baño dorado en los resortes, para vasos con un diámetro de 0.5 - 1.5 mm

El interior de las quijadas viene con estrias finas para un agarre seguro y cuidadoso de los vasos

Debido a la calibración exacta de la fuerza de cierre se ofrece una aplicación sin riesgo

### per chiusura temporanea

per vasi con Diametro 0,5 - 1,5 mm

La chiusura regolata garantisce nessun rischio

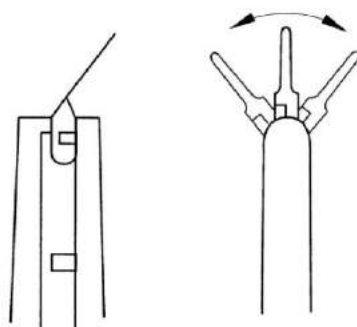



MEHDORN  
44-666-00

Applying Forceps for vessel clips  
44-664-10 to 44-665-14

Pinza de aplicación para micro-clips  
44-664-10 to 44-665-14

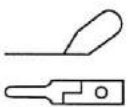
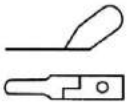
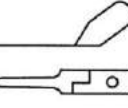
Pinza posa clips per microvasi  
44-664-10 to 44-665-14

	Length of Jaw Largo de la boca Lunghezza del morso	Closing Force Fuerza de cierre Forza di chiusura
	44-664-10 4 x 1.0 mm	10 - 15 g (0.10 - 0.15 N)
	44-664-14 4 x 1.4 mm	15 - 20 g (0.15 - 0.20 N)
	44-665-10 6 x 1.0 mm	10 - 15 g (0.10 - 0.15 N)
	44-665-14 6 x 1.4 mm	15 - 20 g (0.15 - 0.20 N)

## BIEMER Approximators Aprossimatore secondo Biemer-Müller

### For Temporary Occlusion

(identified by yellow coloured spring ends) for vessel diam. 0,5 - 2,0 mm  
Blade gripping surface with oblique serrations for safe but careful gripping of vessels  
No risk due to rigidly fixed pressure measure

### para uso temporal

clips marcados con baño dorado en los resortes, para vasos con un diámetro de 0,5 - 2,0 mm  
El interior de las quijadas viene con estrias finas para un agarre seguro y cuidadoso de los vasos  
Debido a la calibración exacta de la fuerza de cierre se ofrece una aplicación sin riesgo

### per chiusura temporanea

per vasi con Diametro 0,5 - 2,0 mm  
La chiusura regolata garantisce nessun rischio

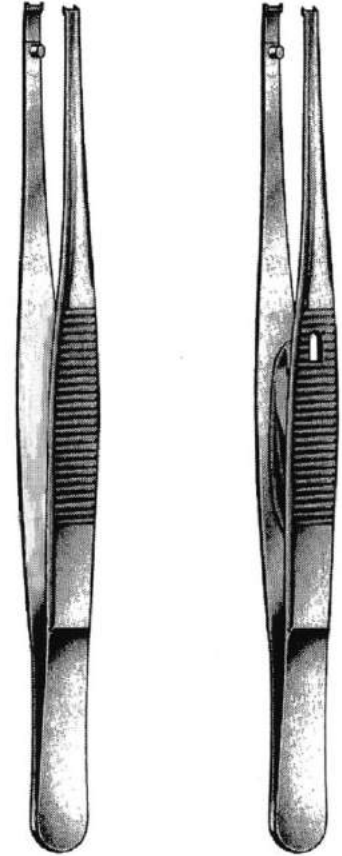

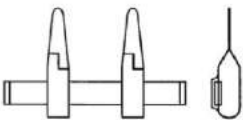
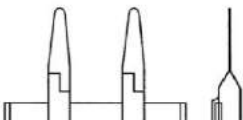
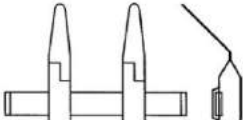
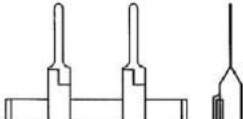
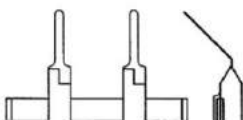
	Opening Apertura de la boca Apertura del morso	Length of Jaw Largo de la boca Lunghezza del morso	Closing Force Fuerza de cierre Forza di chiusura
 44-667-30	3.0 mm	4.5 mm	30 - 40 g (0.29 - 0.39 N)
 44-667-50	5.0 mm	9.0 mm	30 - 40 g (0.29 - 0.39 N)
 44-668-50	5.0 mm	9.0 mm	30 - 40 g (0.20 - 0.25 N)
 44-669-50	5.0 mm	9.0 mm	30 - 40 g (0.20 - 0.25 N)
 44-670-50	5.0 mm	9.0 mm	30 - 40 g (0.20 - 0.25 N)

BIEMER  
44-663-01

BIEMER  
44-663-02

Applying Forceps Without Lock.  
For vessel clips  
44-661-40 to 44-662-50  
and  
Aproximators  
44-667-30 to 44-670-50  
and  
44-672-01 to 44-672-04

Applying Forceps With Lock.  
For vessel clips  
44-661-40 to 44-662-50  
and  
Aproximators  
44-667-30 to 44-670-50  
and  
44-672-01 to 44-672-04



## MUELLER Approximators Aproximadores de Müller

### For Temporary Occlusion

(identified by yellow coloured spring ends) for vessel diam. 0,5 - 2,0 mm  
Blade gripping surface with oblique serrations for safe but careful gripping of vessels  
No risk due to rigidly fixed pressure measure

### para uso temporal

clips marcados con baño dorado en los resortes, para vasos con un diámetro de 0,5 - 2,0 mm  
El interior de las quijadas viene con estrias finas para un agarre seguro y cuidadoso de los vasos  
Debido a la calibración exacta de la fuerza de cierre se ofrece una aplicación sin riesgo

### per chiusura temporanea

per vasi con Diametro 0,5 - 2,0 mm  
La chiusura regolata garantisce nessun rischio

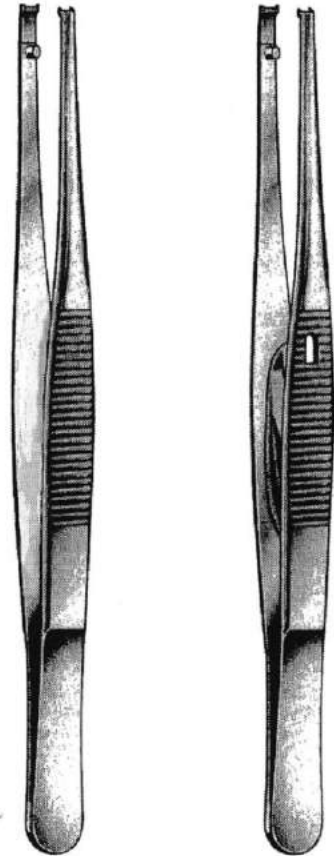

	Ø Diameter	Closing Force Fuerza de cierre Forza di chiusura
44-672-01	1.0 mm	25 - 30 g (0.25 - 0.29 N)
44-672-02	2.0 mm	25 - 30 g (0.25 - 0.29 N)
44-672-03	3.0 mm	25 - 30 g (0.25 - 0.29 N)
44-672-04	4.0 mm	25 - 30 g (0.25 - 0.29 N)

BIEMER  
44-663-01

BIEMER  
44-663-02

Applying Forceps Without  
Lock.  
For vessel clips  
44-661-40 to 44-662-50  
and  
Approximators  
44-667-30 to 44-670-50  
and  
44-672-01 to 44-672-04

Applying Forceps With  
Lock.  
For vessel clips  
44-661-40 to 44-662-50  
and  
Approximators  
44-667-30 to 44-670-50  
and  
44-672-01 to 44-672-04



## MUELLER Vessel Clips Clips para vasos de Müller

### For Temporary Occlusion

Blade gripping surface with pyramid-like impressions for safe but careful gripping of vessels

No risk due to rigidly fixed pressure measure

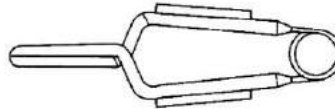

44-674-50

Closing Force  
Fuerza de cierre  
Forza di chiusura

50 g

### para uso temporal

El interior de las quijadas viene en forma de pirámide para un agarre seguro y cuidadoso de los vasos

Debido a la calibración exacta de la fuerza de cierre se ofrece una aplicación sin riesgo



44-674-80

80 g

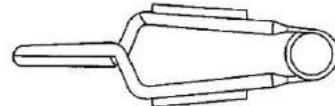

44-675-50

50 g

### per uso temporaneo

Morso interno con forma piramidale per garantire una chiusura sicura del vaso

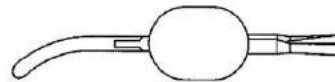

44-675-80

80 g

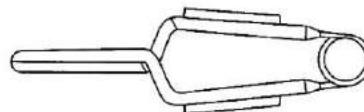

44-676-50

50 g



44-676-80

80 g

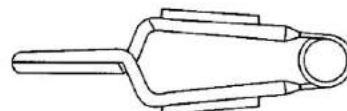

44-677-50

50 g

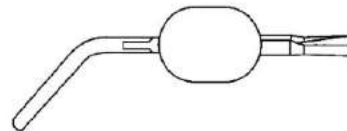

44-677-80

80 g

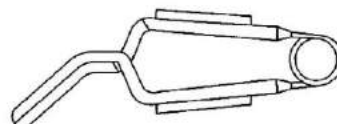

44-678-50

50 g



44-678-80

80 g



## BIEMER Approximator Aproximadores de Biemer

For Micro Vessel Anastomosis. Clamp features uniform fixed pressure.

Blade gripping surface with oblique serrations for safe but careful gripping of vessels.

No risk due to uniformly fixed pressure measurement.

Distance between clips is adjustable automatically by tilting.

### Para micro-anastomosis en la superficie

El interior de la qui jada viene con estrias finas para un agarre seguro y cuidadoso de los vasos.

Debido a la calibración exacta de la fuerza de cierre se ofrece una aplicación sin riesgo.

El espacio entre los clips se logra fácilmente por el desplazamiento.

### Per micro vasi anastomosi sulla parte della superficie

Parte interna del morso è leggermente striata obliqua per ottenere la presa sulla superficie del vaso.

La chiusura regolata garantisce nessun rischio.

Lo scorrimento delle due clips viene regolato con semplice movimento che consente una chiusura ottimale.

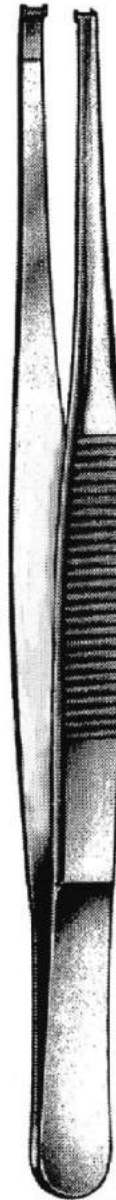

BIEMER  
44-680-00

Applying Forceps for BIEMER  
vessel approximator

Pinza de aplicación para  
aproximadores de BIEMER

Pinza posa clips per vasi  
aprossimatori secondo  
BIEMER

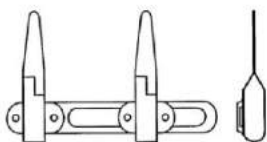

44-679-25

Closing Force  
Fuerza de cierre  
Forza di chiusura

25 - 30 g  
(0.25 - 0.29 N)



## LEYLA Retractor System LEYLA Sistema di Fissaggio

- 44-843-43 Ball and Socket Joint for Fixation on Operating Table 10 x 25 mm  
Zapato para la fijación del brazo, articulado  
Giunto per fissare il braccio, articolato
- 44-850-41 Holding Rod for Fixation  
Brazo de fijación / Braccio di fissaggio
- 44-842-42 Coupling Head for 5 Flexible Arms Maximum  
Pieza de combinación para 5 brazos máx.  
Giunto per combinare 5 bracci mass.
- 44-842-44 Coupling Head, Turnable, Alternative to 44-842-42  
Pieza de combinación giratoria para 44-842-42  
Giunto per combinare girevole per 44-842-42
- 44-842-46 Coupling Head, Laterally Open, Alternative to 44-842-42  
Giunto per fissare il braccio, alternativa per 44-842-42
- 44-810-10 Flexible Arm / Brazo flexible suelto / Braccio flessibile solo
- 44-830-30 Holder for Flat Brain Spatula  
Soporte para espátulas llanas / Sostegno per spatole piatte
- 44-880-02 Brain Spatula / Spatola cerebrale

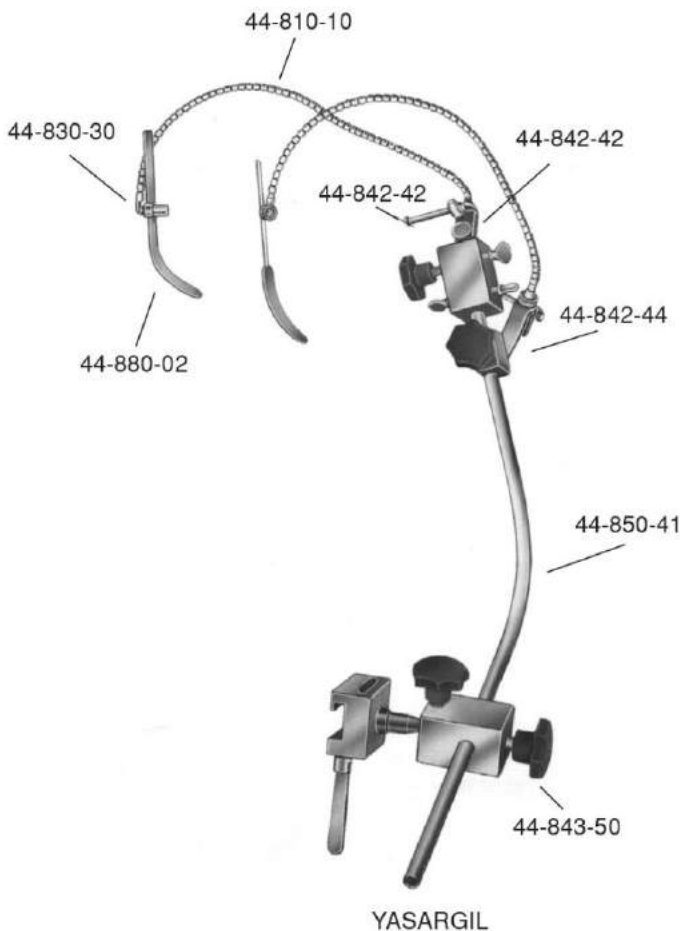
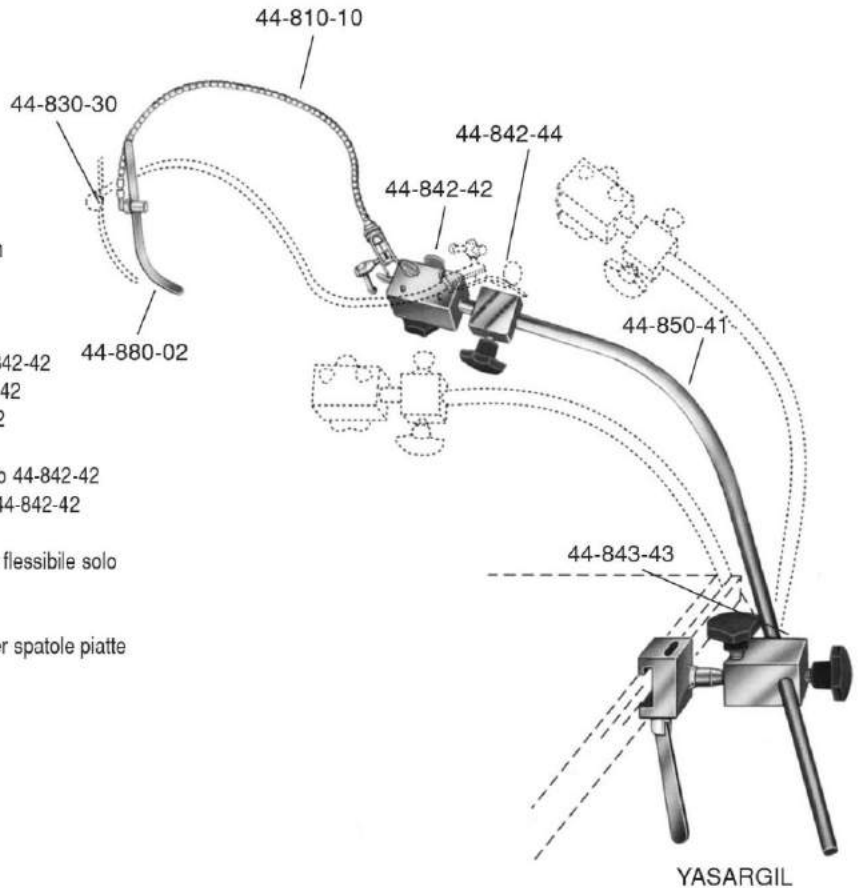

- 44-843-50 Ball and Socket Joint for Fixation on Operating Table 9 x 32 mm  
Giunto per fissare il braccio, articolato 9 x 32 mm
- 44-850-41 Holding Rod for Fixation  
Brazo de fijación / Braccio di fissaggio
- 44-842-42 Coupling Head for 5 Flexible Arms Maximum  
Pieza de combinación para 5 brazos máx.  
Giunto per combinare 5 bracci mass.
- 44-842-44 Coupling Head, Turnable, Alternative to 44-842-42  
Pieza de combinación giratoria para 44-842-42  
Giunto per combinare girevole per 44-842-42
- 44-842-46 Coupling Head, Laterally Open, Alternative to 44-842-42  
Giunto per fissare il braccio, alternativa per 44-842-42
- 44-810-10 Flexible Arm  
Brazo flexible suelto / Braccio flessibile solo
- 44-830-30 Holder for Flat Brain Spatula  
Soporte para espátulas llanas / Sostegno per spatole piatte
- 44-880-02 Brain Spatula / Spatola cerebrale



## LEYLA Retractor System LEYLA Sistema di Fissaggio



44-801-01 Brain Retractor, Flexible, for Flat Spatula, with 1 Flexible Arm, Complete, consisting of:  
Separador autorretentivo, flexible, para espátulas llanas, con 1 brazo flexible, completo, compuesto de:  
Divaricatore autostatico, flessibile, per spatole piatte, con 1 braccio flessibile, completo, composto da:

44-821-21 Fixation Base for 1 Flexible Arm  
Fijador para 1 brazo al brazo rígido / Fissatore per 1 braccio al braccio rigido

44-810-10 Flexible Arm Only  
Brazo flexible suelto / Braccio flessibile solo

44-830-30 Holder for Flat Brain Spatula  
Soporte para espátulas llanas / Sostegno per spatole piatte

44-802-02 Brain Retractor, Flexible, for Flat Spatulas, with 2 flexible arms, complete, consisting of:  
Separador, autorretentivo, flexible, para espátulas llanas, con 2 brazos flexibles, completo, compuesto de:  
Divaricatore autostatico, flessibile, per spatole piatte, con 2 bracci flessibili, completo, composto da:

44-822-22 Fixation Base for 2 Flexible Arms  
Fijador para 2 brazos al craneo / Fissatore per 2 bracci al cranio

44-820-10 Flexible Arm Only (2x)  
Brazo flexible suelto (2x) / Braccio flessibile solo (2x)

44-830-30 Support for Flat Brain Spatulas (2x)  
Soporte para espátulas llanas (2x) / Sostegno per spatole piatte (2x)



44-810-10 Flexible Arm  
Brazo flexible suelto / Braccio flessibile solo

44-803-01 Ear Specula Holder Complete, Consisting of:  
Sostegno per specolo auricolare, completo composto da:

44-810-10 Flexible Arm Only  
Brazo flexible suelto / Braccio flessibile solo

44-821-23 Clamp for Fixation on Bars up to Ø 16 mm  
Fissatore al braccio rigido Ø 16 mm

44-807-00 Ear Specula Holder Only  
Soporte para espéculo de oídos / Sostegno per specolo auricolare

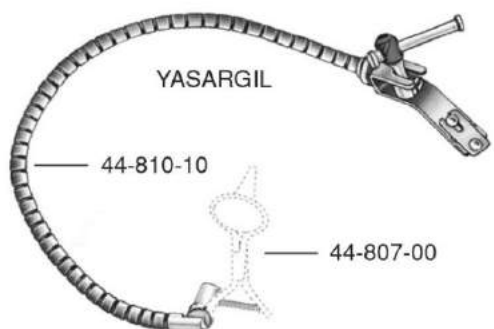

44-830-30 Support for Flat Brain Spatula  
Soporte para espátulas llanas  
Sostegno per spatole piatte

44-832-32 Support for Brain Spatula with round shaft



44-822-22 Fixation for 2 Arms at Skull  
Fijador para 2 brazos al craneo  
Fissatore per 2 bracci al cranio



44-826-26 Fixation for 1 Arm at Skull  
Fijador para 1 brazo al craneo  
Fissatore per 1 braccio al cranio



44-821-21 Fixation Base for 1 Arm on Bars  
Fijador para 1 brazo al brazo rígido  
Fissatore per 1 braccio al braccio rigido





Brain Spatulas  
Spatole Cerebrali



HEIFETZ  
200 mm  
8"

	Width Larghezza	Blade Length Lunghezza totale
44-860-14	14 mm	200 mm
44-860-17	17 mm	200 mm
44-860-20	20 mm	200 mm
		Malleable malleabile



HEIFETZ  
155 mm  
6"

	Width Larghezza	Blade Length Lunghezza totale
44-870-08	8 mm	155 mm
44-870-11	11 mm	155 mm
44-870-14	14 mm	155 mm
44-870-17	17 mm	155 mm
		Malleable malleabile

	Width Larghezza	Total length Lunghezza totale
44-880-01	9 mm	200 mm
44-880-02	12 mm	200 mm
44-880-03	12 mm	250 mm
		Malleable malleabile



CUSHING  
200 mm, 8"



## Eye Specula Blefaróstatos

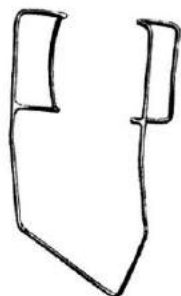

**BARRAQUER (Colibri)**

46-101-03 3 cm, 1.2" Children / niños / bambini  
46-101-04 4 cm, 1.6" Adults / adultos / adulti



**BOWMAN**

46-104-07  
7 cm, 2 3/4"

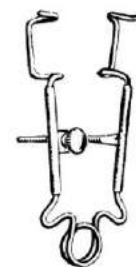

**CRITCHETT**

46-105-06  
7 cm, 2 3/4"



**SMITH**

46-106-05  
5 cm, 2"



**CLARK**

46-107-08  
8 cm, 3 1/8"



**GRAEFE**

46-109-07 7 cm, 2 3/4"  
46-109-09 9 cm, 3 1/2"



**WEEK**

46-110-08  
8 cm, 3 1/8"

Right  
a la derecha  
destro

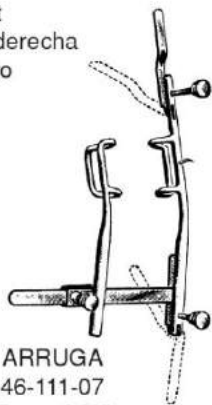

**ARRUGA**  
46-111-07  
7 cm, 2 3/4"

Left  
a la izquierda  
sinistro

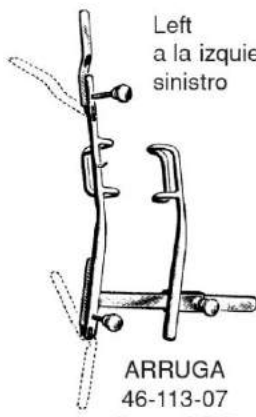

**ARRUGA**  
46-113-07  
7 cm, 2 3/4"



**MURDOCK**  
46-115-05  
5 cm, 2"



**MELLINGER-AXENFELD**  
46-121-07  
7 cm, 2 3/4"



**MELLINGER-AXENFELD**  
46-123-07  
7 cm, 2 3/4"



**MELLINGER**  
46-125-05 5 cm, 2"  
46-125-07 7 cm, 2 3/4"



**LISTER-BURCH**  
46-127-08  
8 cm, 3 1/8"



**WILLIAMS**  
46-128-08  
8 cm, 3 1/8"



## Eye Specula, Lid Plate, Cataract Knives Blefaróstatos, Placa para párpados, cuchillos para catarata



LANCASTER  
46-129-07  
7 cm, 2 3/4"



ZIEGLER  
46-130-07  
7 cm, 2 3/4"



CASTROVIEJO  
46-132-08  
8 cm, 3 1/8"

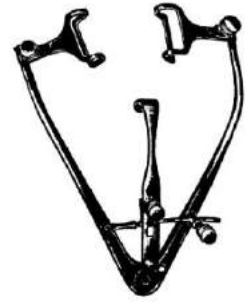

PARK  
46-133-08  
8 cm, 3 1/8"



MUELLER  
46-135-07  
7 cm, 2 3/4"



STEVENSON  
46-139-07  
7 cm, 2 3/4"



LIEBERMAN  
46-140-08  
8 cm 3 1/8"



LIEBERMAN  
46-141-08  
8 cm 3 1/8"



JAEGER  
46-150-11  
11 cm, 4 3/8"



GRAEFE  
46-170-00 to 46-170-03



46-170-00



46-170-01



46-170-02



46-170-03



DEUTSCHMAN  
46-172-13  
13 cm, 5 1/8"



## Cataract Knife, Keratome, Iris Knife, Discission Knife Cuchillos lanceolares y Cuchillos de discisión



46-180-01 to  
46-181-03



46-180-01  
Fig. 1



JAEGER  
46-180-02  
Fig. 2



46-180-03  
Fig. 3



46-181-01  
Fig. 1



JAEGER 45°  
46-181-02  
Fig. 2



46-181-03  
Fig. 3



BERENS  
46-183-13  
13 cm, 5 1/8"



CASTROVIEJO  
46-185-13 13 cm  
4 x 13 mm



GRAEFE  
46-187-13  
13 cm, 5 1/8"



46-202-01  
Fig. 1



KNAPP  
46-202-02  
Fig. 2



46-202-03  
Fig. 3



ZIEGLER  
46-210-01 5 mm  
Fig. 1



ZIEGLER  
46-210-02 6 mm  
Fig. 2



ZIEGLER  
46-210-03 7 mm  
Fig. 3



DEAN  
46-213-12  
12.5 cm, 5"



BOWMAN  
46-214-04 13 cm  
4 mm Blade



BOWMAN  
46-214-08 13 cm  
8 mm Blade



Corneal Knife, Dissector, Sclerotome, Goniotomy Knife  
Cuchillos para cornea, legbras corneales, esclerótomos



WHEELER  
46-218-12  
12 cm, 4 3/4"



ZIEGLER  
46-221-11  
11 cm, 4 3/8"  
3.5 mm



SATO  
46-226-12  
12.5 cm, 5"



TOOK  
46-228-12  
12 cm, 4 3/4"



GILL  
46-231-12  
12 cm, 4 3/4"



ELSCHNIG  
46-233-13  
13 cm, 5 1/8"



KUHNT  
46-240-01  
Fig. 1



KUHNT  
46-240-02  
Fig. 2



KUHNT  
46-240-03  
Fig. 3



KUHNT  
46-240-04  
Fig. 4



PATON  
46-245-12  
12 cm, 4 3/4"



LUNDSGAARD  
46-251-12  
12 cm, 4 3/4"



GUYTON-  
LUNDSGAARD  
46-253-12



BARKAN  
46-256-12



SCHEIE  
46-258-12



BURCH  
46-262-12



PAUFIQUE  
46-271-11



BARRAQUER  
46-273-13



## Discission Needles, Foreign Body Instruments Agujas de discisión, Instrumental para cuerpos extraños



Cataract  
46-304-12



Cataract  
46-305-12



BOWMAN  
46-308-12



BOWMAN  
46-309-12



Foreign Body  
46-310-13



46-311-13



LEVINSON  
46-314-13



FRANCIS  
46-321-12



DAVIS  
46-325-13



LA FORCE  
46-327-12



DIX  
46-330-13



ELLIS  
46-331-11



WALTON  
46-332-12  
1.4 mm



WALTON  
46-334-12  
1.4 mm



ALVIS  
46-336-12

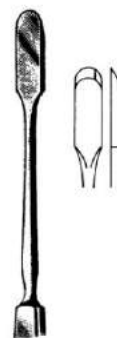

GREEN  
46-340-13

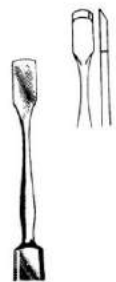

ROLLET  
46-342-12



## Strabismus Hooks, Iris Hooks, Retractors Ganchos para estrabismo, - cristallino, extracción



Fig. 1  
GRAEFE  
46-351-01



Fig. 2  
GRAEFE  
46-351-02



Fig. 3  
GRAEFE  
46-351-03



JAMESON  
46-353-13



GREEN  
46-355-13



STEVENS  
46-357-13



Fig. 1  
ARRUGA  
46-363-01



Fig. 2  
ARRUGA  
46-363-02



O'CONNOR  
46-370-12



WIENER  
46-372-13



WIENER  
46-373-13



ROLLET  
46-376-13



KNAPP  
46-377-13



GRAEFE  
46-380-13



GRAEFE  
46-381-13



GRAEFE  
46-383-13



BECKER  
46-386-13



Instruments for Implantation  
Instrumentos para implantación

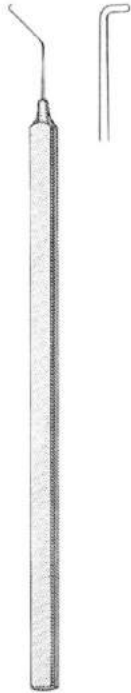

CLAYMAN  
46-387-02  
11.5 cm 4 1/2"



SINSKEY  
46-388-02  
11.4 cm 4 1/2"



SINSKEY  
46-389-02  
12 cm 4 3/4"

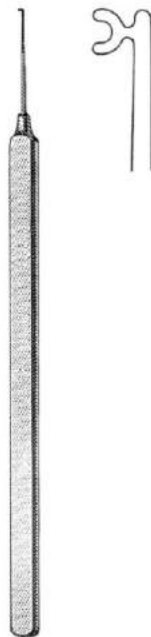

KUGLEN  
46-390-05  
11.7 cm 4 5/8"

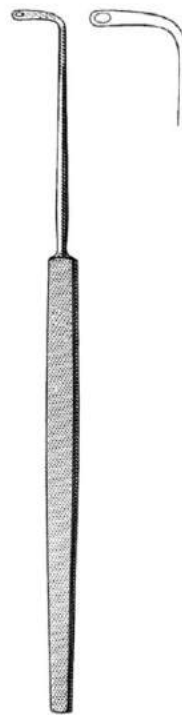

GASS  
46-391-13  
14.6 cm 5 3/4"





## Scoops and Curettes for Chalazion, Cataract, and Evisceration Curetas y cucharillas para chalazión, catarata y exenteración

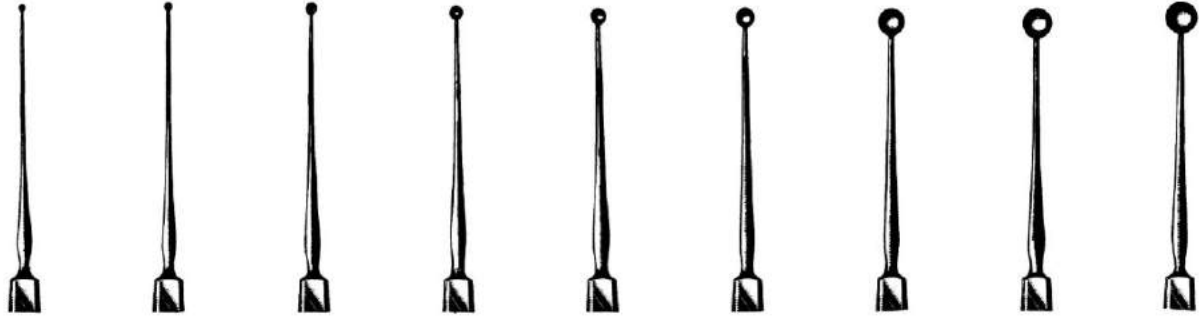

MEYHOEFER  
46-402-05 to 46-402-45

46-402-05	46-402-10	46-402-15	46-402-18	46-402-20	46-402-25	46-402-35	46-402-40	46-402-45
Ø mm 0.5	1.0	1.5	1.8	2.0	2.5	3.5	4.0	4.5



HEBRA 46-404-10	HEBRA 46-404-20	HEBRA 46-404-24	HEBRA 46-404-30	HEBRA 46-404-35
Ø mm 1.0	2.0	2.5	3.0	3.5



AXENFELD  
46-407-13



GRAEFE  
46-410-01



GRAEFE  
46-410-02



DAVIEL  
46-412-01  
3 mm



DAVIEL  
46-412-02  
4 mm



Cataract Spoon, Evisceration Scoops, Lens Scoops, Spatulas, Protectors  
 Cucharillas para Catarata-, exenteración, Asas, Espátulas, Protectores



KNAPP  
46-414-02



BUNGE  
46-420-01



BUNGE  
46-420-02



BUNGE  
46-420-03



LANG  
46-424-13



WEBER  
46-441-01 Fig. 1



46-441-02  
Fig. 2



SNELLEN  
46-443-13



WILDER  
46-445-13 Fig. 1



46-447-13  
Fig. 2



ARLT



46-449-01



46-449-02

Cautery  
Cauter  
Cauterio



WECKER  
46-461-13



WECKER  
46-462-13



CULLER  
46-467-13



WELLS  
46-482-20



ARRUGA  
46-485-13



WADSWORTH-TODD  
46-487-14



## Cyclodialysis Spatulas, Foreign Body Instruments Espátulas para ciclodíalisis, Instrumentos para cuerpos extraños



BANGERTER



46-501-06  
6 mm



46-501-10  
10 mm



46-501-12  
12 mm



46-511-13  
to  
46-517-09



CASTROVIEJO  
46-511-13  
1.2 x 10 mm



CASTROVIEJO  
46-513-14  
1.5 x 15 mm



ELSCHNIG  
46-515-14  
1.2 x 12 mm



CASTROVIEJO  
46-517-09  
0.8 x 15 mm

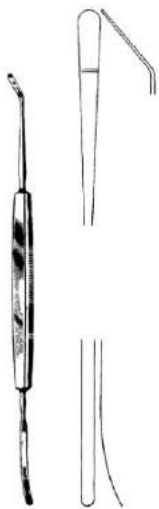

CASTROVIEJO  
46-521-12



WHEELER  
46-523-12



HIRSCHMAN  
46-524-10



CASTROVIEJO  
46-525-05 0.50 mm  
46-525-07 0.75 mm  
46-525-10 1.00 mm



BECHERT  
46-526-12



Foreign Body Instruments, Markers, Caliper  
Instrumental para cuerpos extraños, Compás y Aspiradores de la cápsula



DIX  
46-542-12



DIX  
46-544-12



DIX  
46-546-13



DIX  
46-548-13

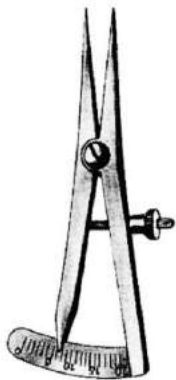

CASTROVIEJO  
46-583-07 0-20 mm  
7 cm, 2 3/4"



CONNIN-AMSLER  
46-589-13



DASTOOR  
46-590-06 6 mm



HOLTH  
46-593-09



Lacrimal Dilators, Probes  
Dilatadores, Estiletos para canal lacrimal



WILDER  
46-602-01



WILDER  
46-602-02



WILDER  
46-602-03



Fig. ZIEGLER  
1/2 46-605-12  
3/4 46-605-34  
5/6 46-605-56



CASTROVIEJO  
46-608-12

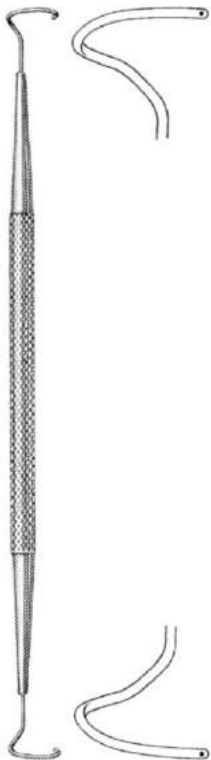

VORST  
46-609-14  
14.9 cm 5 7/8"

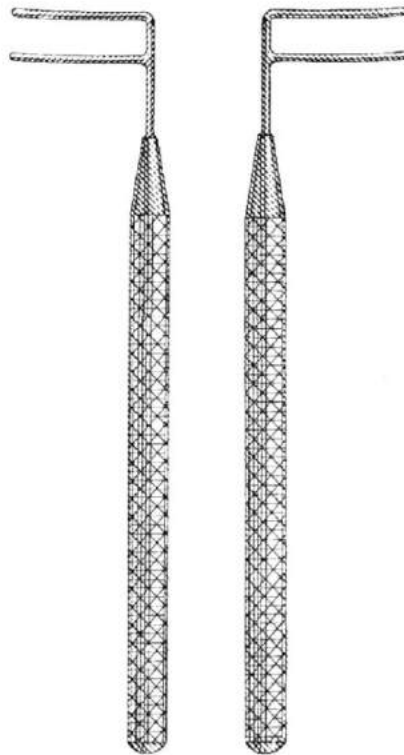

HARMS  
46-610-01 46-610-02  
4.8 cm 1 7/8"



Stainless Steel  
acero inoxidable  
acciaio inossidabile

Fig.	BOWMAN	Ø mm
0000/000	46-613-00	0.6/0.7
00/0	46-614-00	0.7/0.8
0/1	46-614-01	0.8/0.9
1/2	46-614-12	0.9/1.1
2/3	46-614-23	1.1/1.3
3/4	46-614-34	1.3/1.4
4/5	46-614-45	1.4/1.5
5/6	46-614-56	1.5/1.6
6/7	46-614-67	1.6/1.8
7/8	46-614-78	1.8/1.9

Iris Forceps  
Pinzas para iris



GRAEFE  
46-802-07  
7 cm, 2 3/4" / 1 mm



GRAEFE  
46-803-07  
7 cm, 2 3/4" / 1 mm



GRAEFE  
46-804-07  
7 cm, 2 3/4" / 1 mm

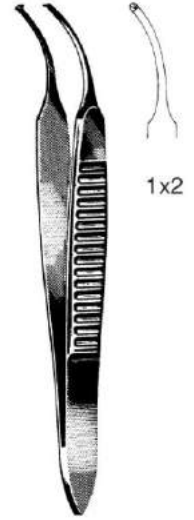

GRAEFE  
46-805-07  
7 cm, 2 3/4" / 1 mm



EYE DRESSING  
46-810-10  
10 cm  
4"



EYE DRESSING  
46-811-10  
10 cm  
4"

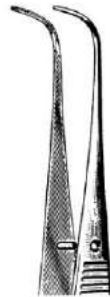

EYE DRESSING  
46-813-10  
10 cm  
4"



IRIS TISSUE FORCEPS  
46-820-10  
10 cm  
4"



IRIS TISSUE FORCEPS  
46-821-10  
10 cm  
4"



IRIS TISSUE FORCEPS  
46-823-10  
10 cm  
4"



Iris Forceps  
Pinzas para iris

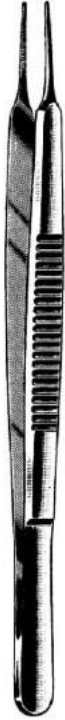

STEVENS  
46-830-10  
10.5 cm, 4.25"



STEVENS  
46-831-10  
10.5 cm  
4.25"



STEVENS  
46-833-10  
10.5 cm  
4.25"



STEVENS  
46-840-10  
10.5 cm  
4.25"



STEVENS  
46-841-10  
10.5 cm  
4.25"



STEVENS  
46-843-10  
10.5 cm  
4.25"

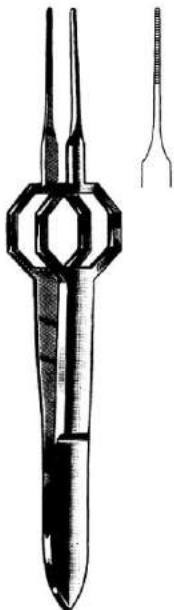

FOERSTER  
46-850-08  
8.5 cm, 3.5"



FOERSTER  
46-851-08  
8.5 cm, 3.5"



FOERSTER  
46-852-08  
8.5 cm, 3.5"

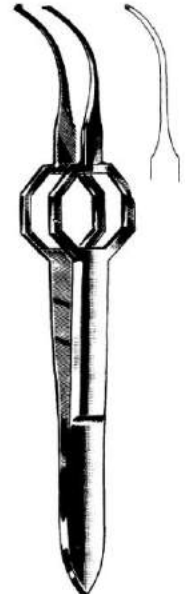

FOERSTER  
46-853-08  
8.5 cm, 3.5"

Iris Forceps  
Pinzas para iris

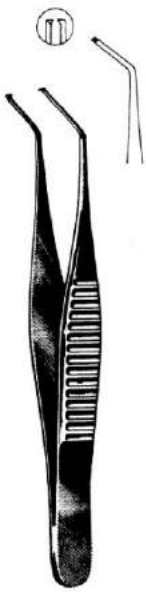

HESS  
46-855-07  
7 cm, 2 3/4"  
0.3 mm

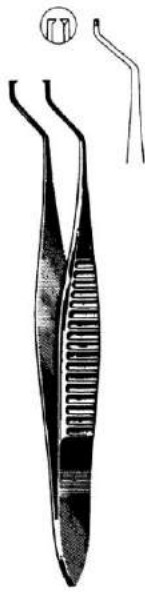

HESS  
46-857-07  
7 cm, 2 3/4"  
0.3 mm



GILL  
46-861-07  
7.5 cm, 3"  
0.3 mm

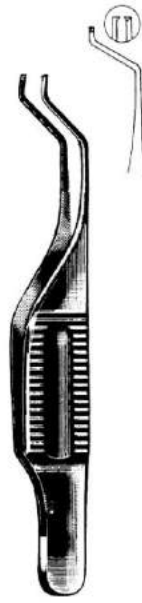

GILL-HESS  
46-863-07  
7.5 cm, 3"  
0.3 mm



GILL-HESS  
46-865-07  
7.5 cm, 3"  
0.3 mm

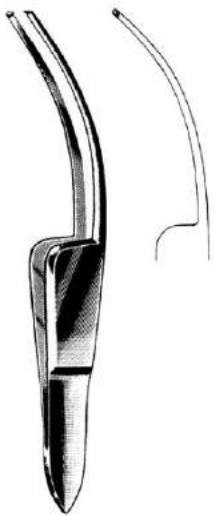

FISCHER  
46-869-07  
7 cm, 2 3/4"



BARRAQUER-KATZIN  
46-881-07  
7 cm, 2 3/4" 0.4 mm



TROUTMAN (Colibri)  
46-883-07  
7 cm, 2 3/4" 0.12 mm

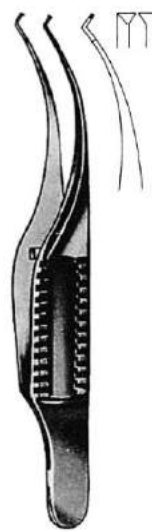

BARRAQUER (Colibri)  
46-885-07  
7 cm, 2 3/4" 0.12 mm

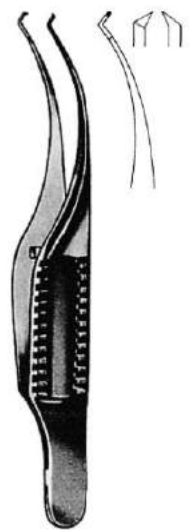

BARRAQUER (Colibri)  
46-887-07  
7 cm, 2 3/4" 0.12 mm





Strabismus Forceps, Muscle Forceps  
Pinzas para estrabismo, musculares

1x2



**KIRBY-ARTHUR**  
46-891-09 9 cm, 3 1/2"  
0.2 mm



**McCULLOUGH**  
46-902-09  
9.5 cm, 3 3/4"



**McCULLOUGH**  
46-903-09  
9.5 cm, 3 3/4"

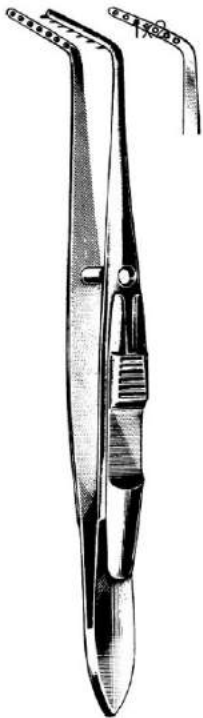

**JAMESON**  
46-907-10  
10 cm, 4"

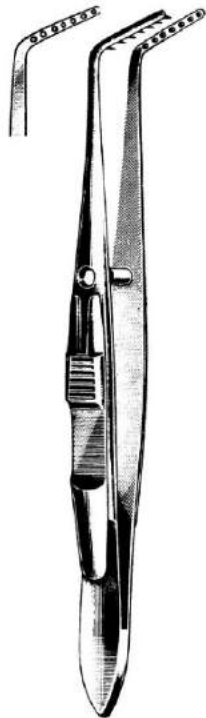

**JAMESON**  
46-909-10  
10 cm, 4"



1.7mm

**BONACCOLTO**  
46-914-10  
10 cm, 4"



Fine  
1.2mm

**BONACCOLTO**  
46-916-10  
10 cm, 4"



**BONACCOLTO**  
46-920-11  
11 cm, 4 3/8"

Iris Forceps  
Pinzas para iris



DASTOOR  
46-924-11  
11 cm, 4 <sup>3</sup>/<sub>8</sub>"

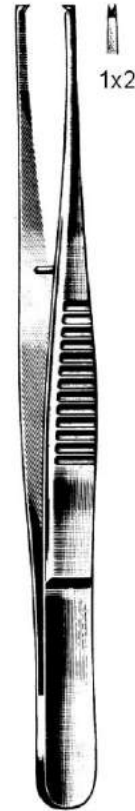

DASTOOR  
46-926-11  
11 cm, 4 <sup>3</sup>/<sub>8</sub>"



BISHOP-HARMON  
46-940-05 8.5 cm, 3.4"  
0.5 mm



BISHOP-HARMON  
46-940-08 8.5 cm, 3.4"  
0.8 mm



BISHOP-HARMON  
46-942-05 8.5 cm, 3.4"  
0.5 mm



BISHOP-HARMON  
46-942-08 8.5 cm, 3.4"  
0.8 mm



## Iris and Muscle Forceps Pinzas para iris, Pinzas musculares

With Guide Pin  
con perno guida  
con perno di guida

Without Guide Pin  
sen perno guida  
senza perno di guida



MOD. BONN  
46-944-07  
7 cm, 2 3/4"  
0.12 mm



MOD. BONN  
46-946-07  
7 cm, 2 3/4"  
0.12 mm

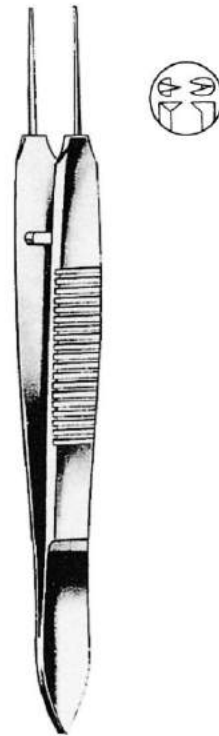

MOD. BONN  
46-948-10  
10 cm, 4"  
0.12 mm

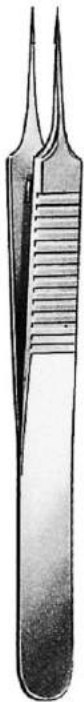

MOD. TÜBINGEN  
46-950-10  
10 cm, 4"

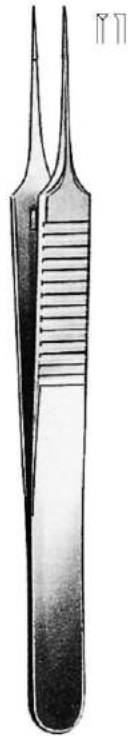

MOD. BONN  
46-952-10  
10 cm, 4", 0.12 mm



MOD. TÜBINGEN  
46-953-10  
10 cm, 4"

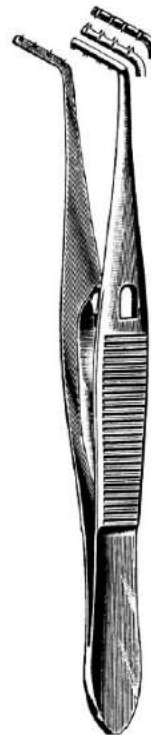

PRINCE  
46-955-10  
10 cm, 4"



PRINCE  
46-956-10  
10 cm, 4"





Muscle Forceps, Fixation Forceps  
Finzas musculares, Pinzas para fijación

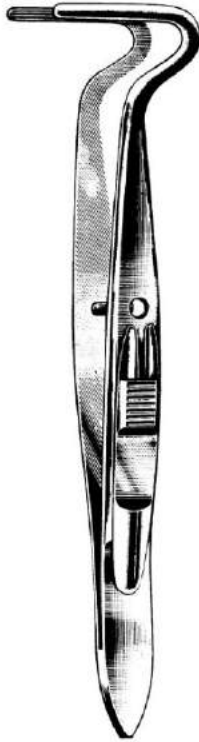

BERKE  
48-015-20 48-015-27

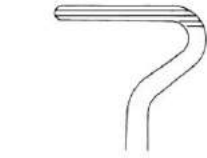

48-015-20

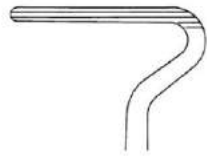

48-015-27



1x2  
TROUTMAN  
48-017-08 8.5 cm, 3.4"  
0.8 mm



ELSCHMIG  
48-046-11  
11 cm, 4 3/8"



GRAEFE  
48-050-11 48-052-11



48-050-11



48-052-11  
With Lock  
con cierre



LESTER  
48-054-09  
9 cm, 3 1/2"

## Suture, Tissue and Capsular Forceps Pinzas para sutura, Pinzas de fijación



CASTROVIEJO  
48-066-09

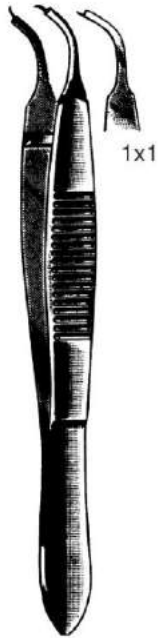

CASTROVIEJO  
48-067-09



CASTROVIEJO  
48-068-09

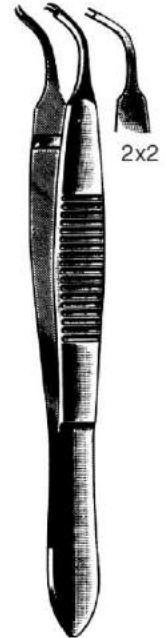

CASTROVIEJO  
48-069-09



BARRAQUER  
48-074-10  
10 cm, 4"

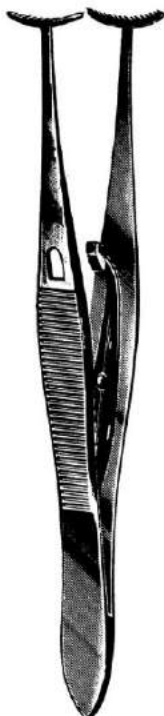

GREEN  
48-076-05 to 48-078-10  
10 cm, 4"



48-076-05 5 mm      48-076-10 10 mm

Without Lock  
sin cierre  
senza cremagliera



48-078-05 5 mm      48-078-10 10 mm

With Lock  
con cierre  
con cremagliera



GILL-ARRUGA  
48-101-07  
7.5 cm, 3"



Capsular Forceps  
Pinzas capsulares



TERSON  
48-103-09  
9 cm, 3 1/2"



KALT  
48-106-10  
10 cm, 4"

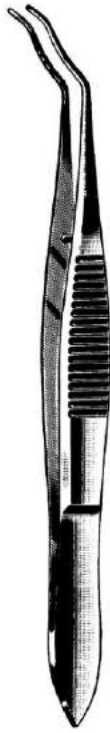

ELSCHNIG  
48-109-10  
10 cm, 4"



ARRUGA  
48-111-10  
10 cm, 4"

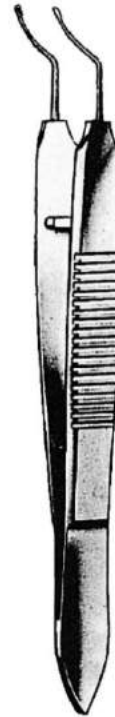

ARRUGA  
48-114-10  
10 cm, 4"



CASTROVIEJO  
48-115-10  
10 cm, 4"



SCHWEIGGER  
48-117-10  
10 cm, 4"



SCHWEIGGER  
48-119-10  
10 cm, 4"



ELSCHNIG  
48-121-10  
10 cm, 4"



HESS  
48-125-06  
6 cm, 2.4"

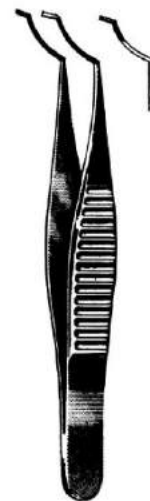

HESS  
48-127-06  
6.5 cm, 2.6"



FUCHS  
48-129-07  
7 cm, 2 3/4"



## Suturing, Ligature Forceps, Tying Forceps Pinzas para suturas y para ligaduras



<b>CASTROVIEJO</b>	Teeth diente dente	<b>CASTROVIEJO</b>
48-150-01	0.12 mm	
48-150-03	0.30 mm	
48-150-05	0.50 mm	48-151-05
48-150-10	1.00 mm	48-151-10
48-150-15	1.50 mm	48-151-15

**MOORFIELD**  
48-164-10  
10 cm, 4"

**St. MARTIN**  
48-166-07  
7 cm, 2 3/4"

**TÜBINGEN**  
48-181-10  
10 cm, 4"



1x2

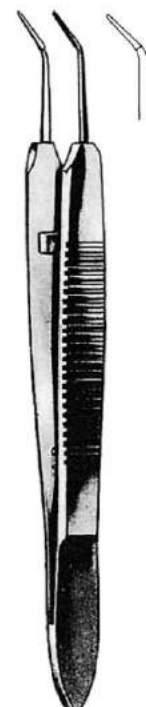
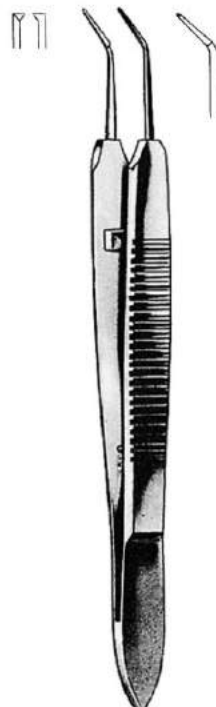

**PAUFIQUE**  
48-190-08  
8.5 cm, 3.4"

**PAUFIQUE**  
48-202-08  
8.5 cm, 3.4"

**McPHERSON**  
48-210-10  
10 cm, 4"

**McPHERSON**  
48-220-10  
10 cm, 4"





Chalazion, Entropium, Trachoma Forceps  
Pinzas de chalazión, de entropión y para tracoma



AYER  
48-240-09  
9 cm, 3 1/2"



AYER  
48-242-09  
9 cm, 3 1/2"



LAMBERT  
48-246-09  
9 cm, 3 1/2"



DESMARRES  
48-254-09 to 48-258-09  
9 cm, 3 1/2"



48-254-09  
Small

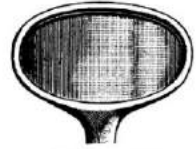

48-256-09  
Medium

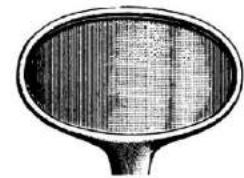

48-258-09  
Large

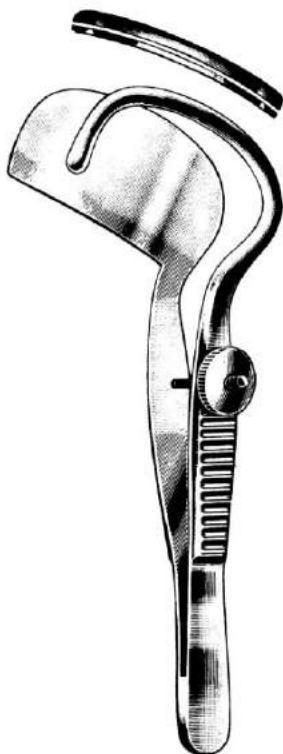

SNELLEN  
48-265-10 10 cm, 4"

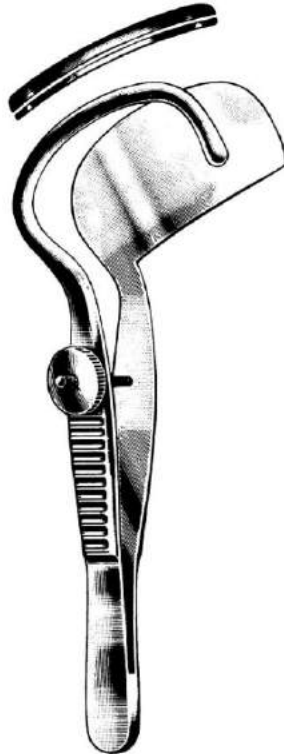

SNELLEN  
48-267-10 10 cm, 4"

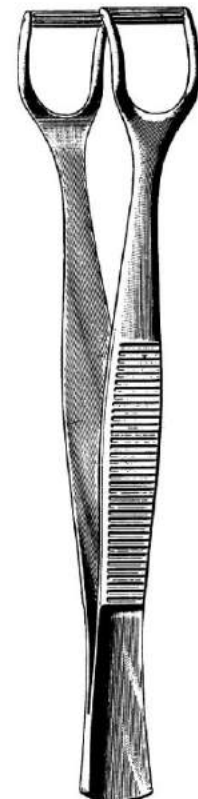

KNAPP-LUER  
48-274-11 11 cm, 4 3/8"



Irrigation and Aspiration Cannulas, Eye Cannulas, Tonometer  
 Cánulas de irrigación y aspiración, Cánulas oculares, Tonómetro



SIMCOE  
 48-300-23  
 23 gauge

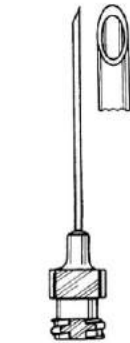

SCHEIE  
 48-302-28  
 1.8 x 28 mm



SCHEIE  
 48-302-33  
 1.5 x 33 mm



MOD. TÜBINGEN  
 48-303-45



MOD. HAMBURG  
 48-305-00



SIMCOE  
 48-306-00



MOD. BONN  
 48-307-00



MOD. BONN  
 48-309-00



SCHIOTZ  
 48-404-00 Straight recta  
 48-406-00 Angled oblicua



Eye Magnet, Cilia Forceps  
Imàn para cuerpos extraños, Pinzas depilatorias



**Cilia and Suture Forceps**  
9cm, 3.5"

- 48-410-09 Portal Type
- 48-411-09 Planet Type
- 48-415-09 Swiss Type



**Eye Magnet/Loop**  
48-408-00

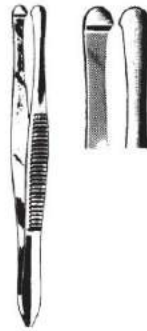

**BEER**  
48-420-09  
9 cm, 3 1/2"



**DOUGLAS**  
48-422-09  
9 cm, 3 1/2"

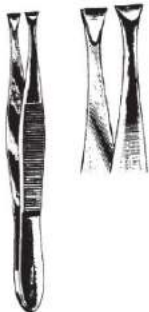

**LITTAUER**  
48-424-08  
8.5 cm, 3.4"



**BARRAQUER**  
48-425-10  
10.5 cm, 4.1"



**BERGH**  
48-426-09  
9 cm, 3 1/2"

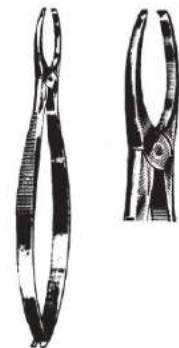

**GRADLE**  
48-428-09  
9.5 cm, 3 3/4"



## Micro Intraocular Forceps with Elbow Jaws Micro pinzas intraoculares

New Models with fiberglass light carrier  
Nuevos modelos con conductor p. luz fibra-óptica  
Nuovi modelli con guida per luce a fibre ottiche

Cold Light Projector, 90 watt, 220 volt, with 1 light outlet,  
stepless light adjustment and fibreglass light cable, 230 cm,  
with Luer-Lock attachment are available an request.

W/Luer-Lock Adapter for fiberglass light cable  
c/adaptador Luer Lock p. cable de fibra-optica  
c/raccordo Luer-Lock per cavi a fibre ottiche

	Smooth jaws lisa liscia	Serrated jaws estriada zigrinata	Cups jaws cucharilla morso a cucchiaio		Smooth jaws lisa liscia	Serrated jaws estriada zigrinata	Cups jaws cucharilla morso a cucchiaio
<p>15.5 cm, 6" 0.9 mm Ø</p>	 48-640-00	 48-650-00 Sraight, recta, retta	 48-660-00	<p>16.5 cm, 6 1/2" 0.9 mm Ø</p>	 48-670-00	 48-680-00 Straight, recta, retta	 48-690-00
	 48-643-30	 48-653-30 30° Angled up, angulada, angolata	 48-663-30		 48-673-30	 48-683-30 30° Angled up, angulada, angolata	 48-693-30
	 48-646-60	 48-656-60 60° Angled up, angulada, angolata	 48-666-60		 48-676-60	 48-686-60 60° Angled up, angulada, angolata	 48-696-60
	 48-649-90	 48-659-90 90° Angled up, angulada, angolata	 48-669-90		 48-679-90	 48-689-90 90° Angled up, angulada, angolata	 48-699-90
		 48-672-12 1x2 Teeth, Straight recta, 1x2 dientes 1x2 dentini, retta				 48-642-12 1x1 Teeth, Straight recta, 1x1 dientes 1x1 dentini, retta	



## Micro Intraocular Forceps with Guillotine Jaws Micro pinzas intraoculares

W/Luer-Lock Adapter for fiberglass light cable  
c/adaptador Luer Lock p. cable de fibra-optica  
c/raccordo Luer-Lock per cavi a fibre ottiche

New Models with fiberglass light carrier  
Nuevos modelos con conductor p. luz fibra-óptica  
Nuovi modelli con guida per luce a fibre ottiche

Smooth jaws  
lisa  
liscia

Serrated jaws  
estriada  
zigrinata

Cups jaws  
cucharilla  
con incavo

Smooth jaws  
lisa  
liscia

Serrated jaws  
estriada  
zigrinata

Cups jaws  
cucharilla  
con incavo



48-746-60

48-756-60  
60° Angled,  
angulada, angolata

48-766-60



48-776-60

48-786-60  
60° Angled,  
angulada, angolata

48-796-60



48-749-90

48-759-90  
90° Angled,  
angulada, angolata

48-769-90



48-779-90

48-789-90  
90° Angled,  
angulada, angolata

48-799-90



15.5 cm, 6"  
0.9 mm Ø



16.5 cm, 6 1/2"  
1.3 mm Ø





## Ear Specula Especulos auriculares

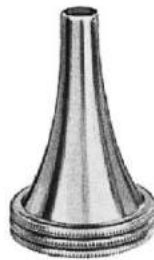

**POLITZER**  
50-009-00  
Set of 3

∅  
○ 2 mm  
50-009-02

○ 3 mm  
50-009-03

○ 4 mm  
50-009-04



**HARTMAN**  
50-010-00  
Set 4 to 7 mm

∅  
○ 2mm  
50-010-20

○ 3mm  
50-010-30

○ 4.5mm  
50-010-45

○ 5.5mm  
50-010-55

○ 6.5mm  
50-010-65

○ 7.5mm  
50-010-75



**HARTMAN**  
50-011-00  
Set 3-7 mm

Anodized  
negro  
nero

∅  
○ 3 mm  
50-011-03

○ 4 mm  
50-011-04

○ 5 mm  
50-011-05

○ 7 mm  
50-011-07

○ 8 mm  
50-011-08



**TOYNBEE**  
50-012-00  
Set 4-6 mm

① ∅  
4 mm  
50-012-40

② 5.5 mm  
50-012-55

③ 6.5 mm  
50-012-65

④ 7.5 mm  
50-012-75



**GRUBER**  
50-014-00  
Set of 4

① ∅  
4.5 mm  
50-014-45

② 5.5 mm  
50-014-55

③ 6.5 mm  
50-014-65

④ 7.5 mm  
50-014-75



**GRUBER**  
50-015-00  
Set of 4

① ∅  
4.5 mm  
50-015-45

② 5.5 mm  
50-015-55

③ 6.5 mm  
50-015-65

④ 7.5 mm  
50-015-75



**BOUCHERON**  
50-018-00  
Set of 4

③ 50-018-50  
5 mm

④ 50-018-60  
6 mm

⑤ 50-018-70  
7 mm

⑥ 50-018-80  
8 mm



## Ear Specula Espéculos auriculares

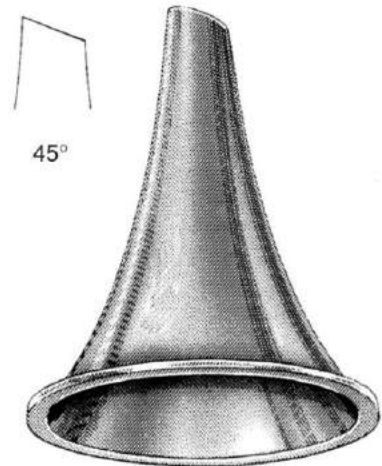
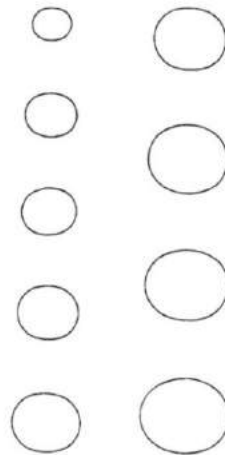
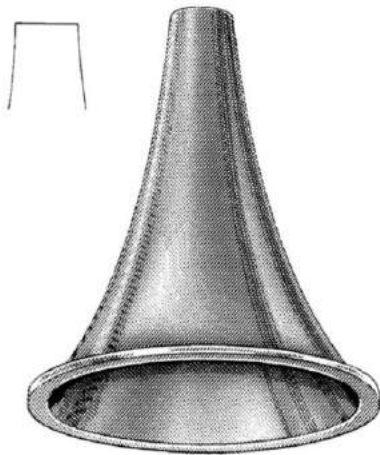

FARRIOR

50-019-30	3.0 x 4.0 mm
50-019-40	4.0 x 5.0 mm
50-019-45	4.5 x 5.5 mm
50-019-50	5.0 x 6.0 mm
50-019-55	5.5 x 6.5 mm
50-019-60	6.0 x 7.0 mm
50-019-65	6.5 x 7.5 mm
50-019-70	7.0 x 8.0 mm
50-019-75	7.5 x 8.5 mm

FARRIOR

50-020-30	3.0 x 4.0 mm
50-020-40	4.0 x 5.0 mm
50-020-45	4.5 x 5.5 mm
50-020-50	5.0 x 6.0 mm
50-020-55	5.5 x 6.5 mm
50-020-60	6.0 x 7.0 mm
50-020-65	6.5 x 7.5 mm
50-020-70	7.0 x 8.0 mm
50-020-75	7.5 x 8.5 mm

50-020-01  
Ø 3 mm

50-020-02  
Ø 4 mm

50-020-03  
Ø 5 mm

50-020-04  
Ø 6 mm

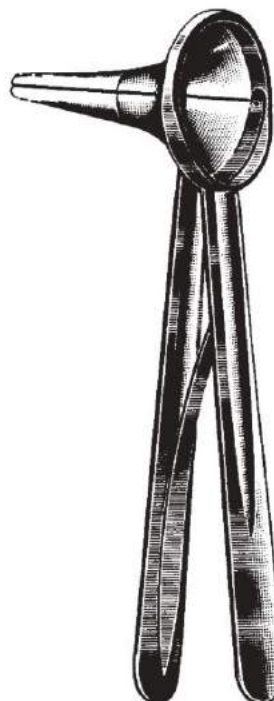

RICHNAU-HOLMGREN



Ear Specula  
Espéculos auriculares

6.5 mm

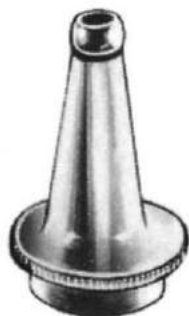

50-030-06

7.5 mm



50-030-07

8.2 mm



50-030-08

10 mm



50-030-10

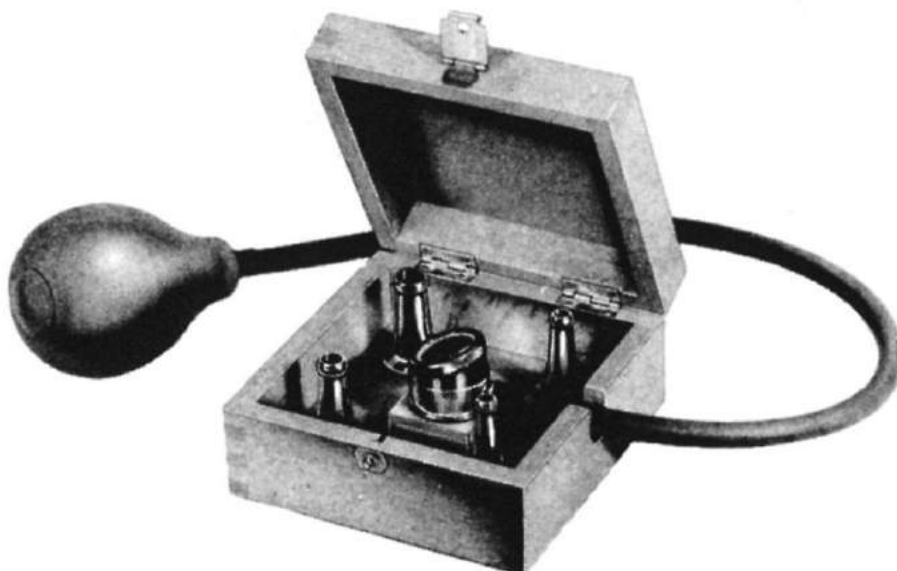

BRUENINGS  
50-030-04  
Complete

Complete consisting of:  
4 specula, suction head and rubber tube with bulb, wooden case

Compuesto de:  
4 espéculos, cámara de aspiración, insuflador de goma, en estuche de madera

Composta da:  
4 specoli, camera aspirante con soffiatrice, scatola di legno

50-036-09  
Magnification Glass  
lupa / lente d'ingrandimento

50-036-10  
Rubber Ball  
pera de goma / soffiatrice di gomma

Ear Specula  
Espéculos auriculares



6.5 mm Ø



50-036-06



7 mm Ø



50-036-07



8 mm Ø



50-036-08



SIEGLE  
50-036-03  
Complete

Complete consisting of:  
3 Ear Specula, 1 Rubber Tube with Bulb

Compuesto de:  
Otoscopio con 3 espéculos, insuflador y tubo

Composta da:  
Otoscopio con 3 specoli e 1 insufflatore con tubo

Tuning Forks  
Diapasones

BOOTNAS Aluminum

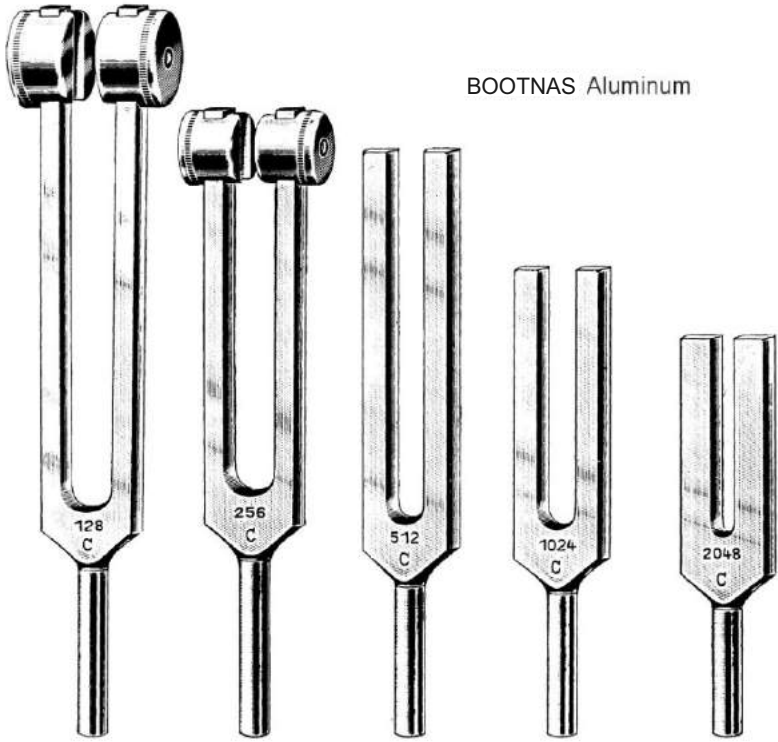

50-060-01 C 128    50-060-02 C 256    50-060-03 C 512    50-060-04 C 1024    50-060-05 C 2048

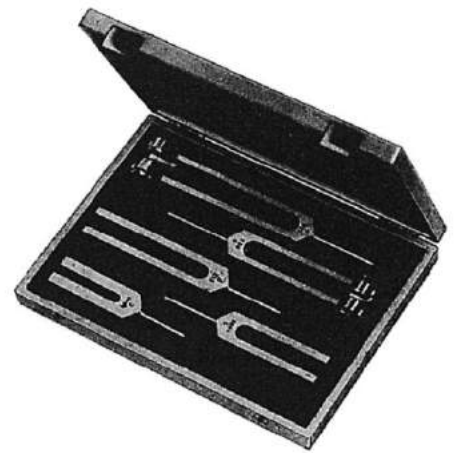

50-061-00 Complete Set

STAINLESS

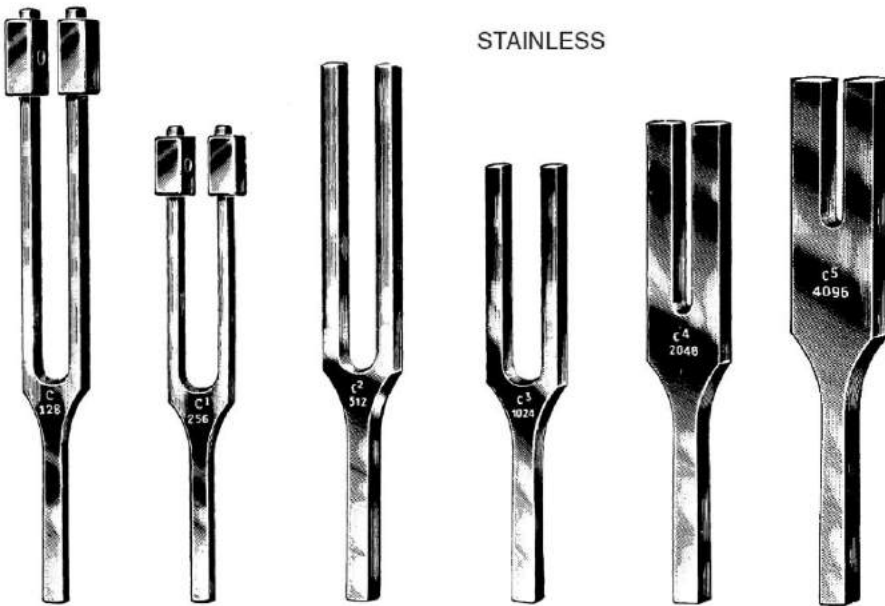

50-070-01 C 128    50-070-02 C 256    50-070-03 C 512    50-070-04 C 1024    50-070-05 C 2048    50-070-06 C 4096



HARTMAN  
50-071-00 Complete



## Tuning Forks Diapasones para neurología, Ensordecedor



LUCAE  
50-073-01 C 128  
50-073-02 C 256  
50-073-03 C 512  
50-073-04 C 1024  
50-073-05 C 2048  
50-073-06 C 4096



LUCAE  
50-074-01  
C 128

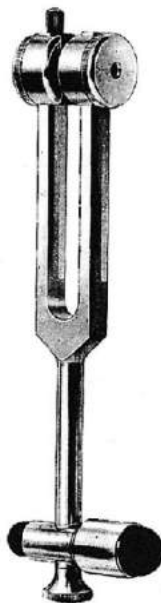

Combo  
50-075-00  
C 128



RYDEL-SEIFFERT  
50-076-01 C 64



## Noise Apparatus, Powder Blowers Ensofdecodor, Lanzapolvo

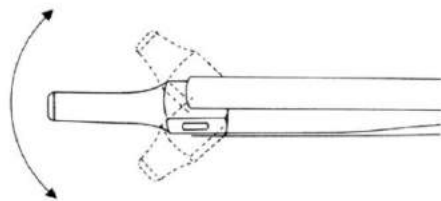
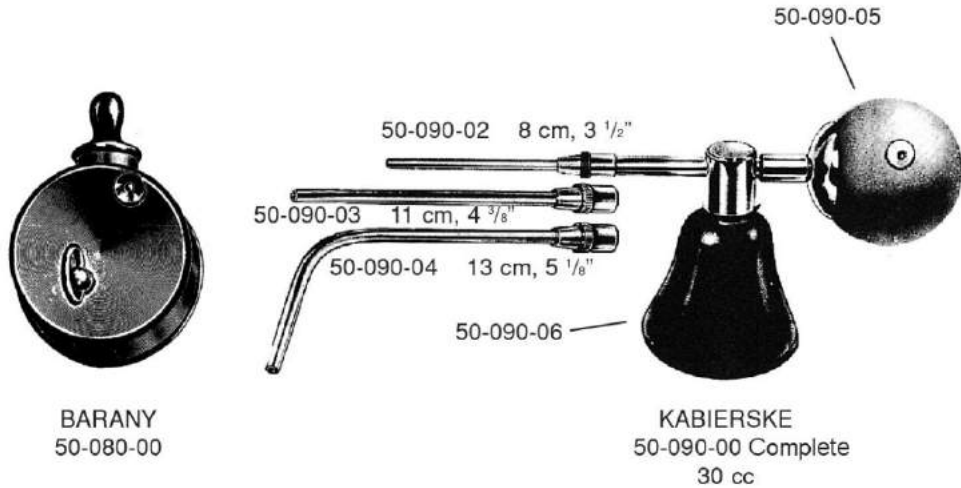

Universal  
50-090-08

Complete with Movable Tube, Screw Bottle  
30 ccm and Rubber Bulb  
completo con tubo móvil botella con rosca  
30 ccm y pera de goma  
completo con tubo mobile, bottiglia con  
filettatura 30 ccm e pera di insufflazione



Air Bag, Ear Syringe  
 Insuflador de aire, Jeringa



**POLITZER**  
 50-091-00 Set  
 With  
 50-091-03  
 50-091-15  
 50-091-17  
 50-091-22



50-091-03



50-091-04  
 4 mm Ø



50-091-15  
 15 mm Ø



50-091-17  
 17 mm Ø



50-091-22  
 22 mm Ø

**POLITZER**  
 50-091-01 Set  
 With  
 50-091-03  
 50-091-04  
 50-091-15  
 50-091-17  
 50-091-22

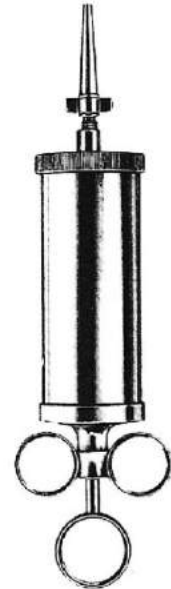

ml	oz	REINER
		Complete
50	1.5	50-096-50
75	2	50-096-75
100	3	50-097-10
150	4	50-097-15

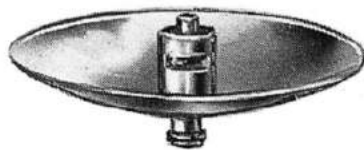

50-097-01



50-097-02



50-097-03



Curettes  
Curetas  
Curette



Fig. 00



0



1



2



3



4



5

Blunt  
romas  
smusse



50-109-00

50-110-00

50-110-01

50-110-02

50-110-03

50-110-04

50-110-05

Sharp  
cortantes  
taglienti



50-111-00

50-112-00

50-112-01

50-112-02

50-112-03

50-112-04

50-112-05

Blunt  
romas  
smusse



50-114-00

50-115-00

50-115-01

50-115-02

50-115-03

50-115-04

50-115-05

Sharp  
cortantes  
taglienti



50-116-00

50-117-00

50-117-01

50-117-02

50-117-03

50-117-04

50-117-05

BUCK



Catheters, Paracentesis Needles, Ear Knives  
 Cateteres, agujas para paracentesis, Cuchillos auriculares

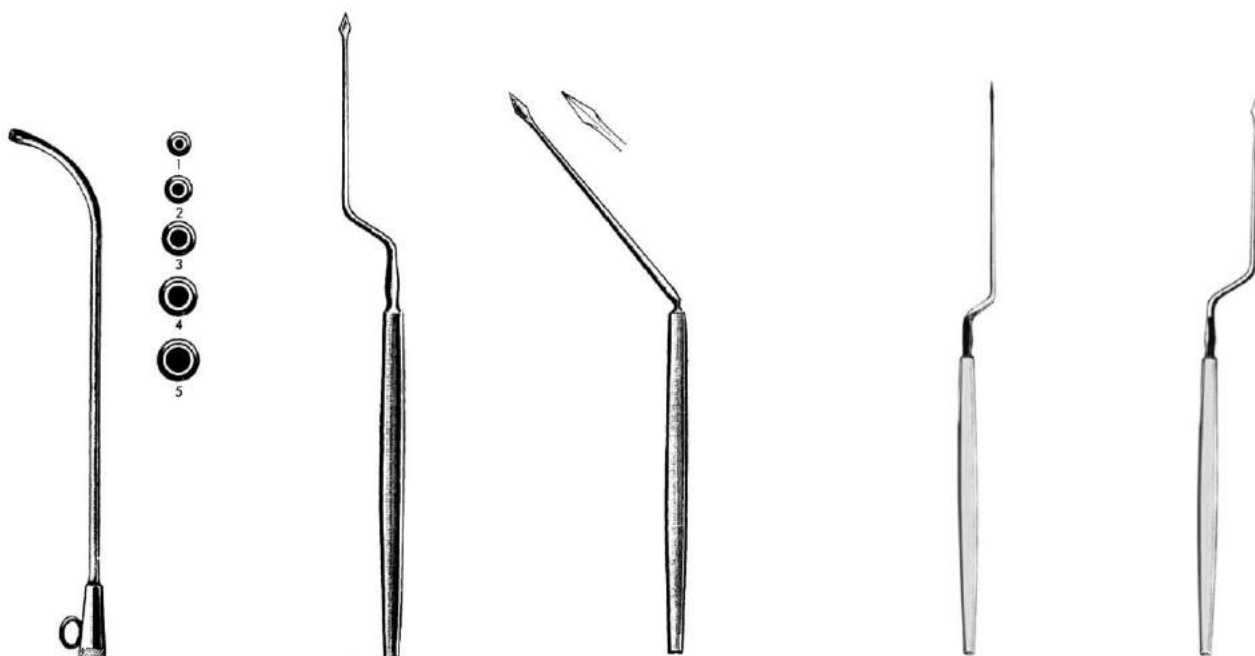

Fig. HARTMAN  
 1 50-133-01 3.5 mm  
 2 50-133-02 4.0 mm  
 3 50-133-03 4.5 mm  
 4 50-133-04 5.0 mm  
 5 50-133-05 6.0 mm

POLITZER  
 50-150-18  
 18 cm, 7"

POLITZER  
 50-151-16  
 16.5 cm, 6 1/2"

LUCAE  
 50-152-01  
 18 cm, 7"

LUCAE  
 50-152-02  
 18 cm, 7"

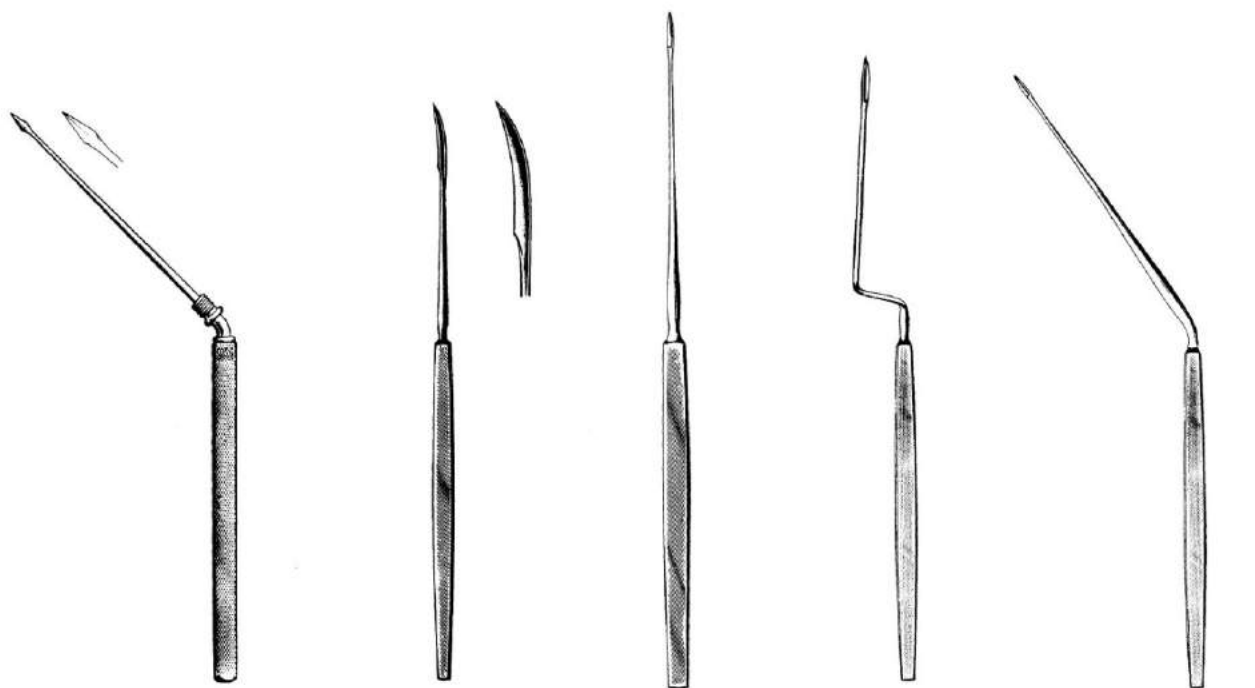

POLITZER  
 50-153-16

POLITZER  
 50-160-15  
 15 cm, 6"

SEXTON  
 50-162-18  
 18 cm, 7"

SEXTON  
 50-164-17  
 17 cm, 6 3/4"

SEXTON  
 50-165-17  
 17 cm, 6 3/4"





## Ear Spoons, Loops and Hooks Cucharas, Asas, Ganchitos



**GROSS**  
50-171-12  
12 cm, 4 3/4"



**BILLEAU**  
50-180-01 to 50-180-03  
16 cm, 6 1/4"



50-180-01



50-180-02



50-180-03



**LANGENBECK**  
50-181-13  
13 cm, 5 1/8"



**ZAUFAL**  
50-184-16  
16 cm, 6 1/4"



**ZAUFAL-JANSEN**  
50-185-15  
15 cm, 6"



**DAY**  
50-190-01 50-190-02  
16 cm, 6 1/4"



50-190-01



50-190-02



**WAGENER**  
50-192-01 to 50-192-04  
14 cm, 5 1/2"



50-192-01



50-192-03



50-192-02



50-192-04



**LUCAE**  
14 cm, 5 1/2"



50-193-01  
2 mm



50-193-02  
3 mm



50-193-03  
4 mm



## Ear Curettes, Dressing Forceps Cucharas, Asas, Ganchitos, Pinzas

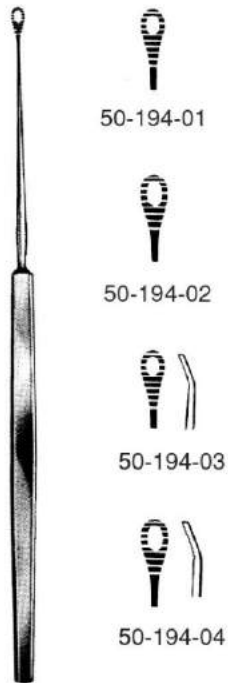

**SHAPLEIGH**  
50-194-01 to 50-194-04  
13 cm, 5 1/8"

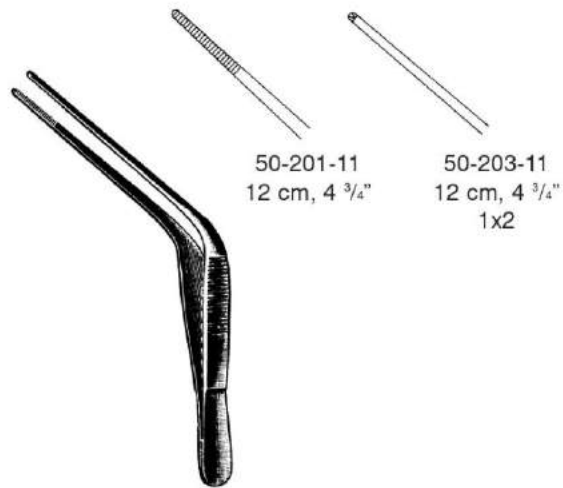

**WILDE**



**LUCAE**  
50-206-14  
14 cm, 5 1/2"



**LUCAE**  
50-206-16  
16 cm, 6 1/4"



**COTTLE**  
50-208-14  
14 cm, 5 1/2"



Ear Snares, Forceps  
Cierra-nudos, Pinzas auriculares



**KRAUSE**  
50-220-16  
16 cm, 6 1/4"

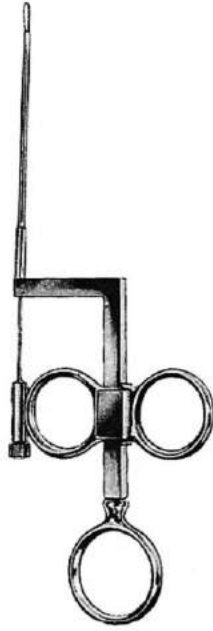

**WILDE**  
50-222-17  
17 cm, 6 3/4"



50-225-02  
Pkg of 12  
0.2 mm

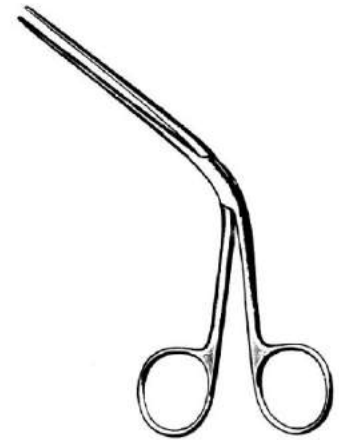

**TILLEY**  
50-243-14  
14 cm, 5 1/2"



**LITTAUER**  
50-245-12  
12 cm, 4 3/4"

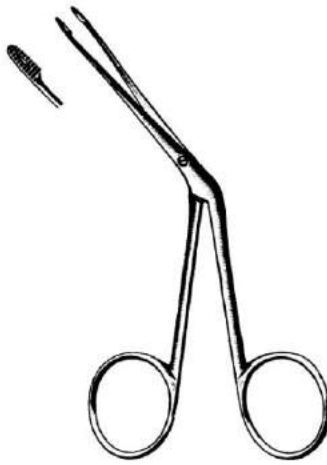

**HARTMAN**  
50-246-12  
12 cm, 4 3/4"

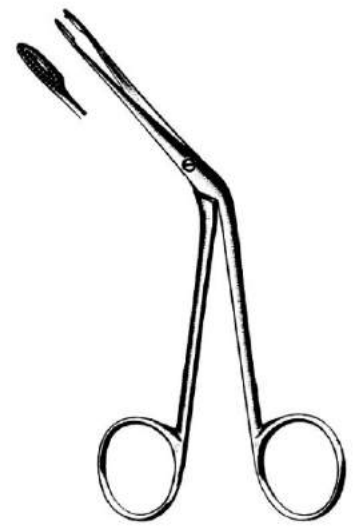

**HARTMAN**  
50-246-14  
14 cm, 5 1/2"



## Foreign Body Levers, Ear Alligator Forceps Elevadores para cuerpos extraños, Pinzas para pólipos



**QUIRE**  
50-251-10  
10 cm, 4"



**BUCK**  
50-253-11  
11 cm, 4 3/8"

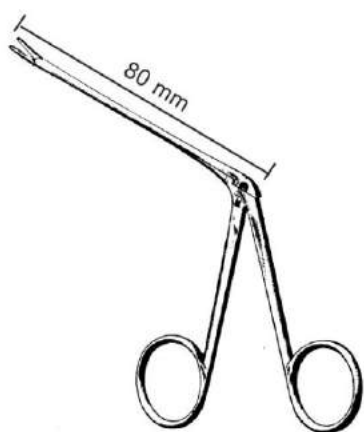

50-255-08 to 50-275-08



**HARTMAN-WULLSTEIN**  
50-255-08  
8.5 cm, 3.4"



**HARTMAN-WULLSTEIN**  
1 mm 50-257-08  
8.5 cm, 3.4"



**HARTMAN**  
50-261-08 8.5 cm, 3.4"  
50-261-14 14.0 cm, 5 1/2"  
50-261-16 16.0 cm, 6 1/4"



**HARTMAN**  
50-263-08 8.5 cm, 3.4"  
50-263-14 14.0 cm, 5 1/2"



**HARTMAN**  
50-265-08  
8.5 cm, 3.4"



Ø mm **HARTMAN**  
2.0 50-267-20 8.5 cm, 3.4"  
2.5 50-267-25 8.5 cm, 3.4"  
3.0 50-267-30 8.5 cm, 3.4"

○ 3 mm Ø



**HARTMAN**  
50-269-30  
8.5 cm, 3.4"



**STRUEMPEL**  
50-271-08 8.5 cm, 3.4"  
2.5 x 5 mm



**HARTMAN**  
50-273-08  
8.5 cm, 3.4"

○ 2 mm Ø



**HARTMAN-HOFFMAN**  
50-275-08  
8.5 cm, 3.4"



Micro Ear Scissors, Micro Ear Forceps  
Tijeras auriculares micro, Pinzas auriculares micro



50-310-40 to 50-322-70



**A**  
BELLUCCI  
50-310-40  
micro mini  
4 mm



**A**  
BELLUCCI  
50-312-55  
micro standard  
5.5 mm



**D**  
BELLUCCI  
50-313-55  
micro standard  
5.5 mm

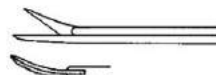

**B**  
BELLUCCI  
50-315-55  
micro standard  
5.5 mm

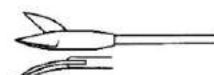

**C**  
BELLUCCI  
50-317-55  
micro standard  
5.5 mm



**A**  
SHEA  
50-320-70  
7.0 mm

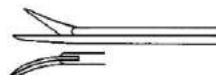

**C**  
SHEA  
50-321-70  
7.0 mm



**B**  
SHEA  
50-322-70  
7.0 mm

- A: Straight / recto / retta**
- B: Right / derecha / destra**
- C: Left / izquierda / sinistra**
- D: Curved Up / curva in alto / curva hacia arriba**
- E: Curved Down / curva in basso / curva hacia abajo**



50-350-40 to 50-360-35



**A**  
50-350-40  
4 mm

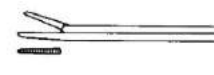

**A**  
50-350-70  
7 mm

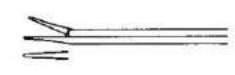

**A**  
50-352-40  
4 mm

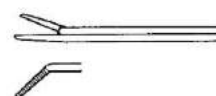

**C**  
50-353-60  
6 mm

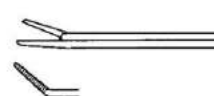

**B**  
50-355-60  
6 mm



**D**  
50-357-40  
4 mm



**E**  
50-359-40  
4 mm

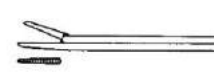

**A**  
50-360-35  
3.5 mm



## Micro Ear Forceps Pinzas auriculares micro



50-362-45 to 50-383-30



**A**  
50-362-45  
4.5 mm



**C**  
50-363-45  
4.5 mm



**B**  
50-365-45  
4.5 mm



**D**  
50-367-50  
5.0 mm



**E**  
50-369-50  
5.0 mm



**A**  
GREVEN  
50-370-50  
5.0 mm



McGEE  
50-371-40  
0.8 x 4.0 mm



COS  
50-373-30  
1.8 x 0.8 x 3.0 mm

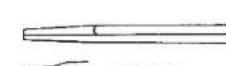

JUERS  
50-375-60  
6.0 mm

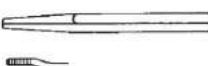

JUERS  
50-377-60  
6.0 mm



**C**  
HAUGH  
50-381-30  
45° 3 mm



**B**  
HAUGH  
50-383-30  
45° 3 mm

- A: Straight / recto / retta**
- B: Right / derecha / destra**
- C: Left / izquierda / sinistra**
- D: Curved Up / curva in alto / curva hacia arriba**
- E: Curved Down / curva in basso / curva hacia abajo**

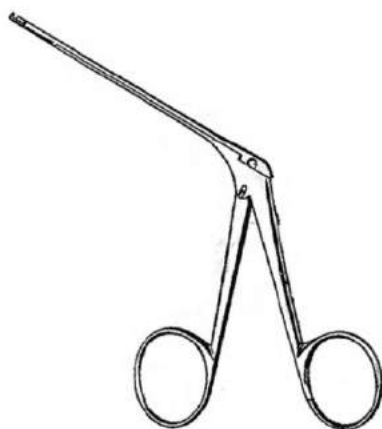

DIETER  
50-385-01 to 50-387-02

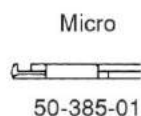

Micro  
50-385-01

Upward  
arriba  
in alto



Mini  
50-387-01

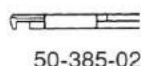

50-385-02

Downward  
abajo  
in basso



50-387-02



Micro Ear Forceps  
Pinzas auriculares micro

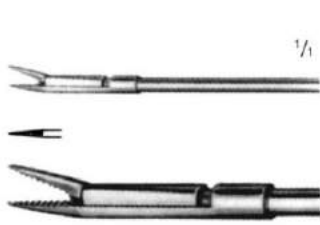

50-390-35  
0.8 x 3.5 mm

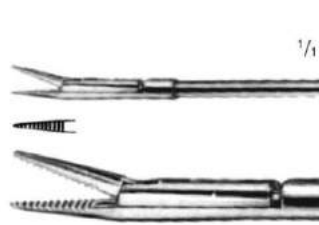

50-390-50  
1 x 5 mm

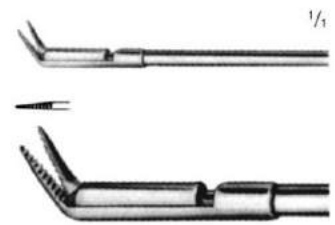

50-391-35  
0.8 x 3.5 mm

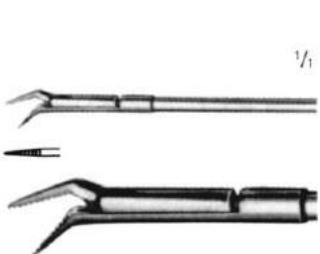

50-392-35  
0.8 x 3.5 mm

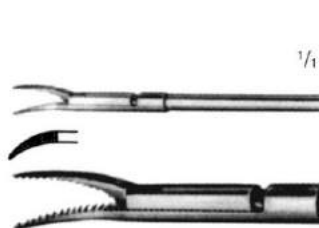

50-393-50  
1 x 5 mm

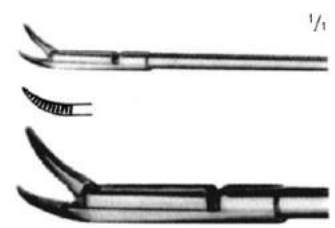

50-394-50  
1 x 5 mm



Micro Ear Forceps  
Pinzas auriculares micro



WULLSTEIN

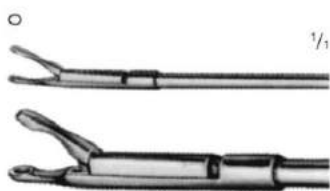

50-400-01  
0.9 x 1 mm

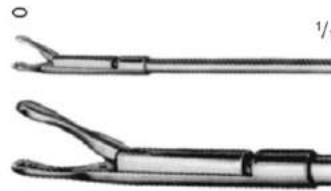

50-400-02  
0.8 x 1.3 mm

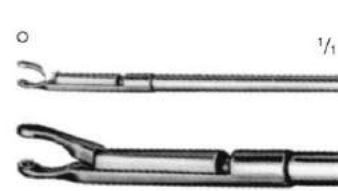

50-400-03  
1 mm

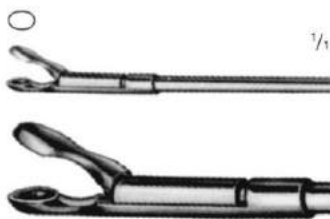

50-401-25  
1.7 x 2.5 mm

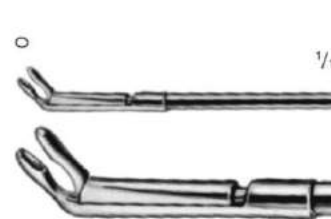

50-402-10  
0.9 x 1 mm

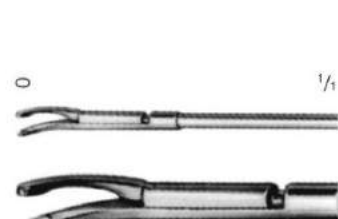

50-403-13  
0.8 x 1.3 mm



50-404-13  
0.8 x 1.3 mm





Micro Ear Scissors  
Pinzas auriculares micro



BELLUCCI



50-410-01

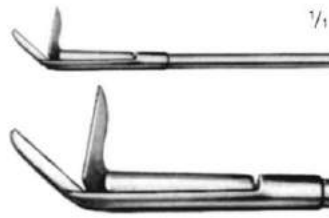

50-411-01



50-412-01



50-413-01



50-414-01



## Knives Cuchillos



SCHUKNECHT  
50-701-01



SCHUKNECHT  
50-701-02



SCHUKNECHT  
50-703-15  
15.5 cm, 6"



WULLSTEIN  
50-704-15  
15.5 cm, 6"



TABB  
50-705-15  
15.5 cm, 6"



PLESTER  
50-706-35 15.5 cm, 6"  
3.5 mm Ø



ROSEN  
50-709-10 to 50-709-30

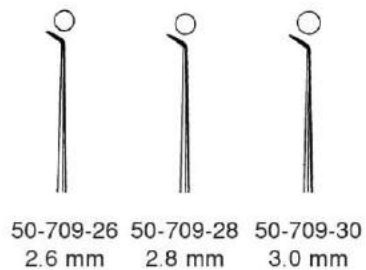
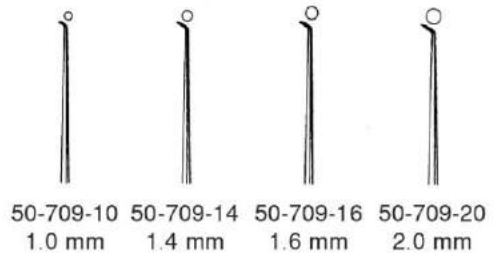



Needles and Hooks  
Agujas y Ganchos



BARBARA  
50-710-15



BARBARA  
50-711-15



BARBARA  
50-713-15



BARBARA  
50-715-17



mm	25°
0.3	BARBARA
0.6	50-720-03
1.0	50-720-06
1.2	50-720-10
1.5	
2.0	
2.5	



	45°
	BARBARA
	50-722-03
	50-722-06
	50-722-10
	50-722-12
	50-722-15
	50-722-20
	50-722-25



	90°
	BARBARA
	50-724-03
	50-724-06
	50-724-10
	50-724-12
	50-724-15
	50-724-20
	50-724-25



	BARBARA
50-725-05	0.5 mm
50-725-10	1.0 mm



mm	90°	90°
0.3	50-730-03	50-732-03
0.6	50-730-06	50-732-06
1.0	50-730-10	50-732-10



mm	McGEE	McGEE
0.5	50-733-05	50-735-05
1.0	50-733-10	50-735-10



	BARBARA
	50-736-15
	15.5 cm, 6"



ROSEN  
50-737-15  
15.5 cm, 6"



mm	25°	25°	45°	45°
0.3	50-741-03	50-743-03	50-745-03	50-747-03
0.6	50-741-06	50-743-06	50-745-06	50-747-06
1.0	50-741-10	50-743-10	50-745-10	50-747-10

50-730-03 to 50-747-10



## Dissectors, Curettes and Elevators Disectores, Curetas, Elevadores

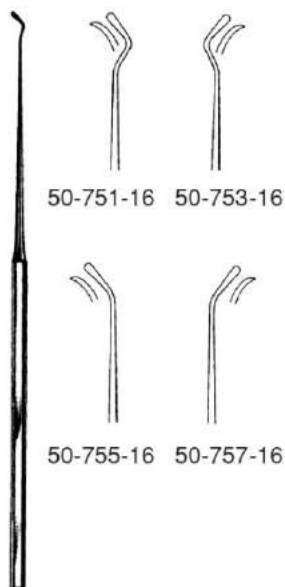

50-751-16 50-753-16

50-755-16 50-757-16

FISCH

50-751-16 to 50-757-16

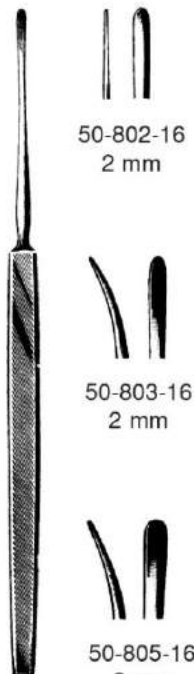

50-802-16  
2 mm

50-803-16  
2 mm

50-805-16  
3 mm

LEMPERT

50-802-16 to 50-805-16

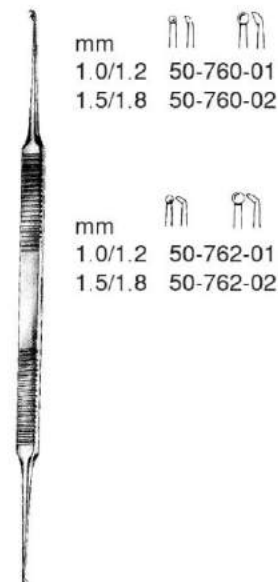

mm 50-760-01  
1.0/1.2 50-760-02  
1.5/1.8

mm 50-762-01  
1.0/1.2 50-762-02  
1.5/1.8

HOUSE

50-760-01 to 50-762-02

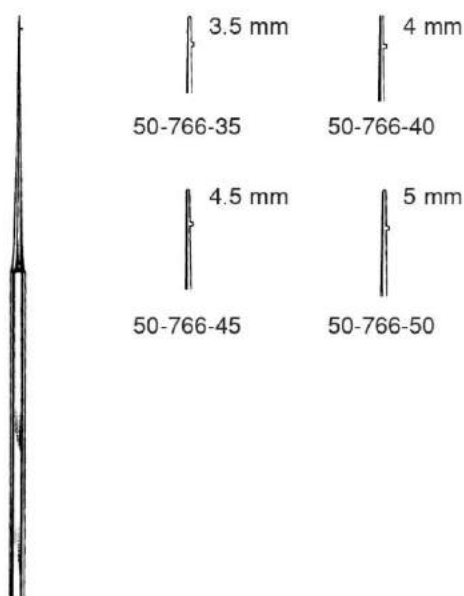

3.5 mm  
50-766-35

4 mm  
50-766-40

4.5 mm  
50-766-45

5 mm  
50-766-50

HOUSE

50-766-35 to 50-766-50



LEMPERT  
50-807-20  
20.5 cm, 8"



MUCK  
50-812-13  
13 cm, 5 1/8"



Nasal Specula  
Espéculos nasales



**THUDICHUM**  
52-050-01 to 52-050-07

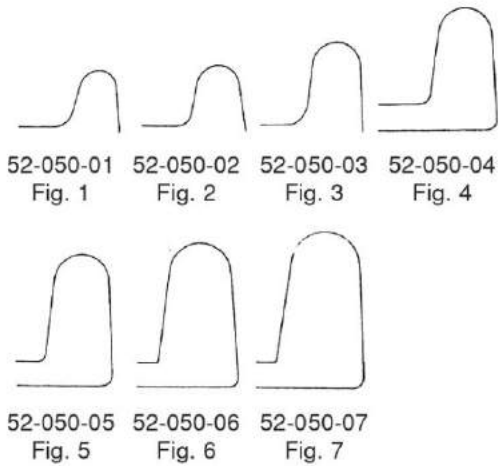

**VOLTOLINI**  
52-060-01 to 52-060-03



**HARTMAN-HALLE**  
52-102-01 to 52-102-03  
15 cm, 6"

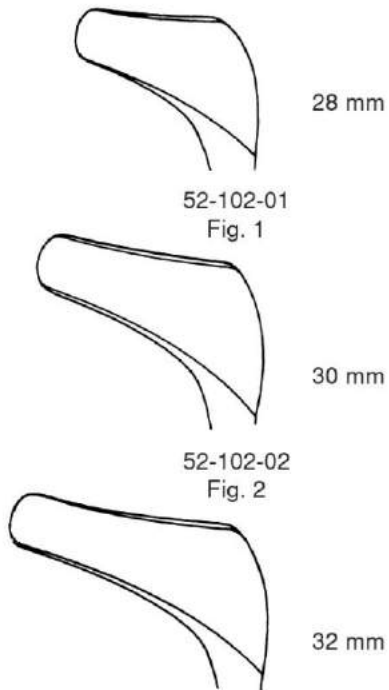

**VIENNA**  
14.6 cm., 5<sup>3</sup>/<sub>4</sub>"  
52-112-01  
52-112-02  
52-112-03



**VIENNA**  
52-113-03  
Lightweight

Small  
Medium  
Large

Nasal Specula  
Espéculos nasales



52-103-01  
16 cm, 6 1/4"



52-103-02  
16 cm, 6 1/4"



52-103-03  
16 cm, 6 1/4"



HARTMAN



## Nasal Specula, Laryngeal Mirrors Especúlos nasales, espejos laríngeos

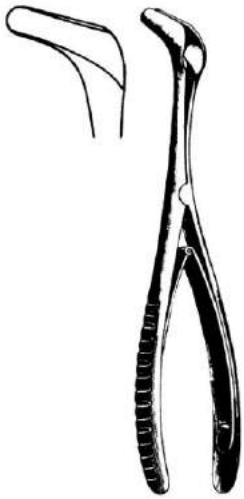

TIECK-HALLE  
52-116-13  
13.5 cm, 5 1/4"



BECKMAN  
52-118-13  
12.5 cm, 5"



KILLIAN  
52-120-35 to 52-120-90  
13 cm, 5 1/8"

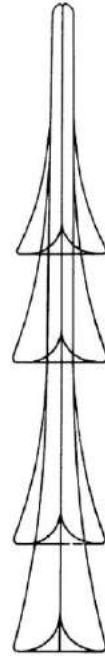

52-120-35  
35 mm

52-120-50  
50 mm

52-120-75  
75 mm

52-120-90  
90 mm



COTTLE  
52-124-35 to 52-124-90  
14 cm, 5 1/2"

52-124-35 35 mm  
52-124-50 50 mm  
52-124-75 75 mm  
52-124-90 90 mm

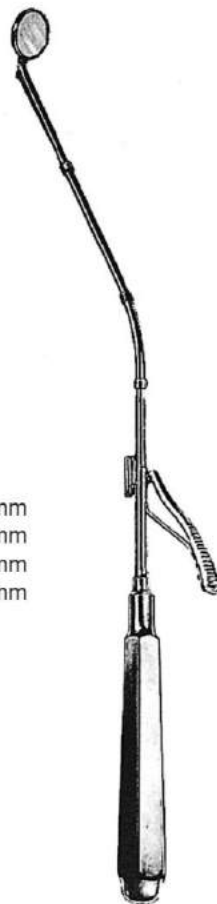

MICHEL  
52-139-12 to 52-139-18  
25 cm, 10"



52-139-12  
12 mm



52-139-14  
14 mm



52-139-16  
16 mm



52-139-18  
18 mm



Nasal Dressing Forceps, Nasal Polyp Forceps  
 Pinzas auriculares, Pinzas para pólipos

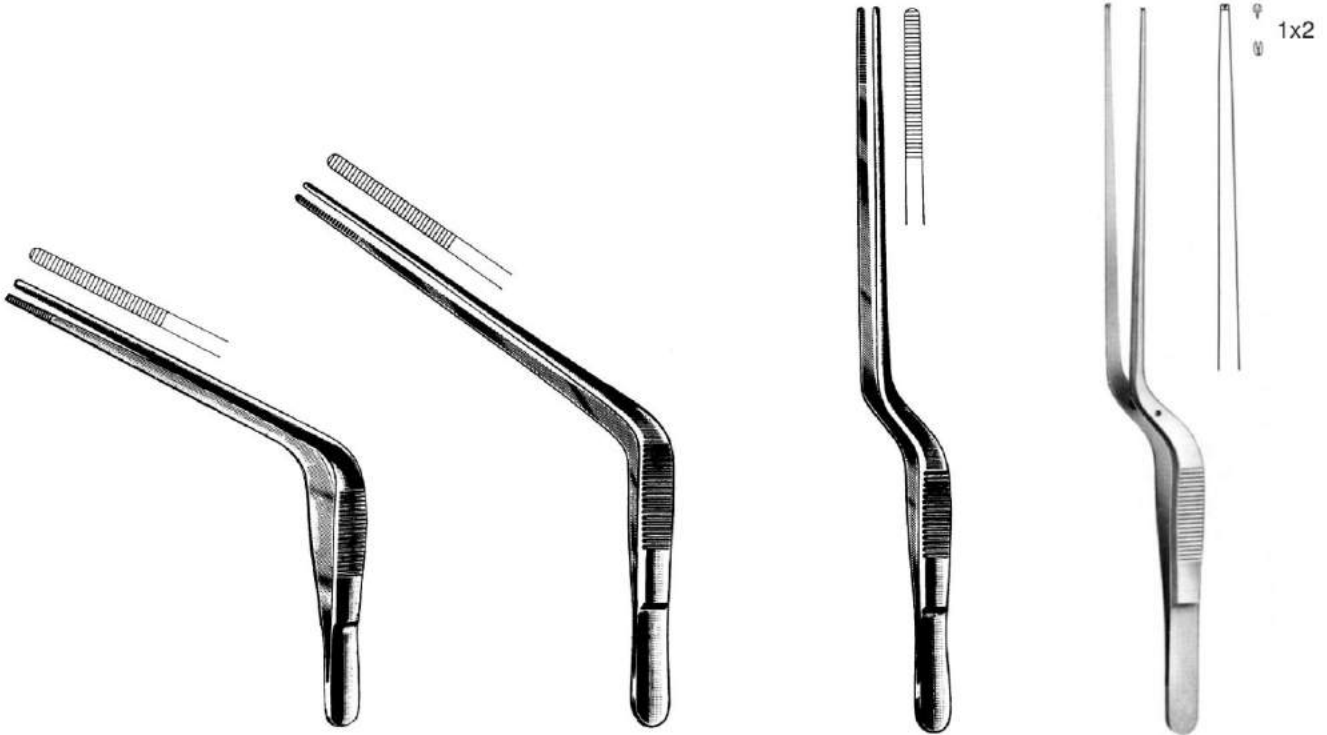

WILDE  
 52-151-15  
 15 cm, 6"

WILDE(TROELTSCH)  
 52-151-18  
 18 cm, 7"

JANSEN  
 52-154-20  
 20 cm, 8"

JANSEN  
 52-155-20  
 20 cm, 8"



WESTMACOTT  
 52-158-20  
 20 cm, 8"

LUBET-BARBON  
 52-159-20  
 20 cm, 8"

HARTMAN  
 52-161-16  
 16 cm, 6 1/4"

HARTMAN  
 52-161-20  
 20 cm, 8"





Nasal Polyp and Septum Forceps  
Pinzas para pólipos y para el tabique nasal

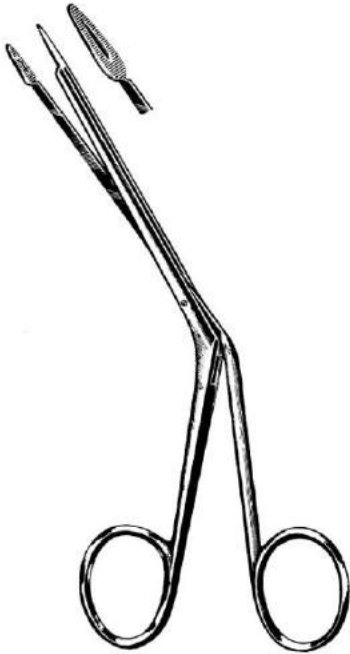

LITTAUER  
52-167-18  
18 cm, 7"

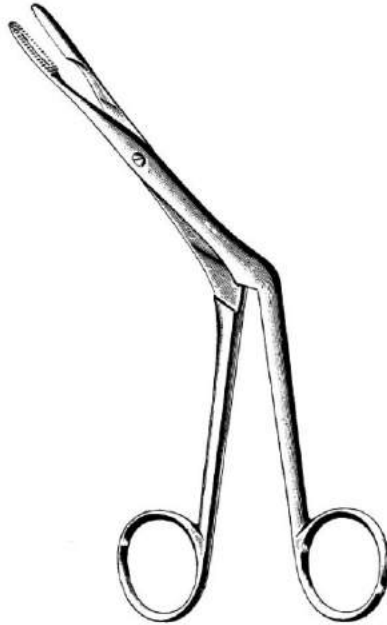

HEYMAN-KNIGHT  
52-169-18  
18 cm, 7"



NOYES  
52-171-14 52-173-14  
14.5 cm, 5 3/4"



HEYMAN  
52-181-18  
18 cm, 7"

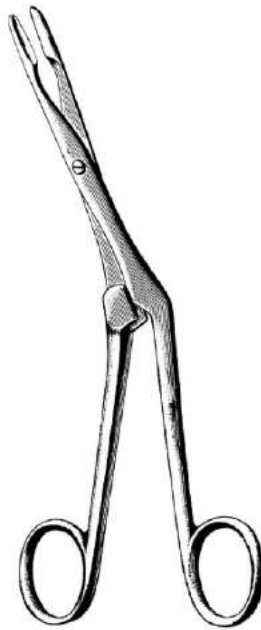

KNIGHT  
52-185-18  
18 cm, 7"

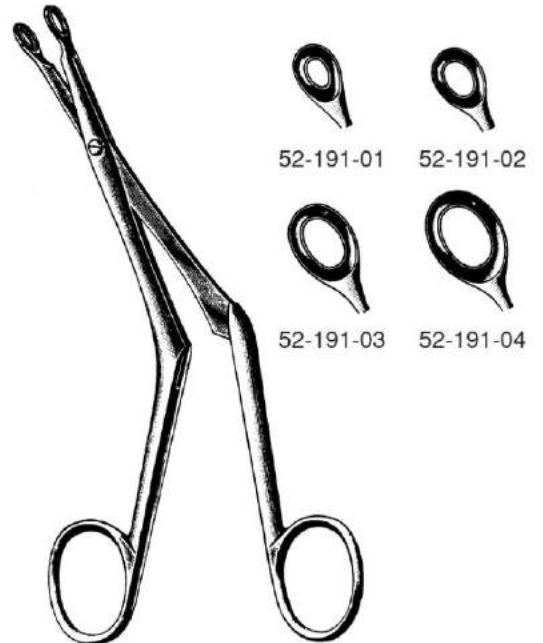

BRUENINGS  
52-191-01 to 52-191-04  
19 cm, 7 1/2"



Nasal Cutting Forceps  
Pinzas cortantes nasales



GRAIG  
52-192-16  
16 cm, 6 1/4"

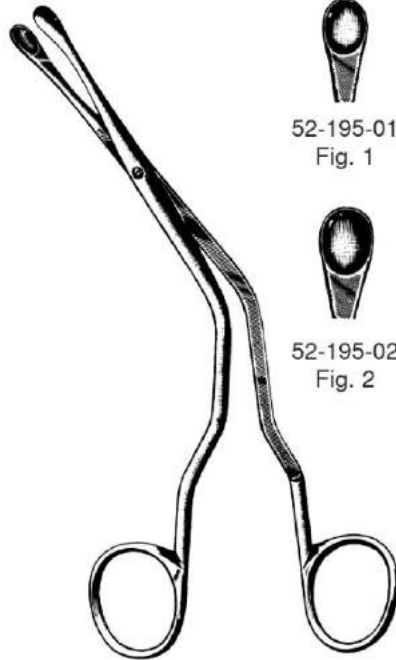

LUC  
52-195-01 52-195-02  
19 cm, 7 1/2"

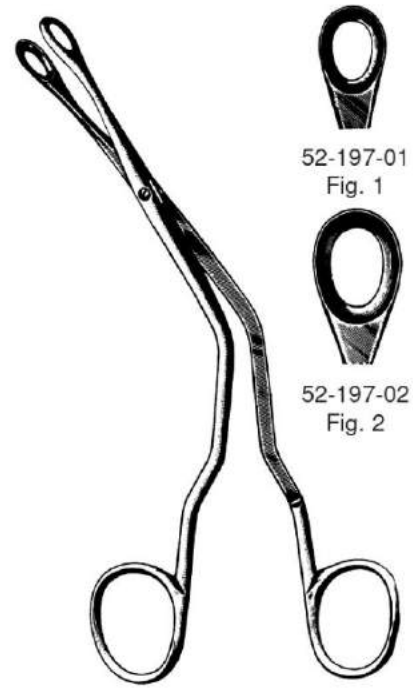

LUC  
52-197-01 52-197-02  
19 cm, 7 1/2"

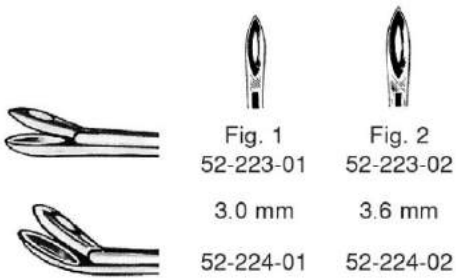

Fig. 1	Fig. 2
52-223-01	52-223-02
3.0 mm	3.6 mm
52-224-01	52-224-02

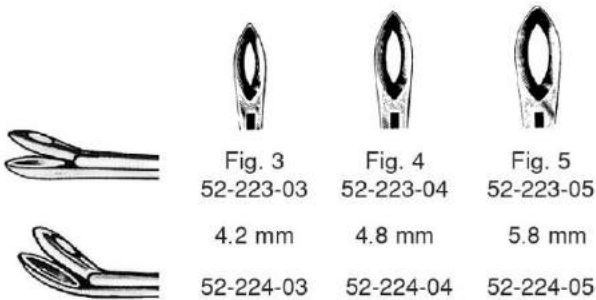
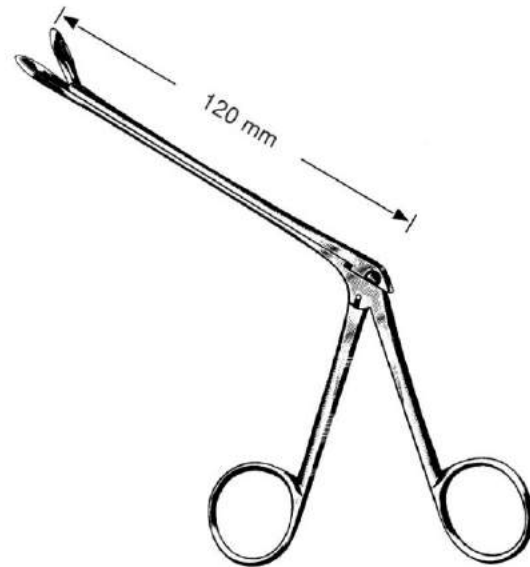

Fig. 3	Fig. 4	Fig. 5
52-223-03	52-223-04	52-223-05
4.2 mm	4.8 mm	5.8 mm
52-224-03	52-224-04	52-224-05



WEIL-BLAKESLEY  
52-223-01 to 52-224-05



Nasal Cutting Forceps  
Pinzas cortantes nasales

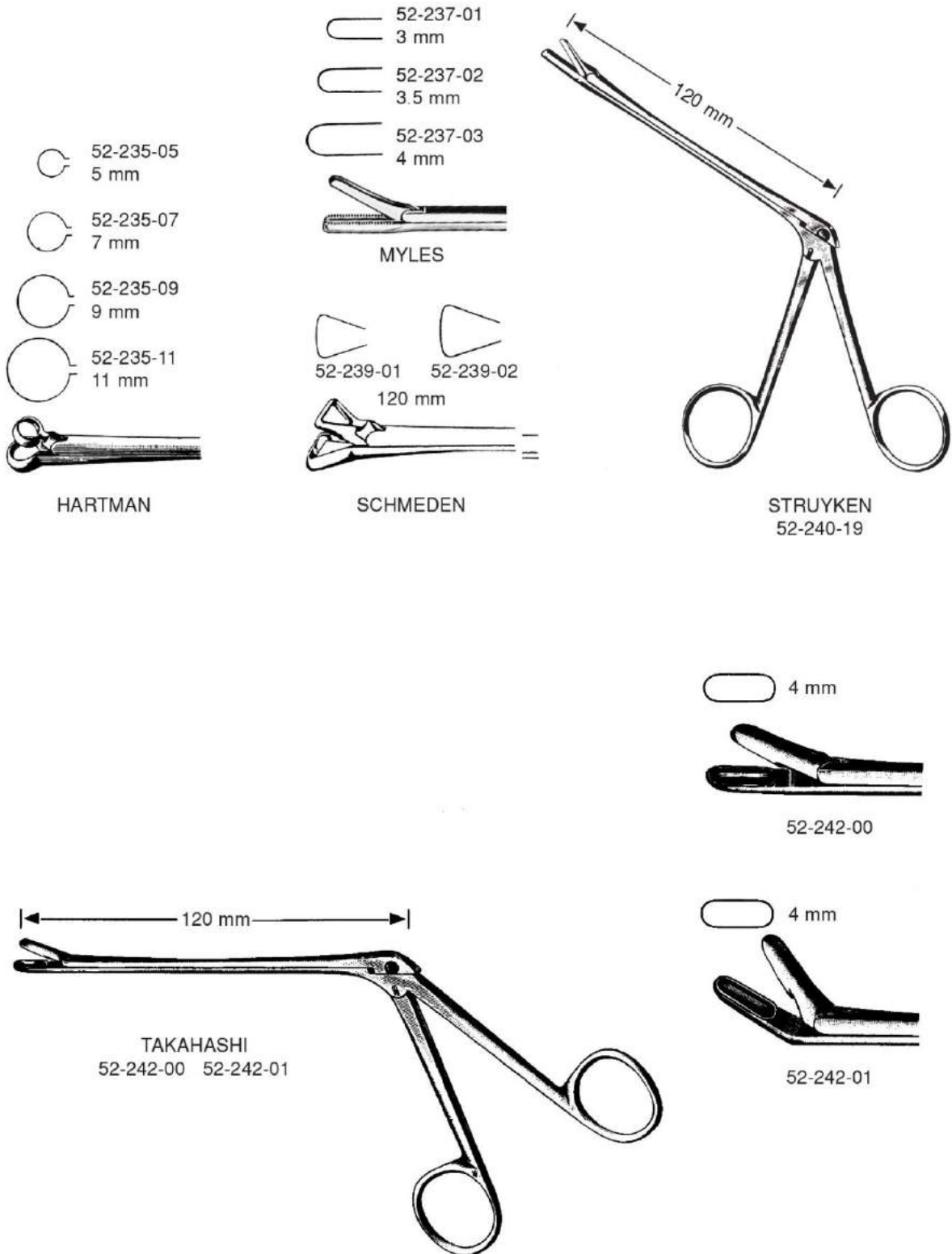



Nasal Cutting, Septum and Polyp Forceps, Rongeurs  
 Pinzas cortantes nasales, Pinza para magullar tabique, Pinzas cortantes para maxilares



RUBIN  
 52-251-21  
 21 cm, 8 1/4"

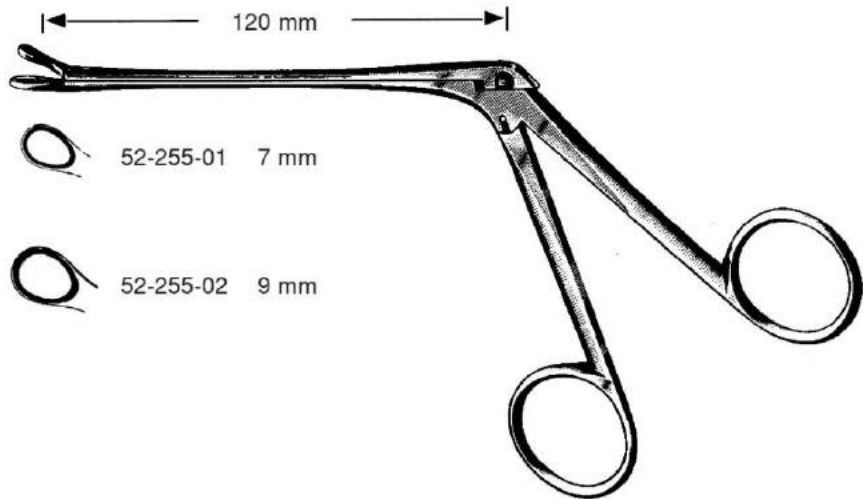

WATSON-WILLIAMS  
 52-255-01

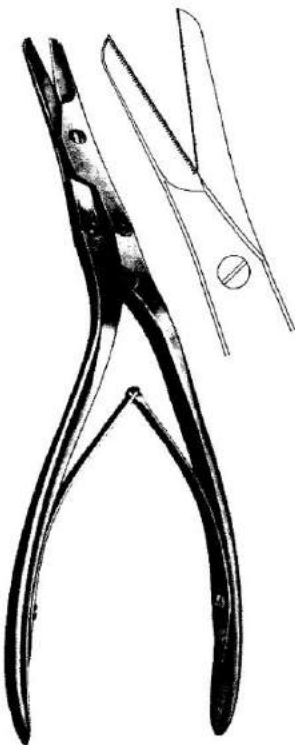

CAPLAN  
 52-256-20  
 20 cm, 8"



KERRISON  
 3 x 3 mm 52-303-03  
 4 x 4 mm 52-303-04  
 5 x 5 mm 52-303-05  
 6 x 6 mm 52-303-06  
 17 cm, 6 3/4"



Nasal Cutting Scissors, Antrum Punch Forceps  
Pinzas cortantes nasales, Pinzas cortantes para maxilares

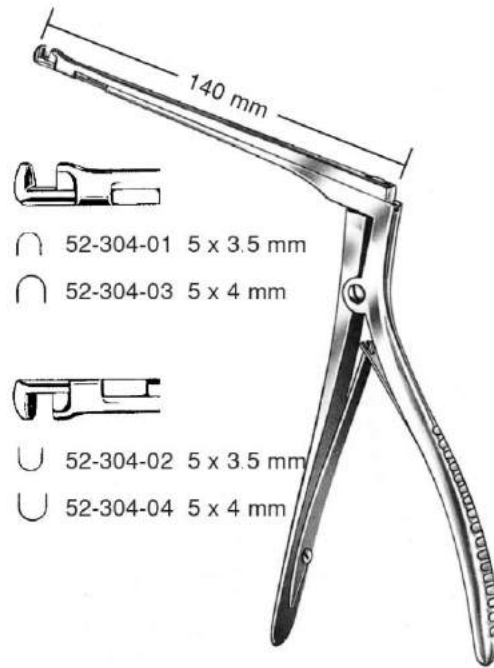

52-304-01 5 x 3.5 mm

52-304-03 5 x 4 mm

52-304-02 5 x 3.5 mm

52-304-04 5 x 4 mm

HAJEK-KOFLER  
52-304-01 to 52-304-04



Killian  
58-102-20  
20cm, 8"

110 mm

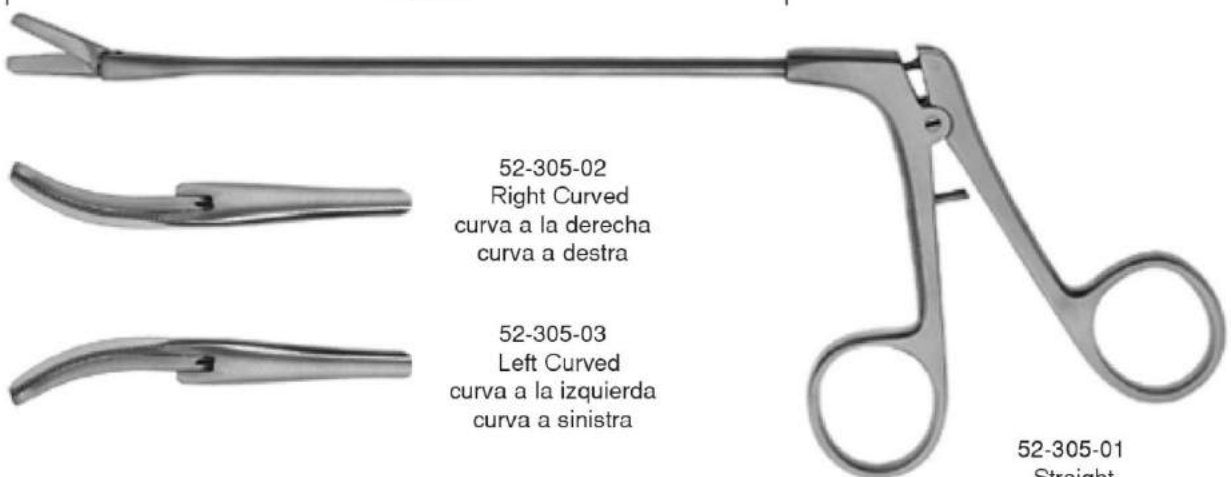

52-305-02  
Right Curved  
curva a la derecha  
curva a destra

52-305-03  
Left Curved  
curva a la izquierda  
curva a sinistra

52-305-01  
Straight  
recta  
retta



## Punches, Septum Forceps

Pinzas osteótomas, Pinzas para el tabique nasal



CITELLI

- 52-311-10 1.0 mm
- 52-311-25 2.5 mm
- 52-311-30 3.0 mm

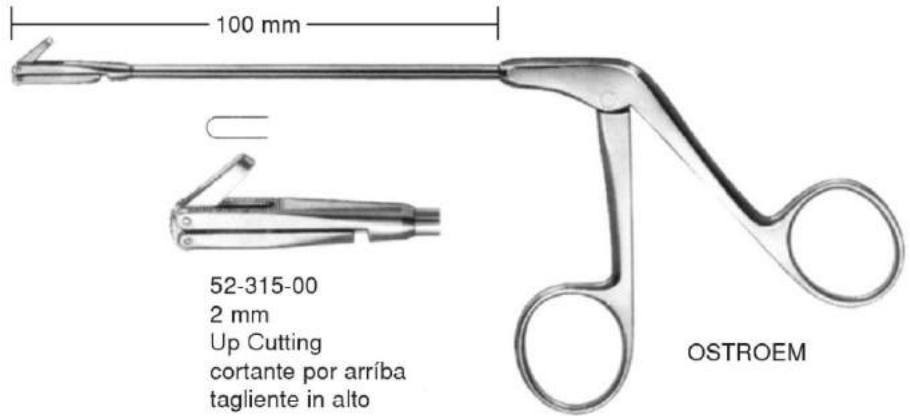

OSTROEM

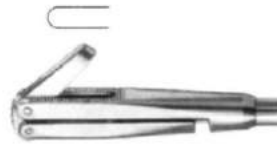

52-315-00  
2 mm  
Up Cutting  
cortante por arriba  
tagliente in alto

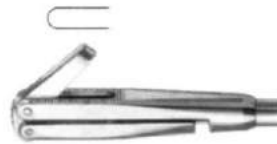

52-316-00  
2 mm  
Right Cutting  
cortante a la derecha  
tagliente a destra



52-317-00  
2 mm  
Left Cutting  
cortante a la izquierda  
tagliente a sinistra

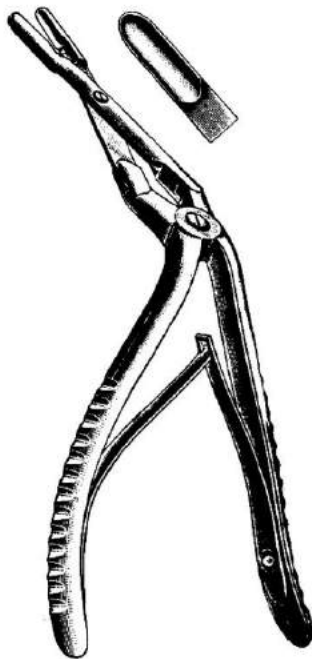

MIDDLETON-JANSEN  
52-323-19  
19 cm, 7 1/2"



MIDDLETON-JANSEN  
52-325-19  
19 cm, 7 1/2"



## Sinuscopy Forceps Pinzas para senoscopia

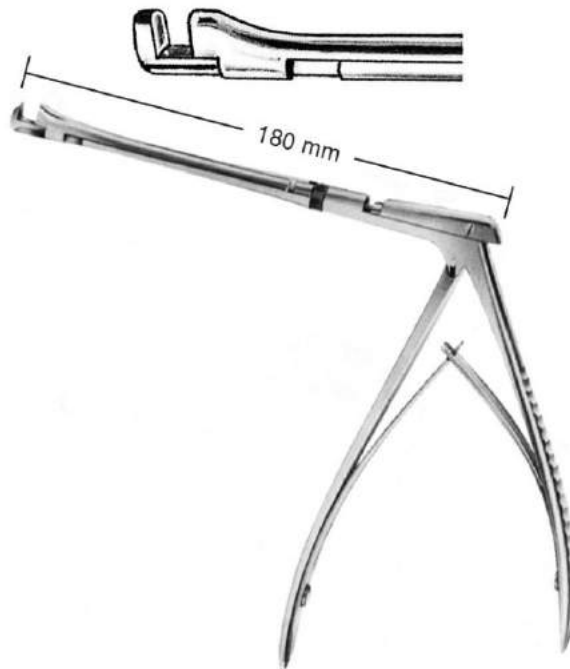

HAJEK-KOFLER  
52-316-16  
3.5 mm

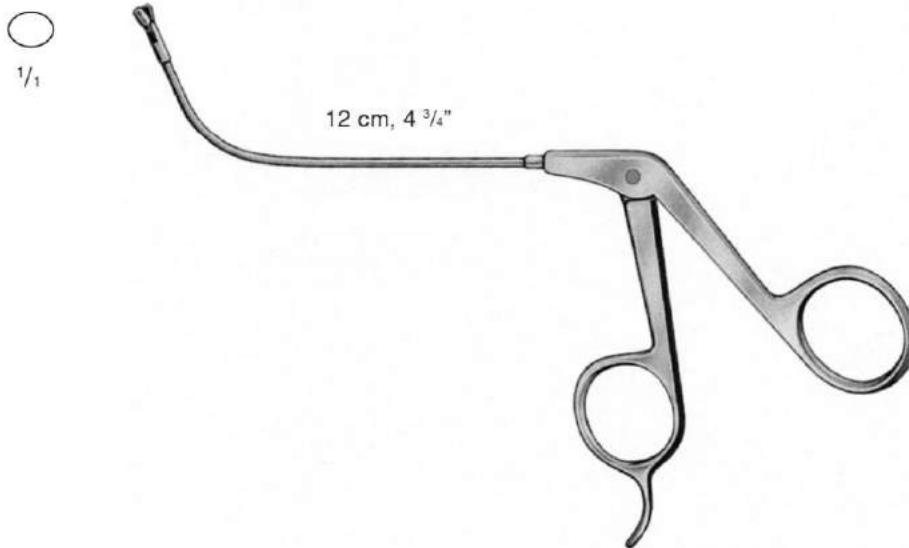

Jaw boca morso		Horizontal Cutting abierta horizontal apertura orizzontale	Vertical Cutting abierta vertical apertura verticale
65°	○ 3 mm Round	52-317-65	52-318-65
70°	◌	52-317-70	52-318-70
90°	◌	52-317-90	52-318-90
110°	◌ } Oval	52-317-11	52-318-11

Circular Forceps  
Pinza circular



52-319-35 3.5mm  
52-319-45 4.5mm





**Antrum and Frontal Sinus Wash Cannulas**  
**Cánulas lavadoras para seno maxilar y seno frontal**

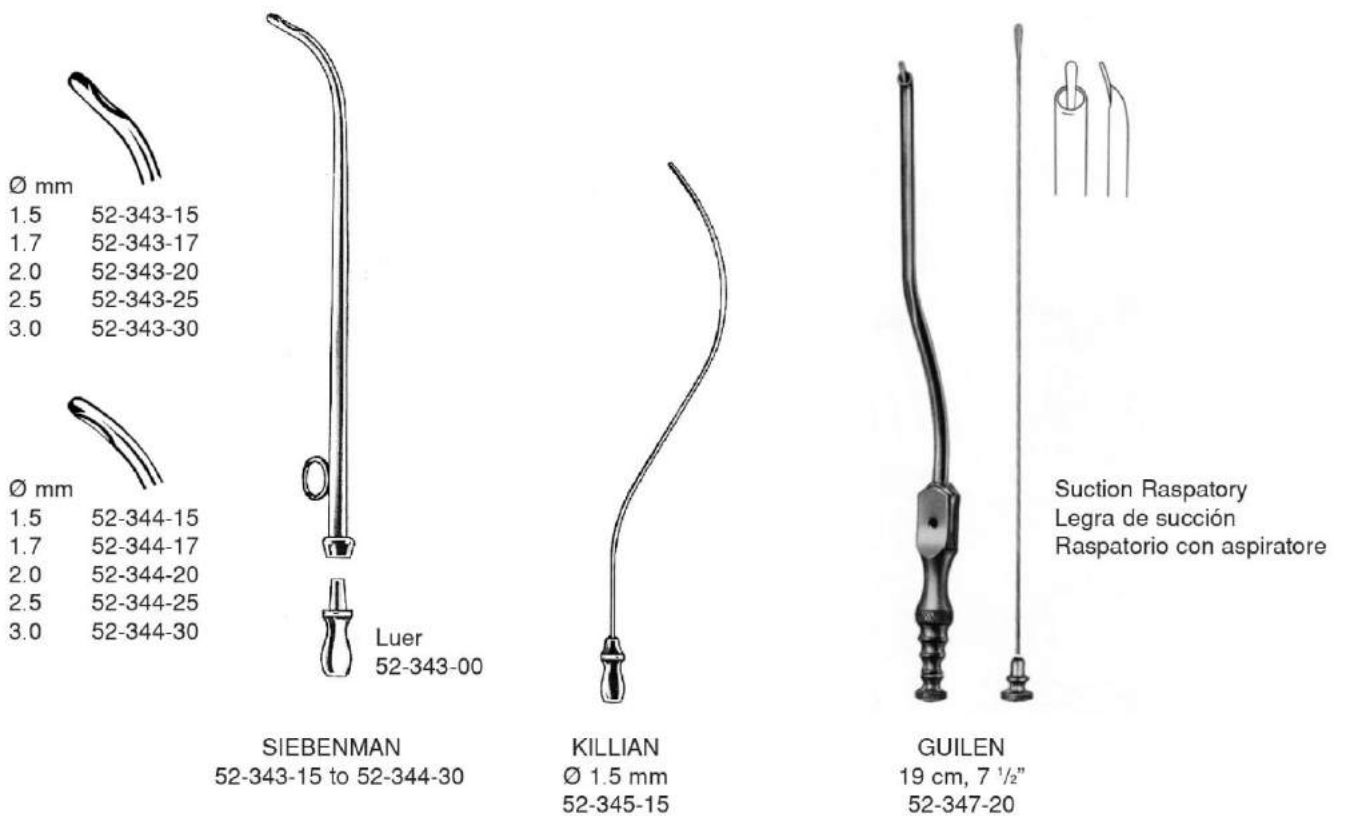
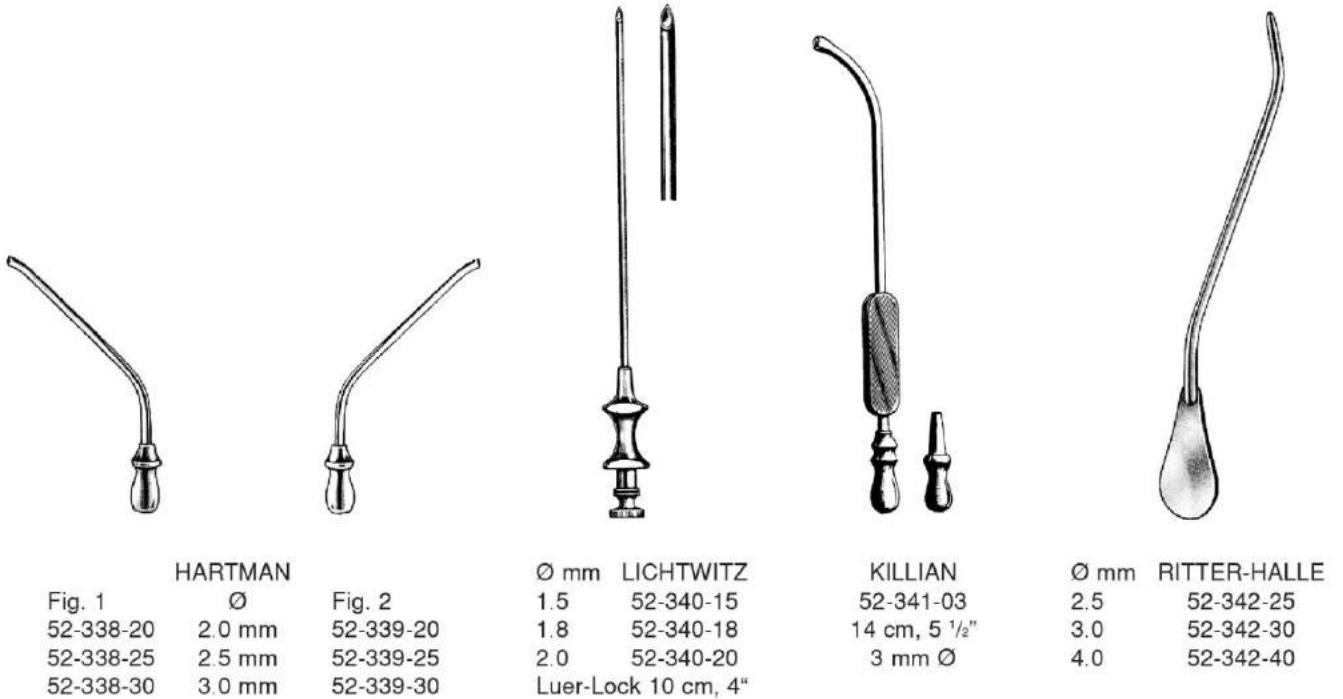



Nasal Snares, Nasal Knives  
Polipótomos, Bisturios nasales



KRAUSE-VOSS  
52-350-26  
26 cm, 10 1/4"



KRAUSE  
52-351-26  
26 cm, 10 1/4"



WILDE  
52-352-24  
24 cm, 9 1/2"



Pkg/12

52-355-03 0.3 mm



JOSEPH  
52-370-16 to 52-373-16



52-370-16 52-371-16  
Blunt  
romos, smussi



52-372-16 52-373-16  
Sharp  
agudos, acuti



FREER  
52-374-16  
16.5 cm, 6 1/4"

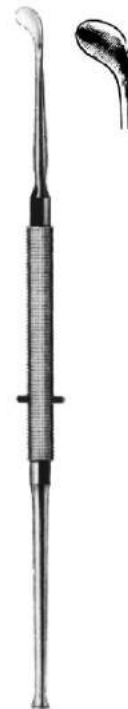

FREER  
52-375-19  
19 cm, 7 1/2"



JOSEPH  
52-375-16  
16.5 cm, 6 1/2"



Rhinoplastic and Nasal Knives, Septum Sickle Knives, Curettes  
Bisturios para plastica y operaciones de la nariz, Bisturios para el tabique nasal, Curetos

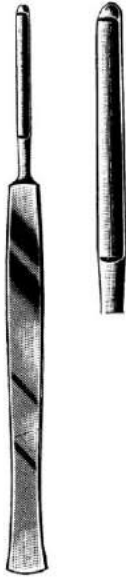

JOSEPH  
52-376-16  
16 cm, 6 1/4"

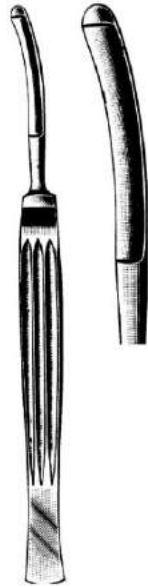

CONVERSE  
52-379-16  
16 cm, 6 1/4"



COTTLE  
52-380-15  
15 cm, 6"



COTTLE  
52-382-15



JOSEPH  
52-384-15



JOSEPH  
52-385-15



52-386-01  
Sharp  
agudo  
acuto



52-386-02  
Blunt  
romo  
smusso

19 cm, 7 1/2"



52-387-01  
Forward Cutting  
corte hacia adelante  
taglio in avanti



52-387-02  
Backward Cutting  
corte hacia atras  
taglio retrograde

BOOTNAS  
19 cm, 7 1/2"



Septum Swivel Knives  
Bisturías para el tabique nasal

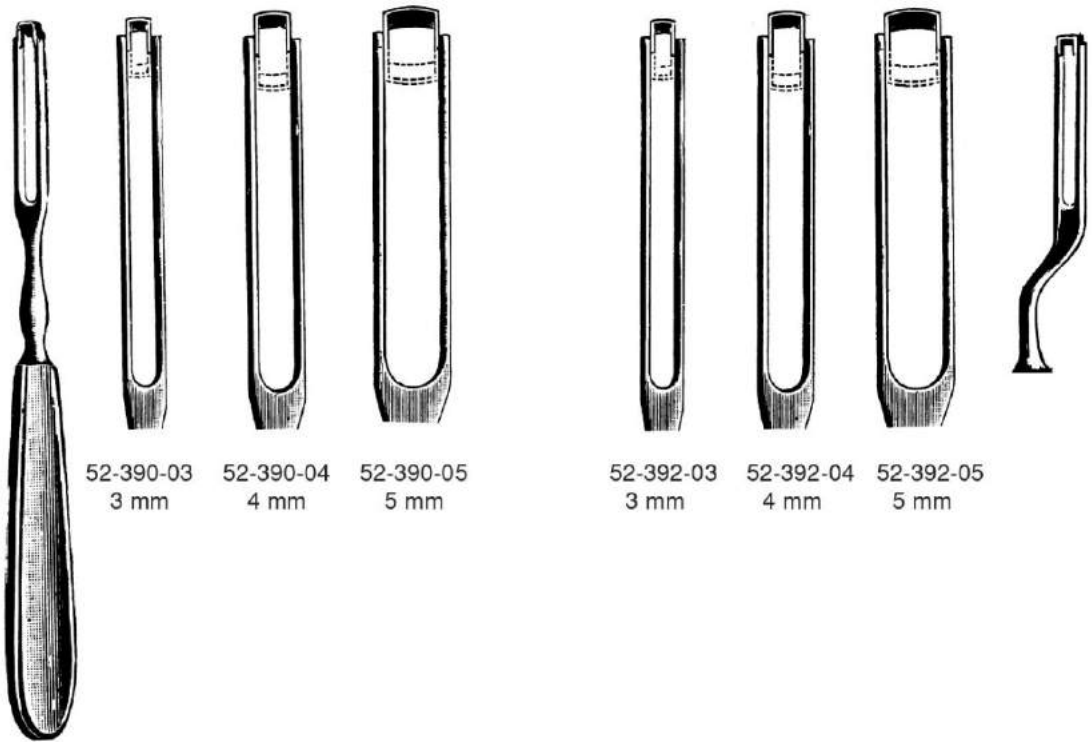

BALLENGER  
52-390-03 to 52-392-05  
20 cm, 8"



Septum Elevators  
Elevadores para el tabique



HALLE  
52-410-16  
16.5 cm, 6 1/2"



McKENTY  
52-410-04 52-410-05  
15 cm, 6"

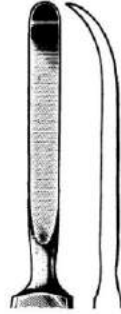

52-410-04  
4 mm

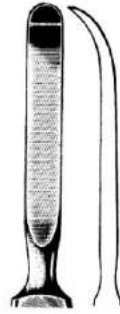

52-410-05  
5 mm



JOSEPH  
52-411-16  
16 cm, 6 1/4"



ROGER  
52-413-19  
19 cm, 7 1/2"



FREER  
52-415-18  
18 cm, 7"



FREER  
52-417-19  
19 cm, 7 1/2"



FREER  
52-419-19  
19 cm, 7 1/2"



Septum Elevators  
Elevadores para el tabique



KILLIAN  
52-420-01  
18.5 cm, 7 1/4"



PIERCE  
52-420-02  
21 cm, 8 1/4"

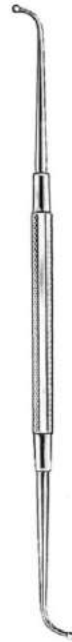

SINUS  
52-420-03  
18 cm, 7"

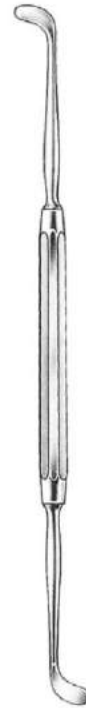

PENNINGTON  
52-420-04  
21 cm, 8 1/4"



McKENTY  
52-420-20  
22 cm, 8 3/4"



HOWARTH  
52-421-21  
21.5 cm, 8 1/2"



Septum Elevators  
Elevadores para el tabique



**COTTLE-JOSEPH**  
52-422-22  
22 cm, 8 3/4"

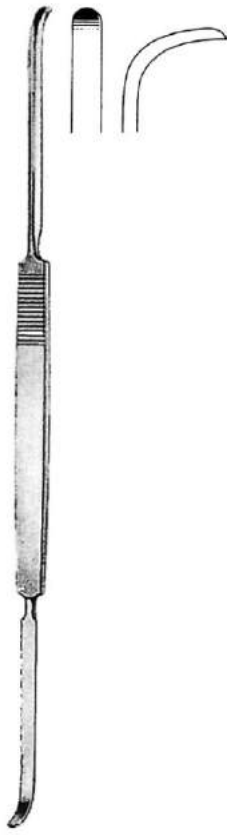

**COTTLE**  
52-421-23  
23 cm, 9"



**COTTLE**  
52-423-22  
22 cm, 8 3/4"

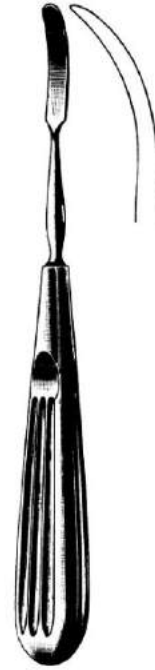

**COTTLE**  
52-424-16  
16 cm, 6 1/4"



**COTTLE**  
52-425-19  
19 cm, 7 1/2"



**KILLIAN**  
52-426-22  
22 cm, 8 3/4"

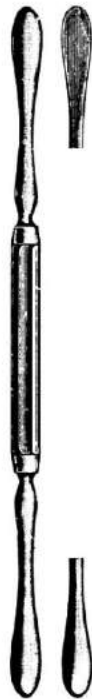

**HAJEK-BALLENGER**  
52-428-21  
22 cm, 8 3/4"



**BALLENGER**  
52-430-22  
22 cm, 8 3/4"



**FREER**  
52-450-04



**FREER**  
52-451-04



Rhinoplastic Chisels & Osteotomes  
Cinceles para la plástica nasal

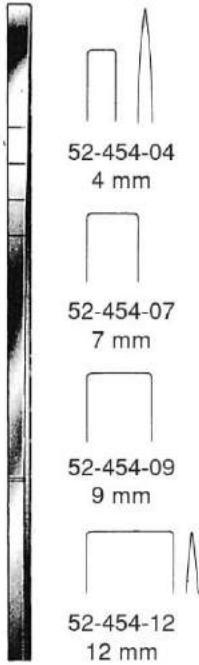

52-454-04  
4 mm

52-454-07  
7 mm

52-454-09  
9 mm

52-454-12  
12 mm

COTTLE  
52-454-04 to 52-454-12  
18 cm, 7"



6 mm

COTTLE  
52-455-06  
18 cm, 7"



52-458-04  
4 mm

52-458-07  
7 mm

52-458-09  
9 mm

52-458-12  
12 mm

COTTLE  
52-458-04 to 52-458-12

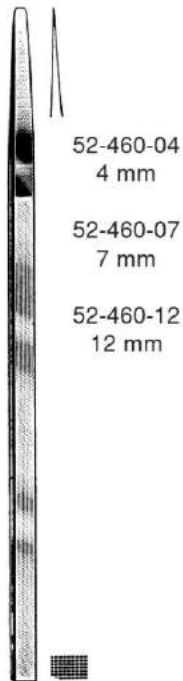

52-460-04  
4 mm

52-460-07  
7 mm

52-460-12  
12 mm

COTTLE  
52-460-04 to 52-460-12  
18 cm, 7"

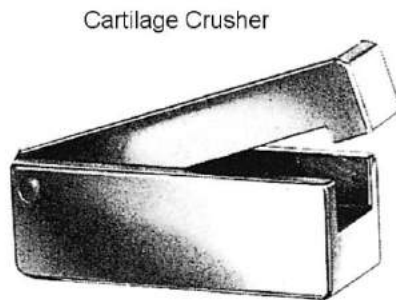

Cartilage Crusher

COTTLE  
52-461-00





## Rhinoplastic Chisels & Osteotomes Cinceles para la plàstica nasal

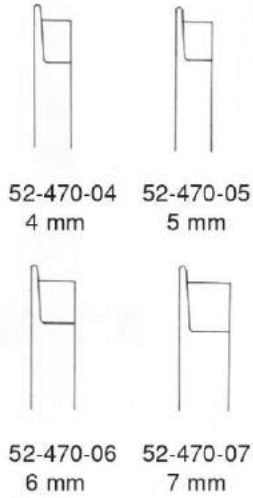

52-470-04 4 mm  
52-470-05 5 mm

52-470-06 6 mm  
52-470-07 7 mm

**FOMON**  
52-470-04 to 52-470-07  
17 cm, 6 3/4"

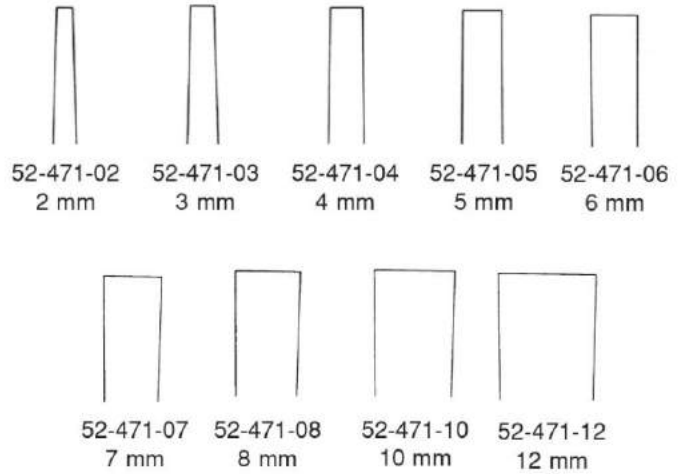

52-471-02 2 mm  
52-471-03 3 mm  
52-471-04 4 mm  
52-471-05 5 mm  
52-471-06 6 mm

52-471-07 7 mm  
52-471-08 8 mm  
52-471-10 10 mm  
52-471-12 12 mm

**SHEEHAN**  
52-471-02 to 52-471-12  
16 cm, 6 3/4"

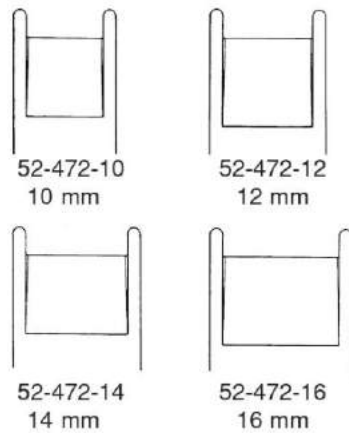

52-472-10 10 mm

52-472-12 12 mm

52-472-14 14 mm

52-472-16 16 mm

**CINELLI**  
52-472-10 to 52-472-16



## Rhinoplastic Chisels & Osteotomes Cinceles para la plástica nasal

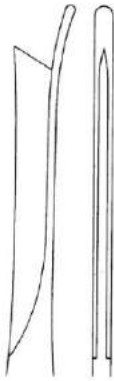

Straight

SILVER  
52-473-01  
18 cm, 7"

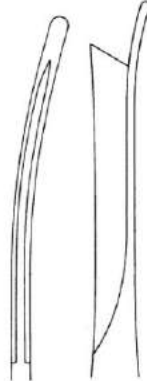

Right

SILVER  
52-473-02  
18 cm, 7"

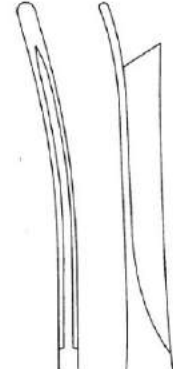

Left

SILVER  
52-473-03  
18 cm, 7"



5 mm

KILLIAN  
52-481-05  
16 cm, 6 1/4"



5 mm

KILLIAN-CLAUS  
52-482-05  
17 cm, 6 3/4"



mm	H AJEK
4	52-484-04
6	52-484-06
8	52-484-08



WEST  
52-486-16  
16 cm, 6 1/4"



WEST  
52-487-16  
16 cm, 6 1/4"



6 mm



FREER  
52-489-16  
16 cm, 6 1/4"



Nasal Rasps  
Escofinas nasales

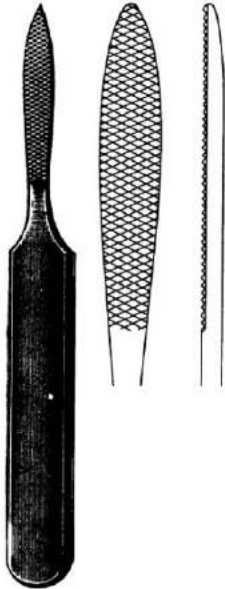

JOSEPH  
52-502-16  
16 cm, 6 1/4"

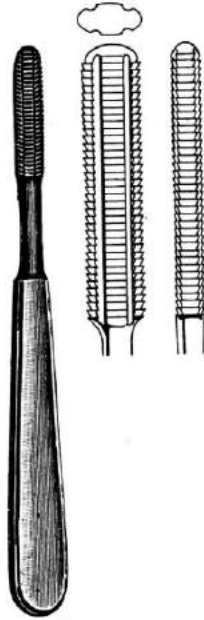

MALTZ  
52-504-18  
18 cm, 7"



WIENER  
52-507-17 52-507-19  
18 cm, 7"



52-507-17



52-507-19



AUFRICHT  
52-511-21 52-513-21  
21 cm, 8 1/4"



52-511-21



52-513-21



52-514-16  
Fine  
fine, fina



52-516-16  
Coarse  
gruesa, groasa



LEWIS (JOSEPH)  
52-514-16 52-516-16  
18 cm, 7"

Nasal Rasps  
Escofinas nasales



MALTZ (COTTLE)  
52-518-21  
21 cm, 8 1/4"

FOMON  
52-520-21  
21 cm, 8 1/4"

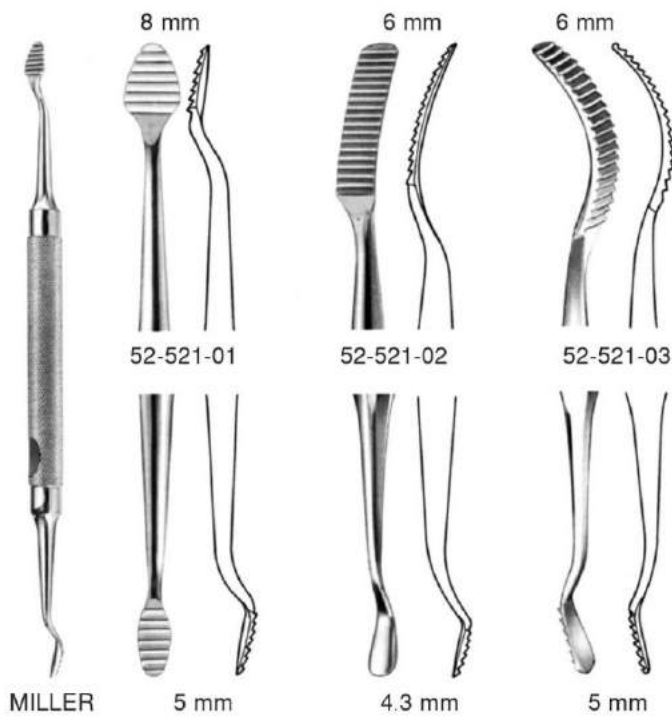



Tungsten Carbide



FOMON

52-522-01 to 52-522-09 TC  
20 cm, 8"



1

Fig. 1/2  
52-522-01

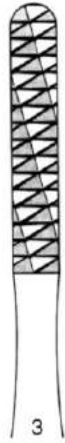

3

Fig. 3/4  
52-522-04

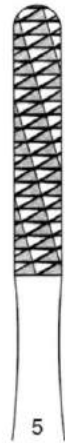

5

Fig. 5/6  
52-522-05

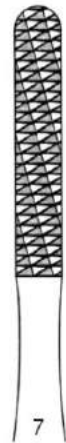

7

Fig. 7/8  
52-522-07



9

Fig. 9/10  
52-522-09



2

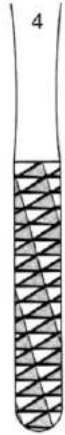

4

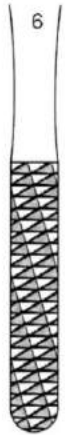

6

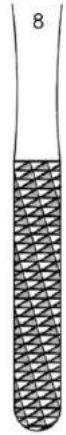

8



10



Nasal Rasps, Nasal Saws  
 Escofinas nasales, Sierras nasales



PEET  
 52-523-01 Straight  
 52-523-02 Curved



GALLAHER  
 52-526-16 to 52-529-16



Fig. 1  
 52-526-16

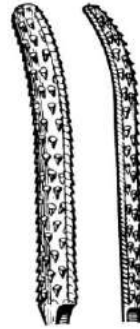

Fig. 2  
 52-527-16

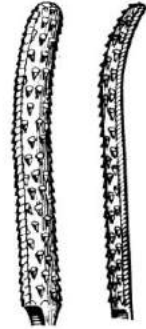
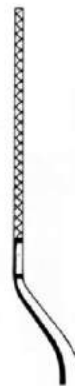

Fig. 3  
 52-529-16



JOSEPH  
 52-535-01 52-535-02  
 17 cm, 6 3/4"

Straight  
 redo  
 retta



Left  
 izquierda  
 a sinistra



Right  
 derecha  
 a destra



JOSEPH  
 52-532-19 19 cm, 7 1/2" 52-534-19  
 52-533-19



Nasal Retractors  
Retradores nasales, Ganchos para la piel



**COTTLE**  
52-540-16  
16 cm, 6 1/4"

60 x 6.5 mm



**AUFRICHT**  
52-542-12  
12 cm, 4 3/4"

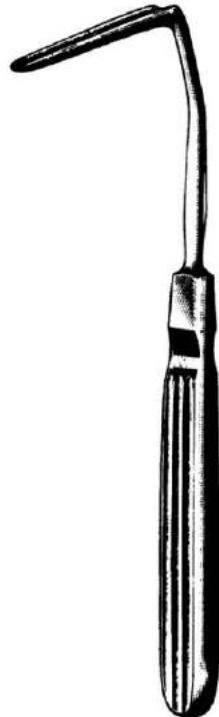

**AUFRICHT**  
52-551-16  
16 cm, 6 1/4"



**AUFRICHT**  
52-551-16L  
16 cm, 6 1/4"



**MASING-NEIVERT**  
52-552-16  
16 cm, 6 1/4"

10 x 12 mm



**COTTLE**  
52-553-15  
15 cm, 6"



**COTTLE**  
14.5 cm, 5 3/4"



52-554-01



52-554-02



52-554-03

3 x 11 mm



**KILNER**  
52-555-08  
8 cm, 3 1/8"

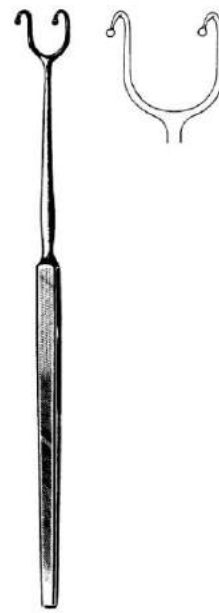

**FOMON**  
52-556-16  
16 cm, 6 1/4"



**FOMON**  
52-557-17  
17 cm, 6 3/4"



Skin Hooks, Retractor, Columnella Forceps  
Ganchos para la piel, Pinza para columnela



FREER  
52-558-15  
15 cm, 6"



COTTLE-NEIVERT  
52-559-20  
20 cm, 8"



Fig. 1 GILLIES  
52-560-18  
Fig. 2 52-562-18  
18 cm, 7"



Fig. 1



Fig. 2



LANGE  
52-563-22  
23 cm, 9"



COTTLE  
52-564-16  
16 cm, 6 1/4"



COTTLE  
52-565-10  
10 cm, 4"



CONVERSE  
52-566-12  
12 cm, 4 3/4"





Septum Straightening Forceps, Currettes  
Pinza para enderezar el tabique nasal, curetas

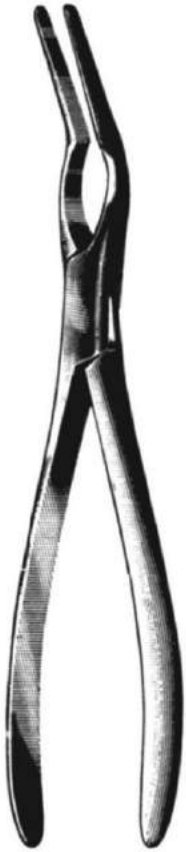

ASCH  
52-571-23  
23 cm, 9"

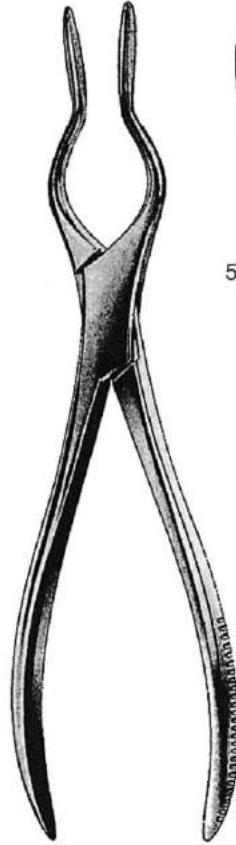

WALSHAM  
52-572-23 to 52-575-23  
23 cm, 9"



52-572-23  
Straight  
recta  
retta



52-573-23  
Left  
izquierda  
a sinistra



52-575-23  
Right  
derecha  
a destra

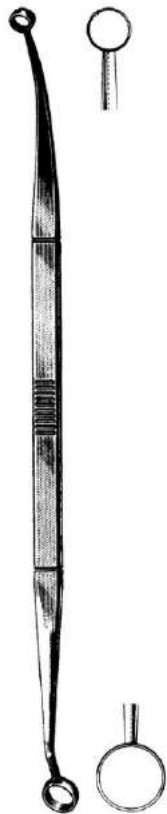

FAULKNER  
52-601-21  
21 cm, 8 1/4"



COAKLEY  
52-607-01 to 52-607-06  
17 cm, 6 3/4"



52-607-01  
Fig. 1



52-607-02  
Fig. 2



52-607-03  
Fig. 3



52-607-04  
Fig. 4



52-607-05  
Fig. 5



52-607-06  
Fig. 6



Adenoid Curettes  
Cuchillos para vegetaciones adenoides

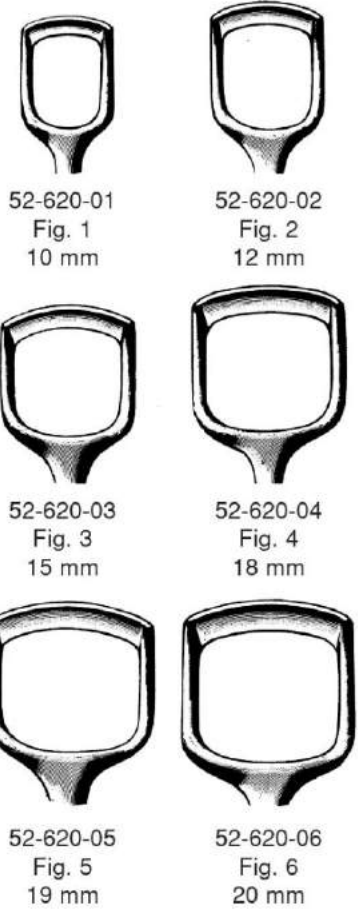

52-620-01 Fig. 1 10 mm  
52-620-02 Fig. 2 12 mm  
52-620-03 Fig. 3 15 mm  
52-620-04 Fig. 4 18 mm  
52-620-05 Fig. 5 19 mm  
52-620-06 Fig. 6 20 mm

BECKMANN  
52-620-01 to 52-620-06  
22 cm, 8 3/4"

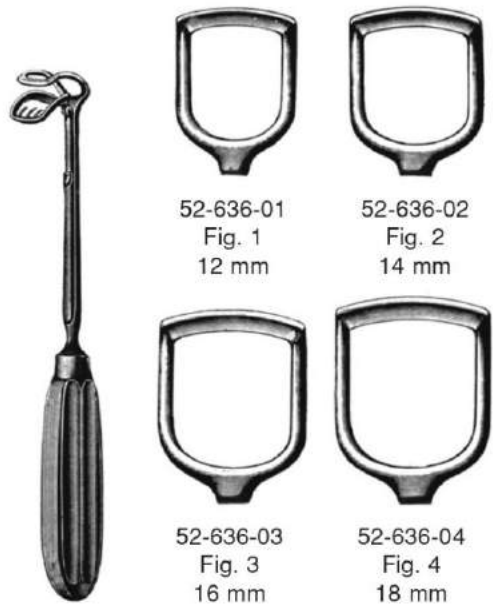

52-636-01 Fig. 1 12 mm  
52-636-02 Fig. 2 14 mm  
52-636-03 Fig. 3 16 mm  
52-636-04 Fig. 4 18 mm

St. CLAIR-THOMSON  
52-636-01 to 52-636-04  
21 cm, 8 1/4"

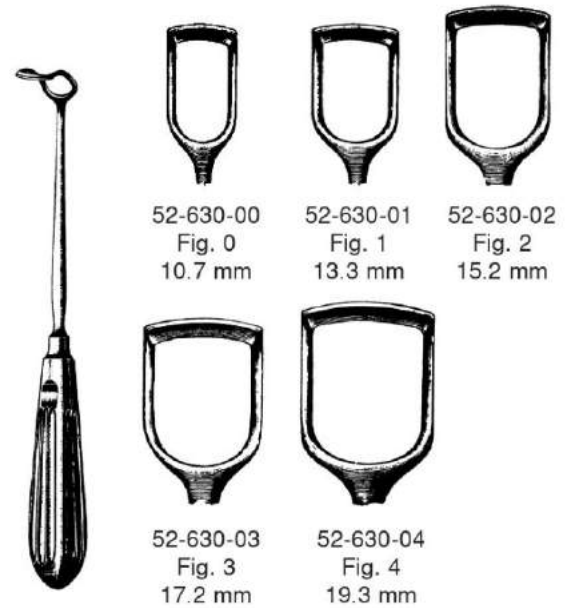

BARNHILL  
52-630-00 to 52-630-04  
21 cm, 8 1/4"

52-630-00 Fig. 0 10.7 mm  
52-630-01 Fig. 1 13.3 mm  
52-630-02 Fig. 2 15.2 mm  
52-630-03 Fig. 3 17.2 mm  
52-630-04 Fig. 4 19.3 mm



LAFORCE  
52-641-01 to 52-641-03  
25 cm, 10"

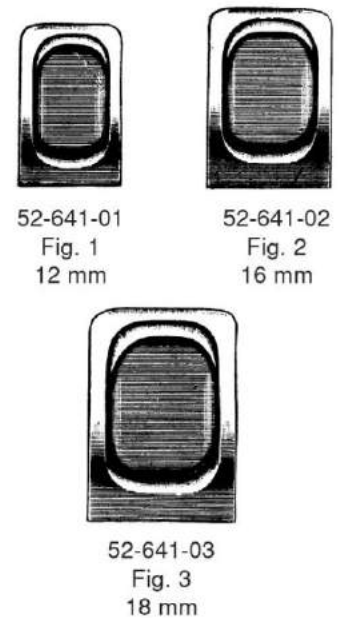

52-641-01 Fig. 1 12 mm  
52-641-02 Fig. 2 16 mm  
52-641-03 Fig. 3 18 mm

Spare Blades, Perforated  
Hojas de repuesto, perforadas  
Lame di ricambio, forate

Fig. 1 52-642-01  
Fig. 2 52-642-02  
Fig. 3 52-642-03



## Tongue Depressors, Cheek and Lip Retractors Baja-lenguas, Separadores para labios y mejillas

Wood  
madera  
legno



54-102-16  
16 cm, 6 1/4"  
Package of 100



MAYO  
54-103-17  
17 cm, 6 3/4"



KROENIG  
54-104-15  
15 cm, 6"



FRENZEL  
54-105-16  
16.5 cm, 6 1/2"

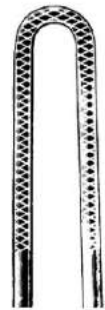

54-106-01  
14.5 cm, 5 3/4"



Angled  
54-106-02  
14.5 cm, 5 3/4"



BRUENINGS  
54-107-19  
19 cm, 7 1/2"



CAWOOD-MINNESOTA  
54-108-15  
15 cm, 6"



BUCHWALD  
54-109-19  
19 cm, 7 1/2"

Tongue Depressors  
Baja-lenguas



MORITZ-SCHMIDT  
54-110-19  
19 cm, 7 1/2"

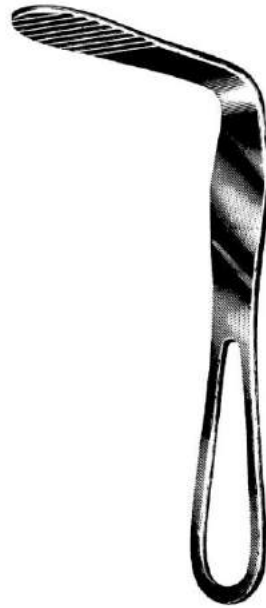

HARTMAN  
54-111-15  
15 cm, 6"



54-115-01  
Fig. 1  
14 cm, 5 1/2"



54-115-02  
Fig. 2  
15 cm, 6"



WIEDER  
54-115-01 54-115-02



ANDREW  
54-117-11  
11 cm, 4 3/8"



Tongue Depressor, Cheek and Lip Retractor, Tongue Holding Forceps  
Baja-lenguas, Separadores para labios y mejillas, Pinza tira-lenguas

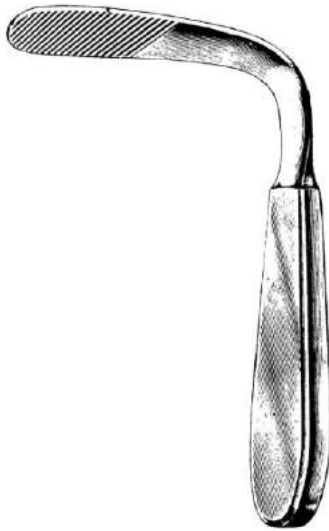

**TOBOLD**  
54-119-14  
14.5 cm, 5 3/4"

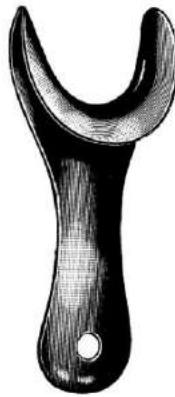

**SIMPLEX**  
54-230-11  
11 cm, 4 3/8"



**STERNBERG**  
54-231-12 12 cm, 4 3/4"  
54-231-14 14 cm, 5 1/2"  
54-231-16 16 cm, 6 1/4"



**LIP & CHEEK**  
54-235-19  
19 cm, 7 1/2"

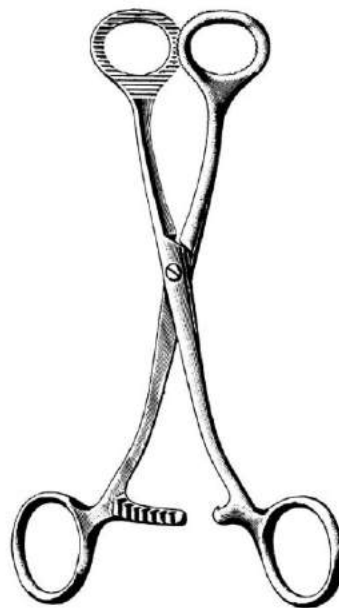

**COLLIN**  
54-250-16 16 cm, 6 1/4"  
54-250-18 18 cm, 7"



**YOUNG**  
54-255-16  
16 cm, 6 1/4"



54-255-99  
Spare Pair  
Repuesto (pareja)  
Ricambio (coppia)



Mouth Gags  
Abre-Bocas



54-310-08 Silicone Pads

MOLT (DOYEN-JANSEN)  
54-265-12  
12 cm, 4 3/4"

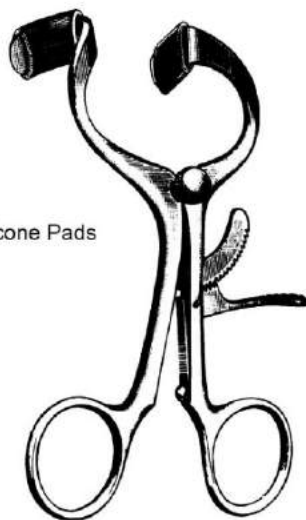

MOLT (DOYEN-JANSEN)  
54-265-14  
14 cm, 5 1/2"



DENHART  
54-267-12  
12 cm, 4 3/4"



ROSER-KOENIG  
54-270-16 16 cm, 6 1/4"  
54-270-19 19 cm, 7 1/2"

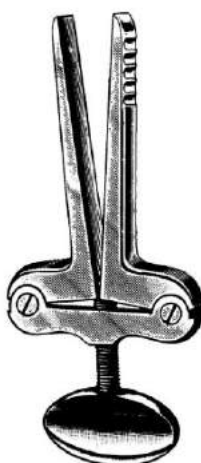

HEISTER  
54-272-13  
13 cm, 5 1/8"

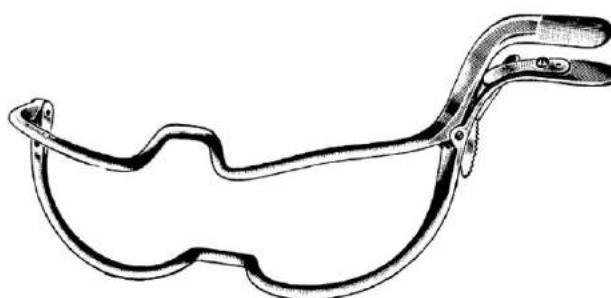

JENNINGS  
54-274-09 9 cm, 3 1/2"  
54-274-11 11 cm, 4 3/8"  
54-274-13 13 cm, 5 1/8"  
54-274-15 15 cm, 6"



Tongue Depressor, Mouth Gags  
Baja-lenguas, Abrebocas

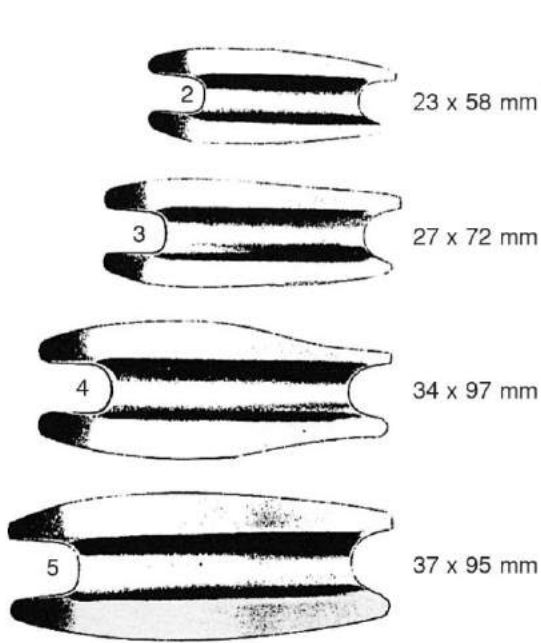

Left Side  
izquierda  
lato sinistro

Right Side  
derecha  
lato destro

	RING	
54-287-02	Fig. 2	54-288-02
54-287-03	Fig. 3	54-288-03
54-287-04	Fig. 4	54-288-04
54-287-05	Fig. 5	54-288-05

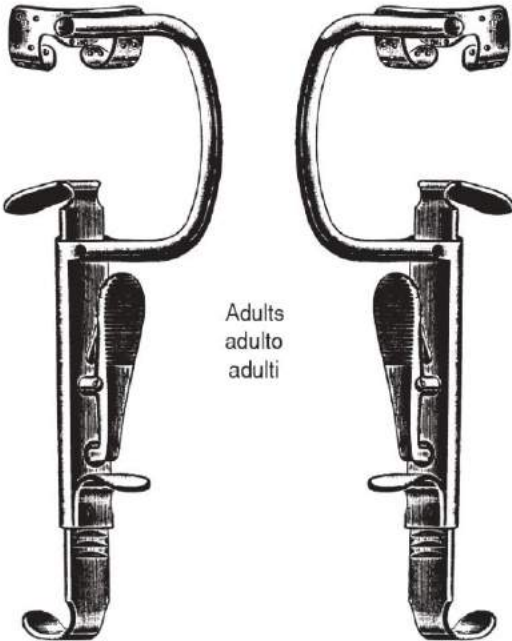

Adults  
adulto  
adulti

54-310-10  
Gag Only, Left  
Abre-boca suelta, izquierda  
Apribocca solo, sinistra

54-310-12  
Gag Only, Right  
Abre-boca suelta, derecha  
Apribocca solo, destra

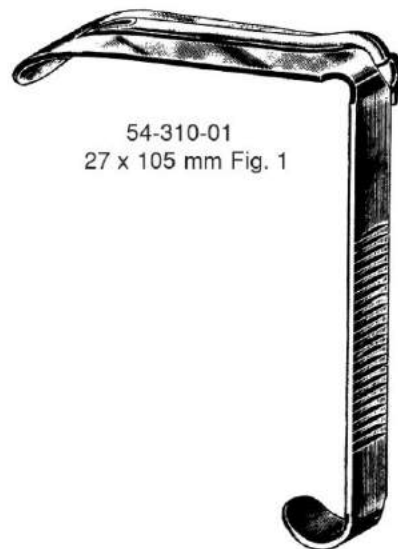

54-310-01  
27 x 105 mm Fig. 1

DAVIS-BOYLE  
54-310-00  
Complete

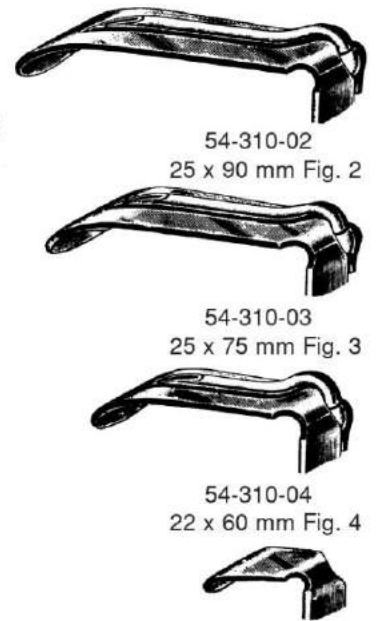

54-310-02  
25 x 90 mm Fig. 2

54-310-03  
25 x 75 mm Fig. 3

54-310-04  
22 x 60 mm Fig. 4

54-310-05  
20 x 25 mm Fig. 5



Mouth Gags  
Abre-Bocas

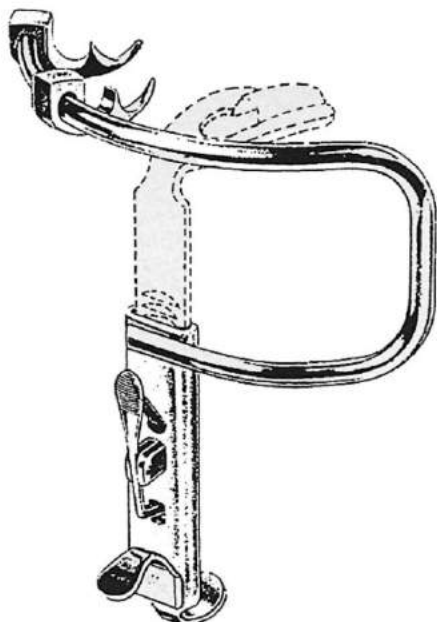

54-315-10  
Gag Only  
Abre-boca solo  
Apribocca solo

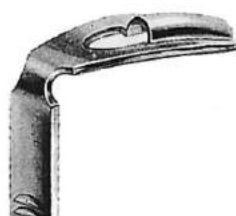

54-315-01  
Fig. 1



54-315-02  
Fig. 2



54-315-03  
Fig. 3

KILNER-DOUGHTY  
54-315-00  
Complete

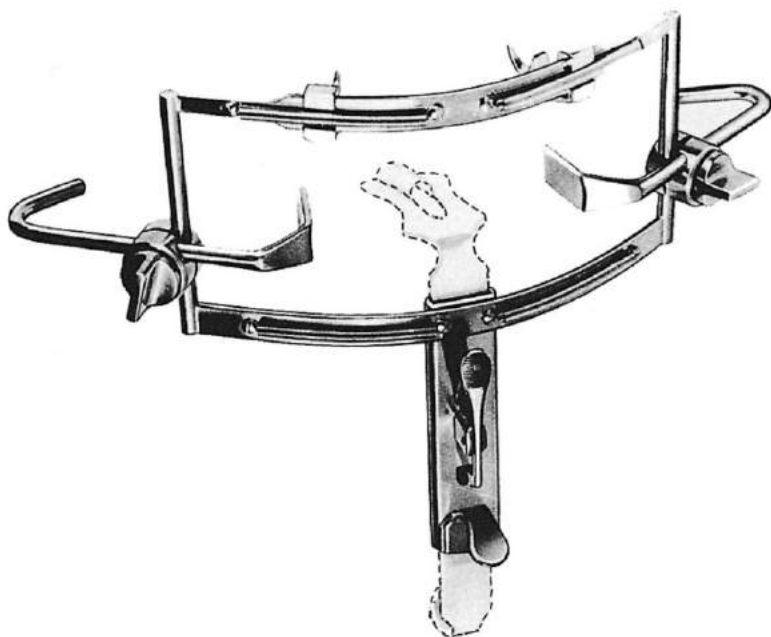

DINGMAN  
54-317-10  
Gag Only  
Abre-boca solo, Apribocca solo

54-317-00 Complete  
with 3 interchangeable tongue depressors,  
2 rotating cheek holders  
2 movable tooth hooks and thread guide

con 3 baja lenguas intercambiables,  
2 valvulas giratorias p. las labios,  
2 ganchos graduables

con 3 depressori intercambiabili,  
2 valve laterali rotative  
2 uncini a denti mobile e guida dentale



1 24 x 62 mm  
54-317-01

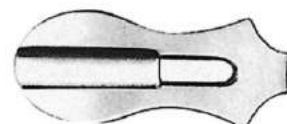

2 28 x 65 mm  
54-317-02

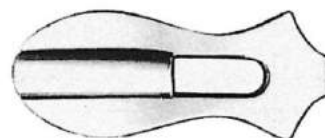

3 31 x 75 mm  
54-317-03





54-320-20  
Silicon Tubing  
tubo de silicon  
tubo in silicone

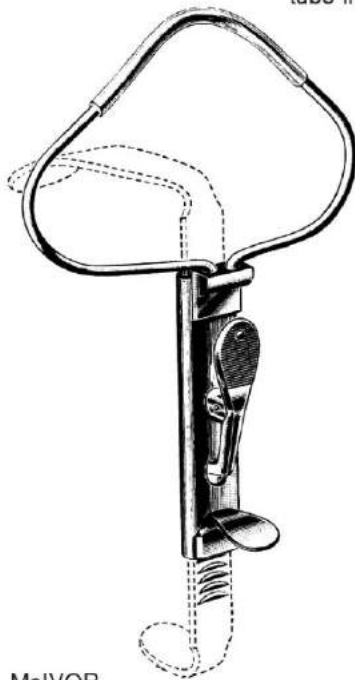

McIVOR  
54-320-00  
Complete

54-320-10

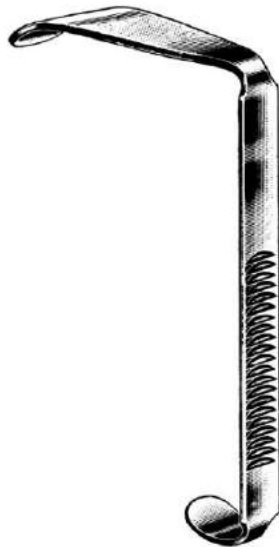

54-320-01  
27 x 95 mm Fig. 1



54-320-02  
22 x 85 mm Fig. 2



54-320-03  
22 x 70 mm Fig. 3



Mouth Gags  
Abre-bocas

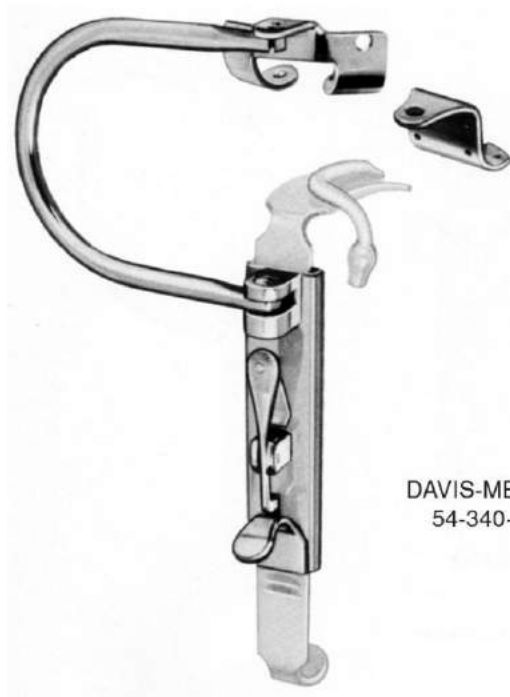

DAVIS-MEYER  
54-340-00





Disimpaction Forceps, Chest Support  
Pinzas para reposiciones, Soporte de pecho



NEGUS  
54-400-01



Left Side  
izquierda  
lato sinistro



Right Side  
derecha  
lato destro

ROWE  
54-501-22 22.5 cm, 9"  
54-501-23 23.5 cm, 9 1/4"  
54-501-24 24.0 cm, 9 1/2"

Infant, bebé, lattante  
Child, niño, bambino  
Adult, adulto

ROWE  
54-503-22 22.5 cm, 9"  
54-503-23 23.5 cm, 9 1/4"  
54-503-24 24.0 cm, 9 1/2"



Retractors for Mouth and Jaw  
Separadores para cirugía plástica



54-605-07  
25 x 7 mm

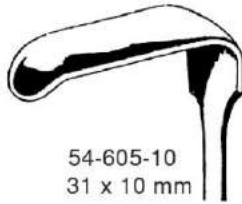

54-605-10  
31 x 10 mm

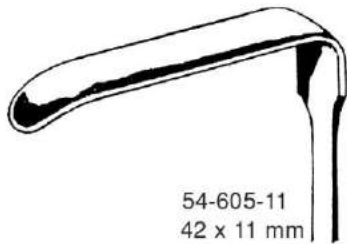

54-605-11  
42 x 11 mm

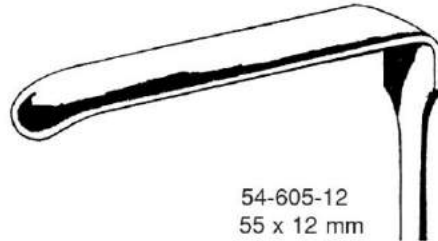

54-605-12  
55 x 12 mm

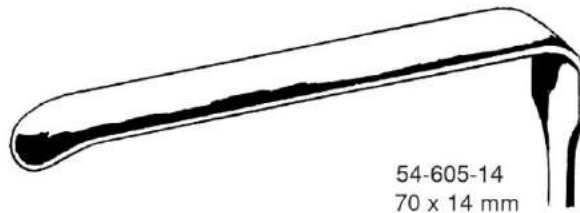

54-605-14  
70 x 14 mm

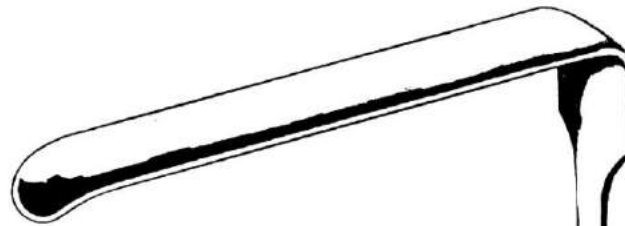

54-605-16  
80 x 16 mm



OBWEGESER  
54-605-07 to 54-605-16  
22 cm, 8 3/4"

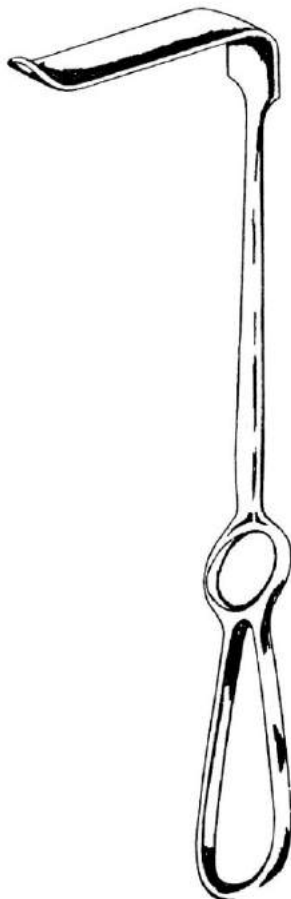

OBWEGESER  
54-610-12 to 54-610-16  
22 cm, 8 3/4"

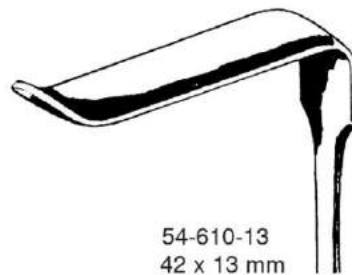

54-610-13  
42 x 13 mm

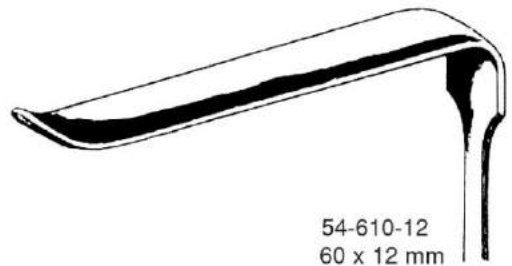

54-610-12  
60 x 12 mm

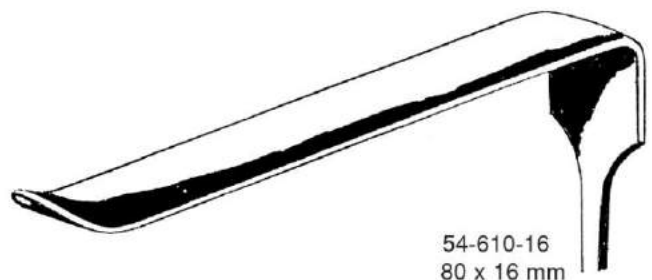

54-610-16  
80 x 16 mm



Retractors for Mouth and Jaw  
Separadores Periostótomos para cirugía plástica

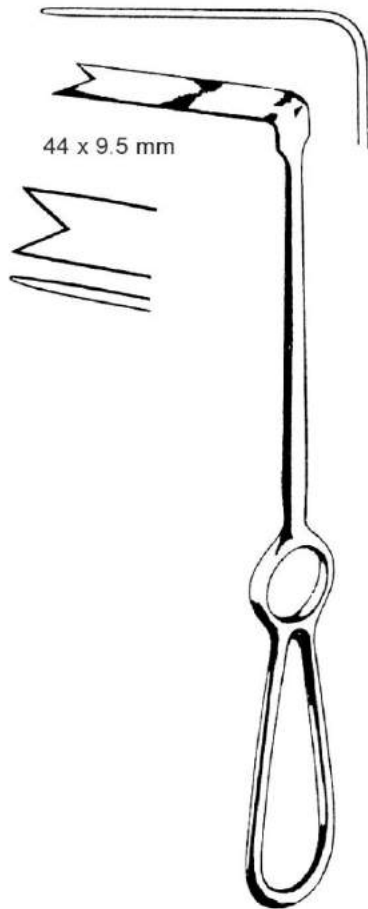

SPINA-NASALIS  
54-613-10  
22 cm, 8 3/4"

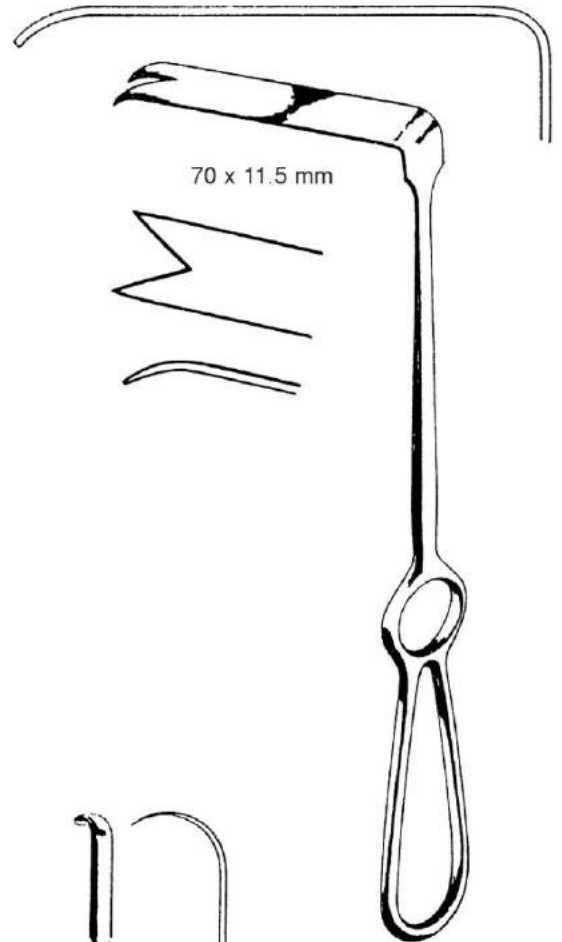

RAMUS  
54-615-12  
22 cm, 8 3/4"

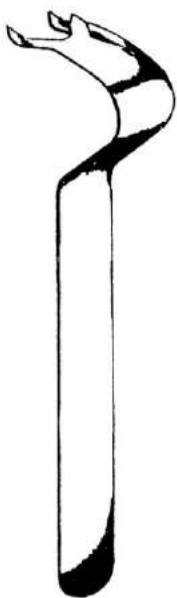

OBWEGESER  
54-620-15  
15.5 cm, 6"

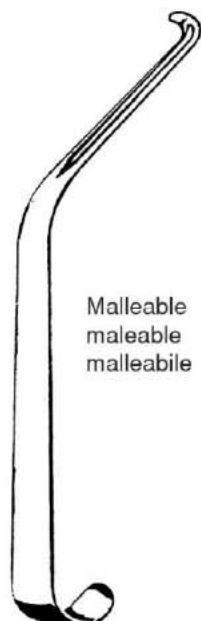

OBWEGESER  
54-623-16  
16 cm, 6 1/4"

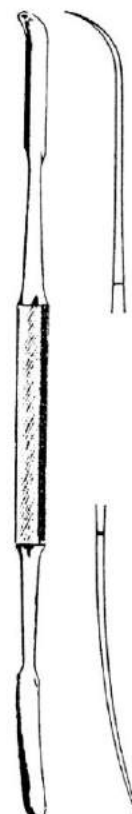

OBWEGESER  
54-627-01  
21 cm, 8 1/4"

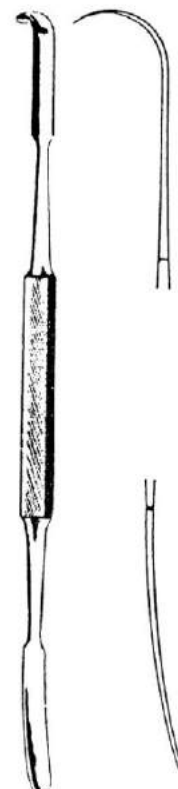

OBWEGESER  
54-630-02  
20.5 cm, 8"

Periosteal Elevators  
Periostótomos



OBWEGESER  
54-635-18  
17.5 cm, 7"



OBWEGESER  
54-640-05 to 54-640-09  
20 cm, 7.9"

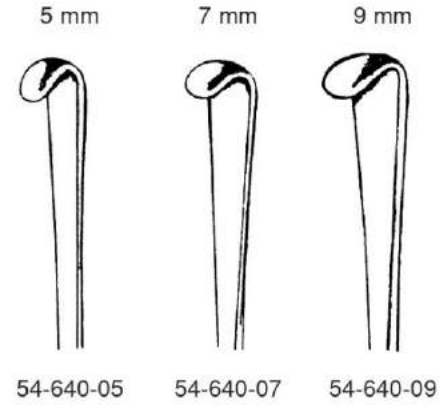

OBWEGESER  
54-650-06 to 54-650-11  
17.5 cm, 7"



54-650-06



54-650-07



54-650-09



54-650-11



## Oral Instruments

### Periostótomos, Agujas, Separadores para cirugía plástica



DINGMAN  
54-660-18  
18 cm, 7"

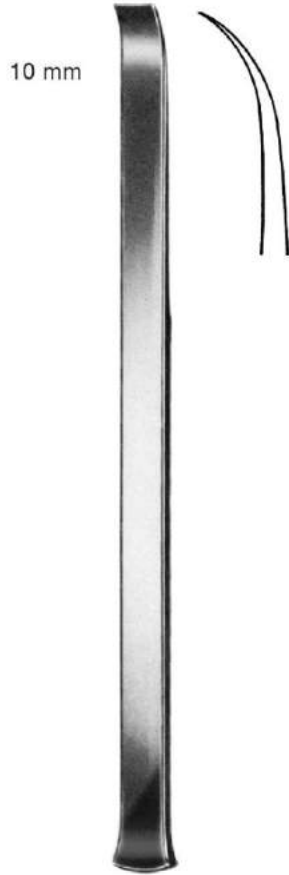

OBWEGESER  
54-665-24  
23.5 cm, 9 1/4"



OBWEGESER  
54-670-23  
23 cm, 9"



OBWEGESER  
54-675-18  
18 cm, 7"

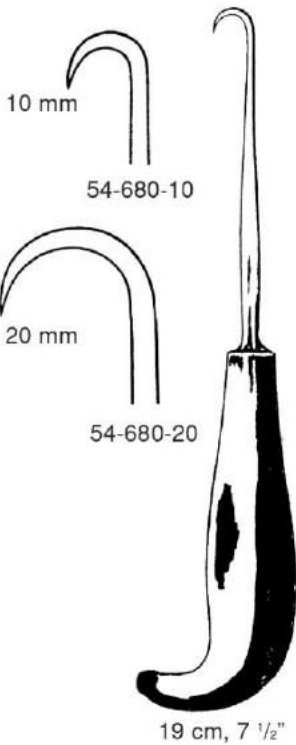

54-680-10

54-680-20

19 cm, 7 1/2"

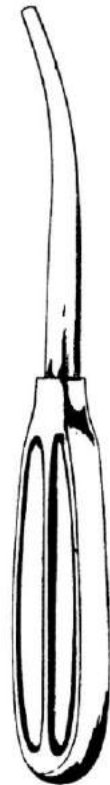

DINGMAN  
54-685-21  
21 cm, 8 1/4"

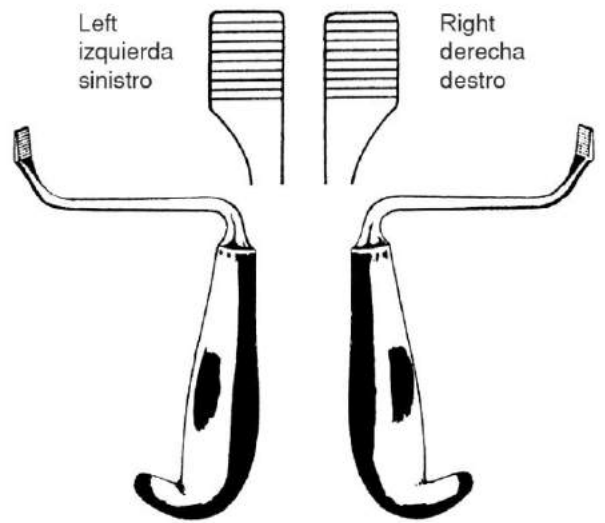

Left  
izquierda  
sinistro

Right  
derecha  
destro

TESSIER  
54-691-15  
15 cm, 6"

TESSIER  
54-692-15  
15 cm, 6"

Chisels  
Cinzel



54-700-01  
21.5 cm, 8 1/2"



54-700-02  
21.5 cm, 8 1/2"





## Tonsil Instruments Elevadores para amígdalas



**LOVE**  
 56-103-18 18 cm, 7"  
 56-103-20 20 cm, 8"  
 56-103-22 22 cm, 8 3/4"

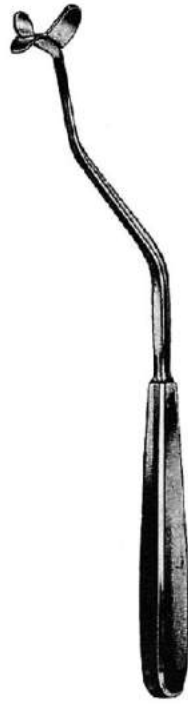

**HOFER**  
 56-109-24  
 24 cm, 9 1/2"



**NAGER**  
 56-111-23  
 23 cm, 9"



**HURD**  
 56-131-22  
 22 cm, 8 1/4"



**LOPEZ-REINKE**  
 56-133-23  
 23 cm, 9"



**YANKAUER**  
 56-134-21  
 21 cm, 8.5"



56-135-01



56-135-02



**HENKE**  
 23 cm, 9"



**CARPENTER**  
 56-139-25  
 25 cm, 10"



**CARPENTER**  
 56-143-24  
 24 cm, 9 1/2"



**LUNIATSCHEK**  
 56-151-19  
 19 cm, 7 1/2"

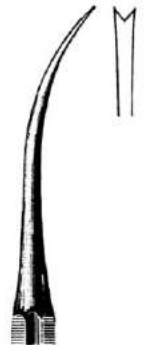



## Tonsil Instruments

Agujas para suturas de amígdalas, Bisturios para amígdalas

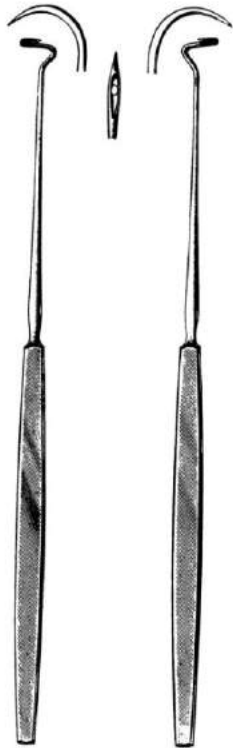

**DUPUY-WEISS**  
56-165-22 56-167-22  
22 cm, 8 3/4"



**CLAUS**  
56-168-23  
23 cm, 9"



**CLAUS-EICKEN**  
56-169-23  
23 cm, 9"



**TRELAT**  
56-170-23  
23 cm, 9"



**NAGER**  
56-170-24  
24 cm, 9 1/2"



**FISHER**  
56-171-22  
22.5 cm, 8.9"



**ABRAHAM**  
56-172-19  
19 cm, 7 1/2"



**ABRAHAM**  
56-173-21  
21 cm, 8 1/4"



**CANFIELD**  
56-174-21  
21 cm, 8 1/4"



**BRUENINGS**  
56-177-23  
23 cm, 9"



**DOUGLAS**  
56-178-21  
21 cm, 8 1/4"



**DOUGLAS**  
56-179-17  
17 cm, 6 3/4"



**Tonsil Seizing Forceps  
Pinzas para coger las amígdalas**

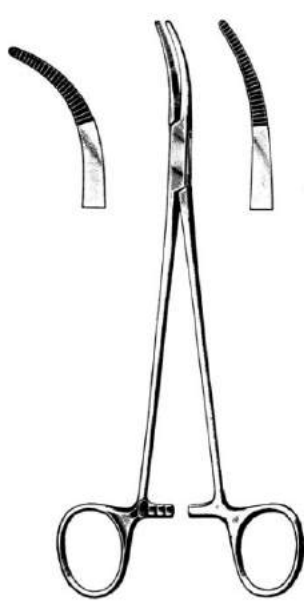

19 cm, 7 1/2"  
SAWTELL    SCHNIDT  
56-181-19    56-183-19

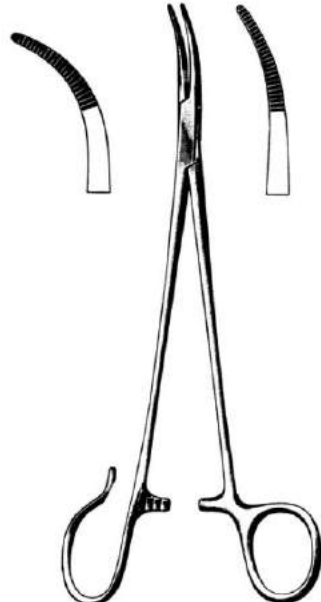

19 cm, 7 1/2"  
SAWTELL    SCHNIDT  
56-185-19    56-187-19



19 cm, 7 1/2"  
NEGUS  
56-191-19    56-193-19

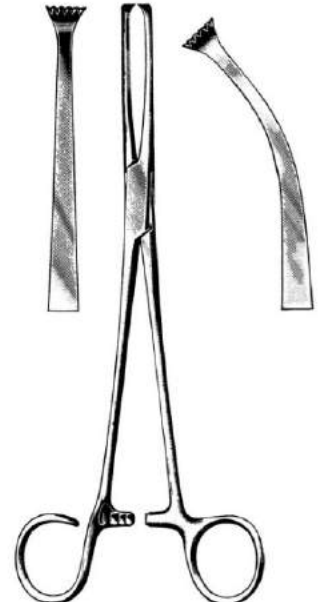

19 cm, 7 1/2"  
COLVER  
56-202-19    56-203-19



WHITE  
56-205-18    18 cm, 7"  
56-205-23    23 cm, 9"



BALLENGER  
56-207-21  
21.5 cm, 8 1/2"



BLOHMKE  
56-209-20  
20 cm, 8"

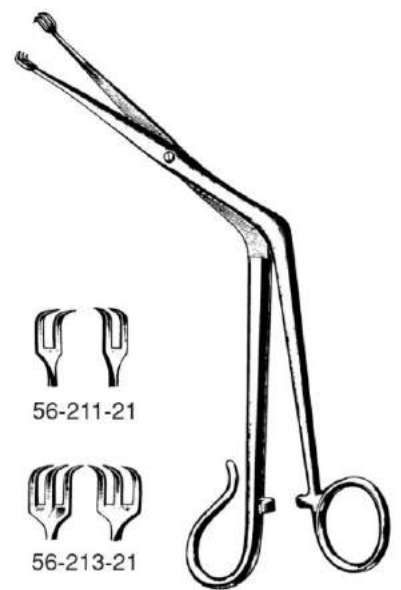

TYDING  
56-211-21    56-213-21  
21 cm, 8 1/4"





Tonsil Forceps, Tonsil Snares

Pinzas, Compresores para amígdalas, Cierra-nudos para amígdalas



ABRAHAM  
56-210-20  
20 cm, 8"



MARSCHIK  
56-219-22  
22 cm, 8 3/4"



EVES  
56-250-28  
28 cm, 11"



EVES  
56-252-28  
28 cm, 11"



BRUENINGS  
56-256-28  
28 cm, 11"

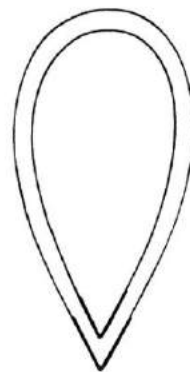

56-257-40 40 mm  
56-257-50 50 mm  
Pkg of 100 each



56-259-03 0.3 mm  
56-259-04 0.4 mm  
56-259-05 0.5 mm  
Pkg of 12 each

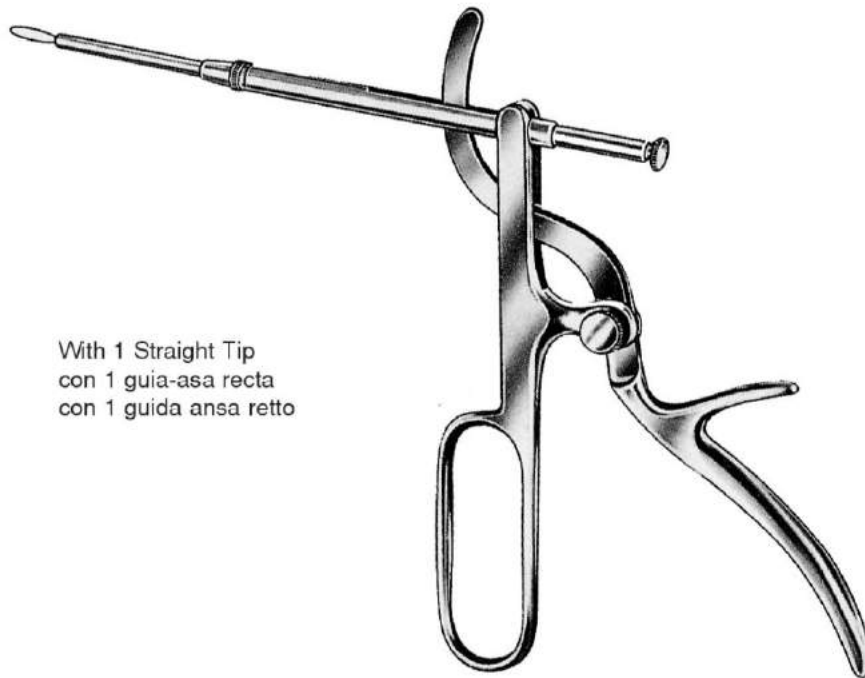

With 1 Straight Tip  
con 1 guía-asa recta  
con 1 guida ansa retto

TYDING  
56-260-00



Tonsil Snare, Syringes, Cannula  
Amigdalótomos, Jeringas, Septum aguja

Blade Only  
hoja sola  
lame solo

56-270-01

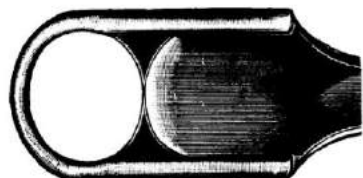

1

56-270-02

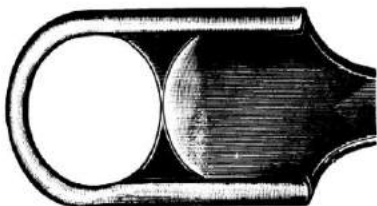

2

56-270-03

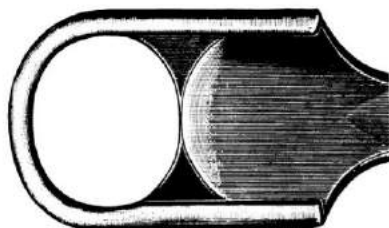

3

Handle Only 56-270-04  
mango para  
manipolo solo per

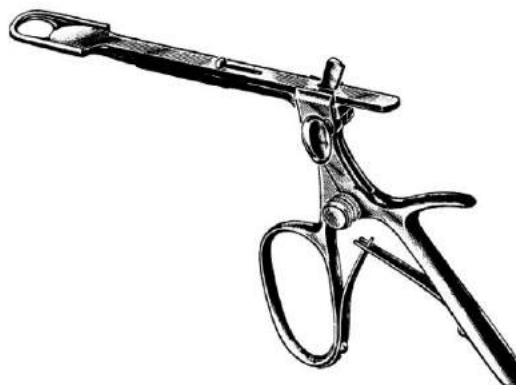

SLUDER-BALLENGER  
56-270-00  
With 3 Blades  
con 3 hojas  
con 3 lame

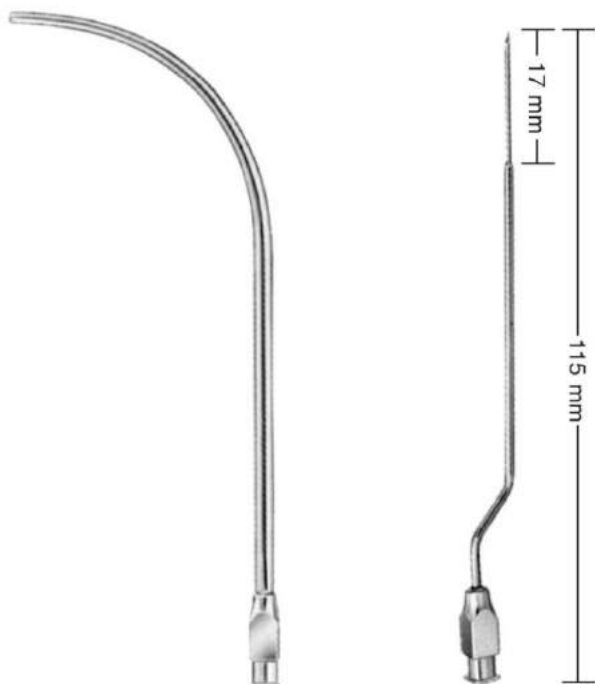

56-291-00  
2.5 mm Ø

56-293-00  
0.8 mm Ø

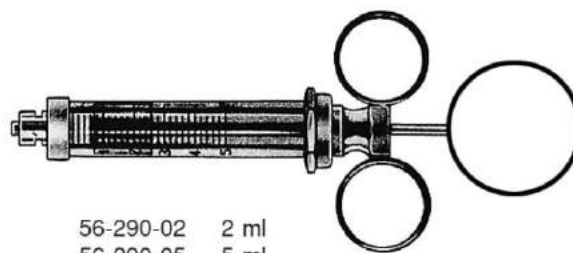

56-290-02 2 ml  
56-290-05 5 ml  
56-290-10 10 ml  
56-290-20 20 ml



56-292-00



56-293-45  
45°



56-293-90  
90°



## Laryngeal Polyp Forceps, Epiglottis Retractor Pinzas para pólipos laríngeos, Depresor para epiglottis

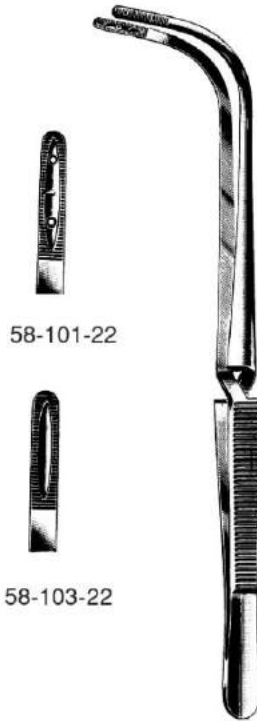

58-101-22

58-103-22

JACKSON  
58-101-22 58-103-22  
22 cm, 8 3/4"

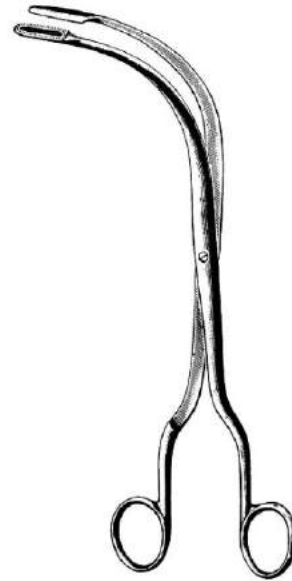

FRAENKEL  
58-111-18  
18 cm, 7"

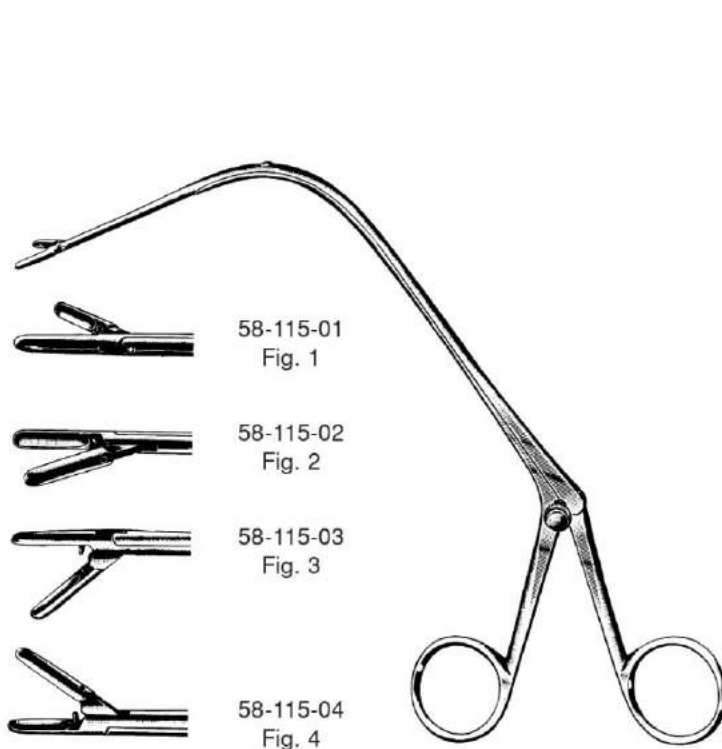

58-115-01  
Fig. 1

58-115-02  
Fig. 2

58-115-03  
Fig. 3

58-115-04  
Fig. 4

JURASZ  
58-115-01 to 58-115-04  
23 cm, 9"



REICHERT  
58-121-24  
24 cm, 9 1/2"



Universal Handles, Interchangeable Tips  
Mangos universales y Tubos de extension



**BRUENINGS**  
58-131-20  
20 cm, 8"



**BRUENINGS**

58-132-20	20 cm, 8"	58-132-50	50 cm, 19.7"
58-132-30	30 cm, 11 3/4"	58-132-60	60 cm, 23 1/2"
58-132-40	40 cm, 15 3/4"		



Universal  
58-130-00



**FRAENKEL**  
58-150-00



**SEIFERT**  
58-152-00



**FRAENKEL**  
58-154-00



**SCHEINMAN**  
58-155-00



**SCHEINMAN**  
58-157-00



**BRUENINGS**  
58-158-02 58-158-03

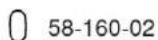

58-160-02



58-160-03



**BRUENINGS**  
58-160-02 58-160-03



**LANGE**  
58-162-00



**KRAUSE**  
58-164-01 58-164-02



**KRAUSE**  
58-166-00



**SCHUMACHER**  
58-170-00



**BARACANI**  
58-175-00



58-177-01



58-177-02



**CORDES**  
58-177-01 58-177-02





## Bronchial Esophageal Forceps, Laryngeal Mirrors, Handles Pinzas para bronco-esofagoscopia, Espejos laringeos, Mangos

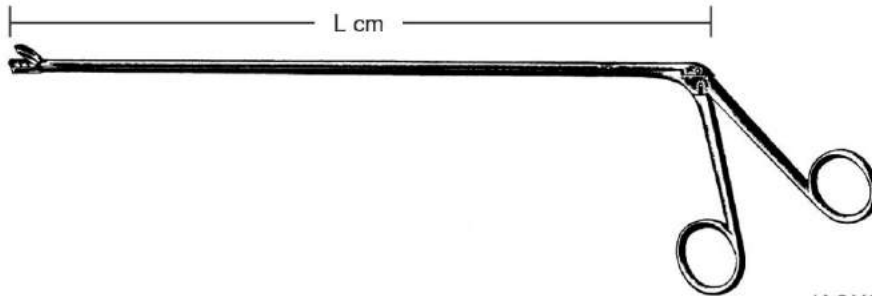

JACKSON-CHEVALIER  
58-230-01 to 58-260-08



cm		Fig. 1	Fig. 2	Fig. 3	Fig. 4	Fig. 5	Fig. 6	Fig. 7	Fig. 8
30	11.8"	58-230-01	58-230-02	58-230-03	58-230-04	58-230-05	58-230-06	58-230-07	58-230-08
40	15.8"	58-240-01	58-240-02	58-240-03	58-240-04	58-240-05	58-240-06	58-240-07	58-240-08
50	19.7"	58-250-01	58-250-02	58-250-03	58-250-04	58-250-05	58-250-06	58-250-07	58-250-08
60	23.6"	58-260-01	58-260-02	58-260-03	58-260-04	58-260-05	58-260-06	58-260-07	58-260-08

Stem Only  
58-270-08 to 58-270-30

Fig.	mm Ø	
58-270-08	00	8 58-272-08
58-270-10	0	10 58-272-10
58-270-12	1	12 58-272-12
58-270-14	2	14 58-272-14
58-270-16	3	16 58-272-16
58-270-18	4	18 58-272-18
58-270-20	5	20 58-272-20
58-270-22	6	22 58-272-22
58-270-24	7	24 58-272-24
58-270-26	8	26 58-272-26
58-270-28	9	28 58-272-28
58-270-30	10	30 58-272-30

Handle Only  
58-272-00

Complete with Handle  
58-272-08 to 58-272-30

58-274-12

58-276-10



## Micro Laryngeal Forceps Pinzas para la micro-cirugía de la laringe

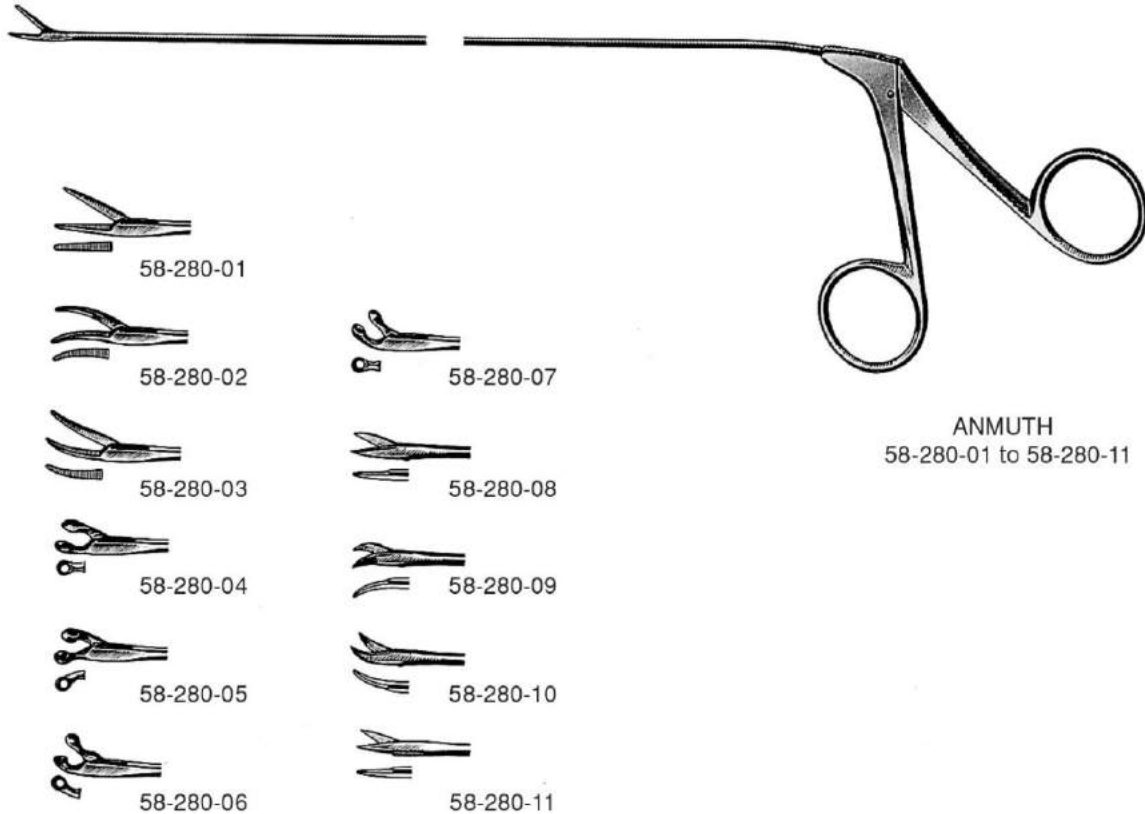

ANMUTH  
58-280-01 to 58-280-11

### Micro Laryngeal Forceps 22 cm, 8 3/4"

- 58-280-01 Grasping Tip, Straight, Serrated, 1.5 x 10 mm
- 58-280-02 Grasping Tip, Curved to Left, Serrated, 1.5 x 8.5 mm
- 58-280-03 Grasping Tip, Curved to Right, Serrated, 1.5 x 8.5 mm
- 58-280-04 Cup Forceps, Straight, 2.5 mm
- 58-280-05 Cup Forceps, Angled to Left, 2.5 mm
- 58-280-06 Cup Forceps, Angled to Right, 2.5 mm
- 58-280-07 Cup Forceps, Angled Up, 2.5 mm
- 58-280-08 Scissors, Straight, Vertical
- 58-280-09 Scissors, Curved to Left
- 58-280-10 Scissors, Curved to Right
- 58-280-11 Scissors, Straight, Horizontal

### Pinza microlaringea 22 cm (8 3/4")

- 58-280-01 boca estriada recta 1,5 x 10 mm
- 58-280-02 boca estriada curva a la izquierda 1,5 x 8,5 mm
- 58-280-03 boca estriada curva a la derecha 1,5 x 8,5 mm
- 58-280-04 boca redonda cortante recta 2,5 mm Ø
- 58-280-05 boca redonda cortante angulada a la izquierda 2,5 mm Ø
- 58-280-06 boca redonda cortante angulada a la derecha 2,5 mm Ø
- 58-280-07 boca redonda cortante angulada hacia arriba 2,5 mm Ø
- 58-280-08 Tijera recta corte vertical
- 58-280-09 Tijera curva a la izquierda
- 58-280-10 Tijera curva a la derecha
- 58-280-11 Tijera recta corte horizontal

### Pinze ad asta tubolare per microchirurgia 22 cm (8 3/4")

- 58-280-01 morsi zigrinati, retti, 1,5 x 10 mm
- 58-280-02 morsi zigrinati, curvi a sinistra, 1,5 x 8,5 mm
- 58-280-03 morsi zigrinati, curvi a destra, 1,5 x 8,5 mm
- 58-280-04 morsi a forma di cucchiaio rotondo retto, 2,5 mm
- 58-280-05 morsi a forma di cucchiaio rotondo angolati a sinistra, 2,5 mm
- 58-280-06 morsi a forma di cucchiaio rotondo angolati a destra, 2,5 mm
- 58-280-07 morsi a forma di cucchiaio rotondo angolati in alto, 2,5 mm
- 58-280-08 forbici, rette, taglio verticale
- 58-280-09 forbici, curve a sinistra
- 58-280-10 forbici, curve a destra
- 58-280-11 forbici, rette, taglio orizzontale



Instruments for Tracheotomy  
Instrumentos tracheotomia

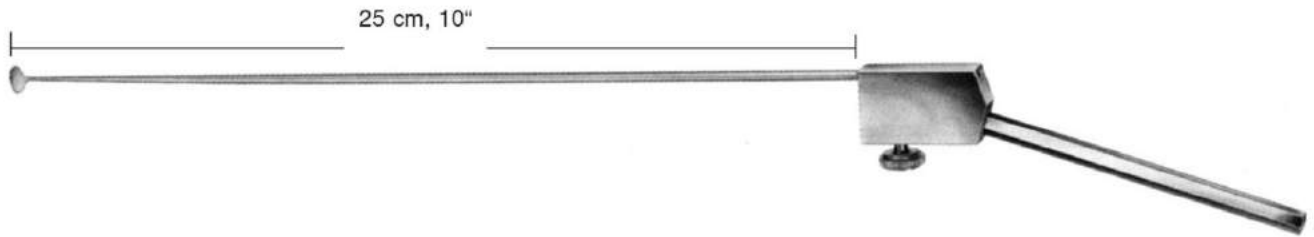

58-290-01  
Knife



58-290-02  
Seperator Oval Vertical



58-290-03  
Seperator Oval Side



58-290-04  
Seperator Angled 45°



58-290-05  
Angled 90° Smooth



58-290-06  
Angled Retrograde 30°



58-290-07

58-290-08  
Handle





## Trachea Dilators, Hooks and Retractors

Trócares traqueales, Dilatadores para la tráquea, Ganchos para traqueotomía

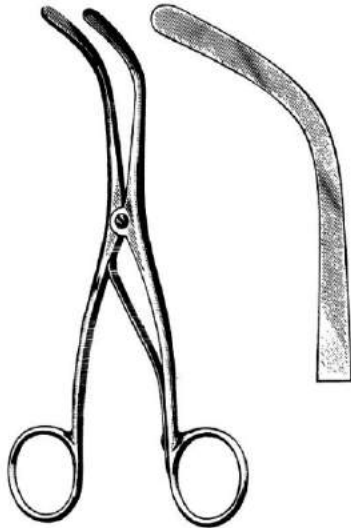

**TROUSSEAU**  
60-111-14 14 cm, 5 1/2"  
**BABY TROUSSEAU**  
60-111-13 13 cm, 5"

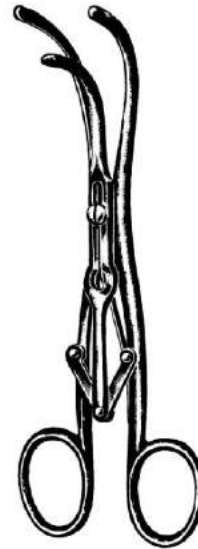

**LABORDE**  
60-113-14  
14 cm, 5 1/2"



**BOSE**  
60-115-07  
7 cm, 2 3/4"



**JACKSON**  
60-116-15  
15 cm, 6"



**JACKSON**  
60-117-17  
17 cm, 6 3/4"



Trachea Hooks, Tube  
Ganchos para traqueotomía, Cánula



**ITERSON**  
60-118-16 60-119-16  
16 cm, 6 1/4"

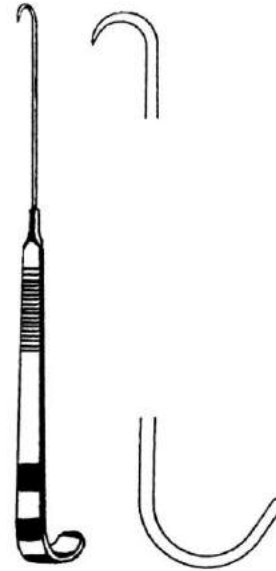

**NEWS**  
60-120-15  
15 cm, 6"

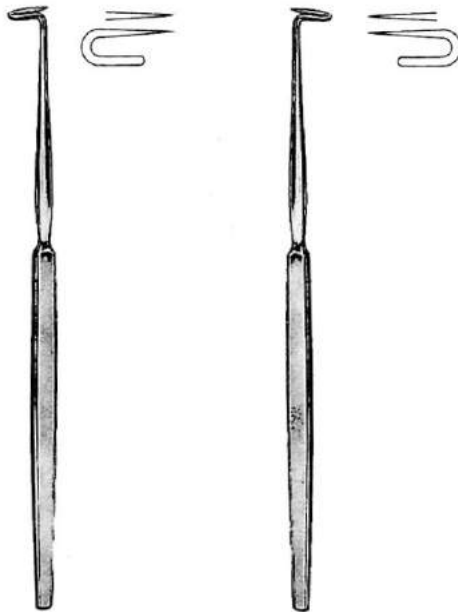

**BOSE**  
60-122-16  
16 cm, 6 1/4"

**BOSE**  
60-124-16  
16 cm, 6 1/4"



**WAGENER-MOSHER**  
60-151-05 5 mm  
60-151-07 7 mm  
60-151-09 9 mm



## Tracheotomy Set Estuche para Traqueotomía

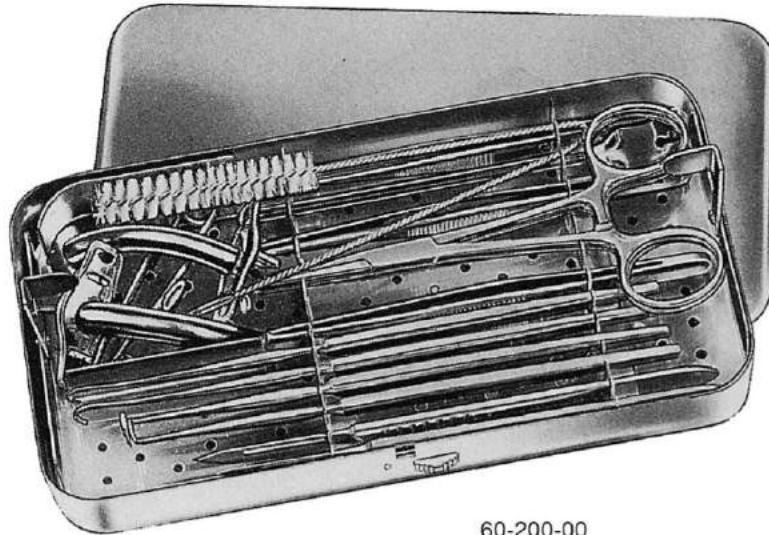

60-200-00

### Tracheotomy Set in Metal Case, consisting of:

- 1 Handle with #20 blade
- 1 Handle with #23 blade
- 1 Thumb Forceps, 13 cm, 5 1/8"
- 1 Tissue Forceps, 13 cm, 5 1/8", 1x2 teeth
- 2 Pean Artery Forceps, 13 cm, 5 1/8"
- 1 Grooved Director, 13 cm, 5 1/8"
- 1 Trachea Dilator
- 1 Iterson Trachea Retractors, blunt
- 1 Bose Trachea Retractor, sharp, left hand side
- 1 ditto, right hand side
- 1 Luer Trachea Tube, Standard, Fig. 3
- 1 ditto, Fig. 4
- 1 Cleaning Brush

### Estuche para Traqueotomía

en estuche de metal, compuesto de:

- 1 Mango con 1 hoja fig. 20
- 1 Mango con 1 hoja fig. 23
- 1 Pinza de disección, 13 cm (5 1/8")
- 1 Pinza de disección, con 1x2 dientes de ratón, 13 cm (5 1/8")
- 2 Pean Pinzas hemostáticas, 13 cm (5 1/8")
- 1 Sonda acanalada, 13 cm (5 1/8")
- 1 Dilatador traqueal
- 2 Iterson separadores traqueales, romos
- 1 Bose separador traqueal, agudo, lado izquierdo
- 1 idem, lado derecho
- 1 Luer Cánula traqueal, modelo standard, Fig. 3
- 1 idem, Fig. 4
- 1 Cepillo de limpieza

### Set per tracheotomia

in scatola in metallo, composto da:

- 1 Manico di bisturi con 1 lama fig. 20
- 1 Manico di bisturi con 1 lama fig. 23
- 1 Pinza per dissezione, cm 13 (5 1/8")
- 1 Pinza per dissezione con denti 1x2, cm 13 (5 1/8")
- 2 Pinze emostatiche Pean, cm 13 (5 1/8")
- 1 Sonda scanalata, cm 13 (5 1/8")
- 1 Dilatatore tracheale
- 2 Uncini tracheali Iterson, smussi
- 1 Uncino tracheale Bose, acuto, lato sinistro
- 1 detto, lato destro
- 1 Cannula tracheale Luer standard, Fig. 3
- 1 detta, Fig. 4
- 1 Spazzolino per pulire



## Trachea Tubes, Thyroid Instruments Cánulas traqueales, Separador para la glándula tiroidea,

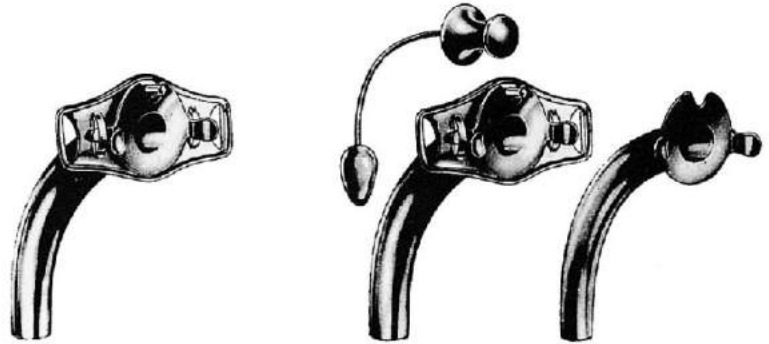

LUER

JACKSON

Fig.	Ø mm	Length of Outer Tube Largo de la cánula exterior Lunghezza del tubo esterno
0	4	45
1	5	50
2	6	55
3	7	60
4	8	65
5	9	70
6	10	75
7	11	80
8	12	85
9	13	90

Silver  
plata neuva  
argentone  
45-90 mm  
60-220-04  
60-220-05  
60-220-06  
60-220-07  
60-220-08  
60-220-09  
60-220-10  
60-220-11  
60-220-12  
60-220-13

Silver  
plata neuva  
argentone  
45-90 mm  
60-240-04  
60-240-05  
60-240-06  
60-240-07  
60-240-08  
60-240-09  
60-240-10  
60-240-11  
60-240-12  
60-240-13

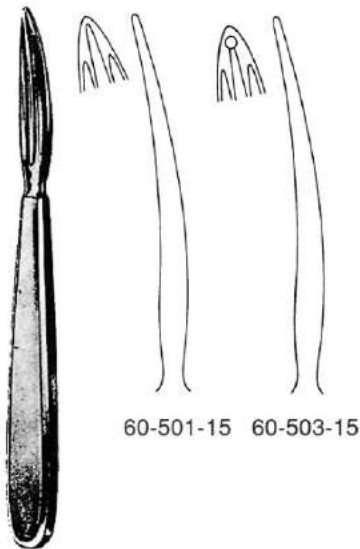

60-501-15 60-503-15



SCHOENBORN  
60-511-21  
21 cm, 8 1/4"



LAHEY  
60-520-15 15 cm, 6"  
60-520-20 20 cm, 8"

MASTIN  
60-523-17  
17 cm, 6 3/4"

KOCHER  
60-501-15 60-503-15  
15 cm, 6"



Rib Shears, Sternum Knife  
Costótomos

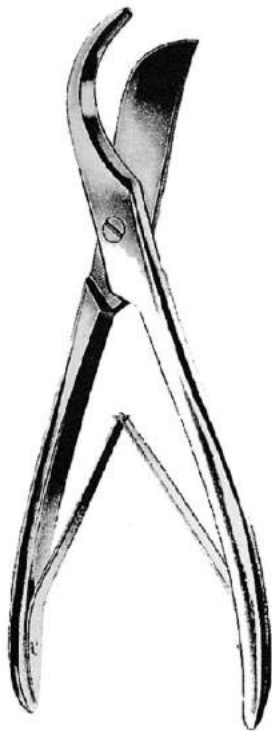

ROSS  
62-102-23  
23 cm, 9"

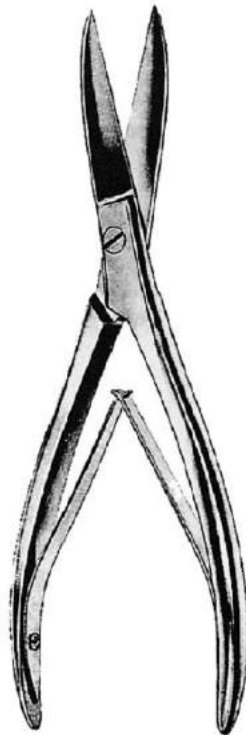

LAWRENCE  
62-105-22  
22 cm, 8 3/4"



LEBSCHÉ  
38-678-24 24.5 cm, 9 3/4"

With Eccentric  
Sliding Blade



GLUCK  
62-107-22  
22 cm, 8 3/4"



STILLE  
62-111-21  
21 cm, 8 1/4"



CORYLLOS  
62-125-35  
35 cm, 13 3/4"



CORYLLOS  
62-123-35  
35 cm, 13 3/4"





Rib Shears, Sternum Cutters  
Costótomos, Tijeras de esternón

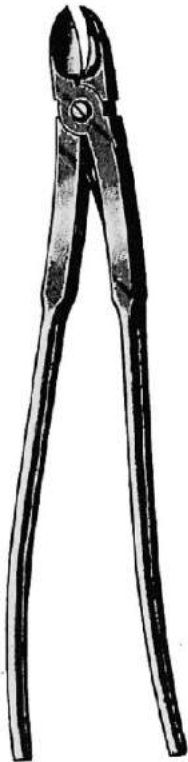

BETHUNE  
62-126-34  
34 cm, 13.4"



SAUERBRUCH  
62-131-26

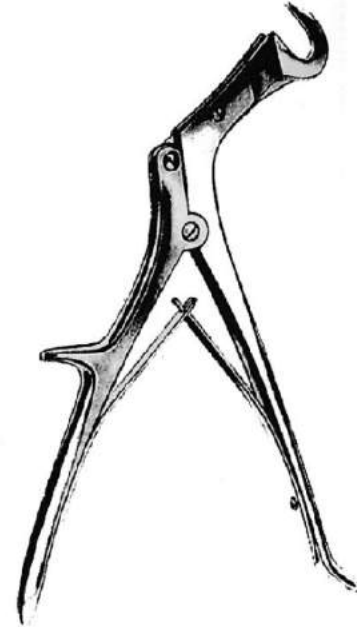

STILLE-GIERTZ  
62-137-27  
27 cm, 10 1/2"



SCHUMACHER  
62-138-21  
21 cm, 8 1/4"



SAUERBRUCH-FREY  
62-141-36  
36 cm, 14.2"

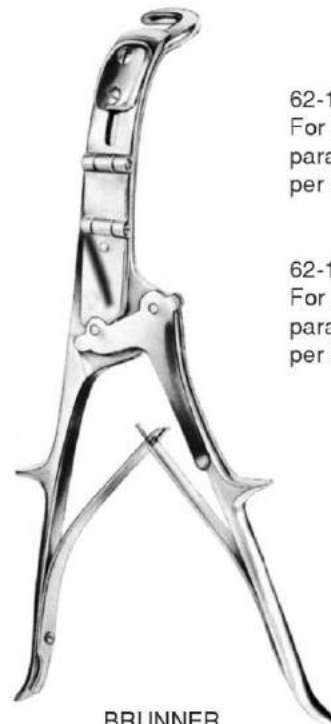

BRUNNER  
62-146-28 - 62-147-28  
28 cm, 11"

62-146-28  
For Right Hand  
para la mano derecha  
per la mano destra

62-147-28  
For Left Hand  
para la mano izquierda  
per la mano sinistra



## Rib Spreaders Separadores costales

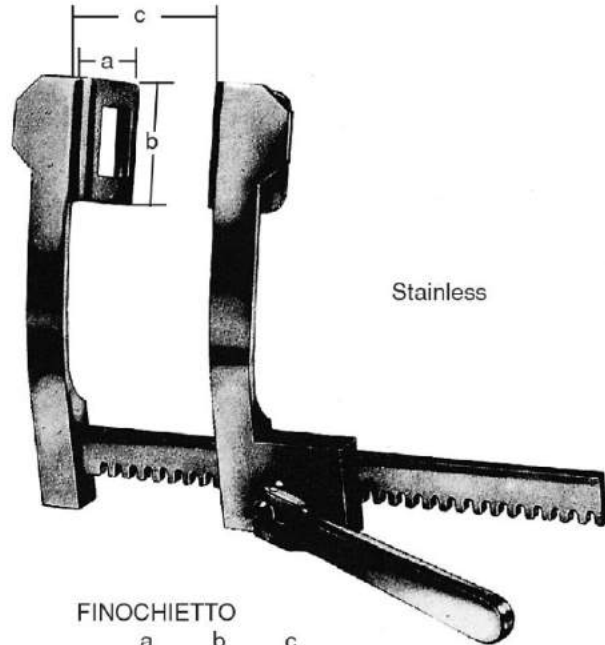

Stainless

FINOCHIETTO			
	a	b	c
	mm	mm	mm
62-210-16	38	44	160
62-210-20	52	62	200
62-210-25	65	85	250

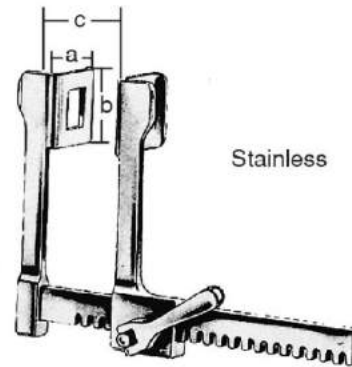

Stainless

BABY-FINOCHIETTO			
	a	b	c
	mm	mm	mm
62-214-75	18	20	75

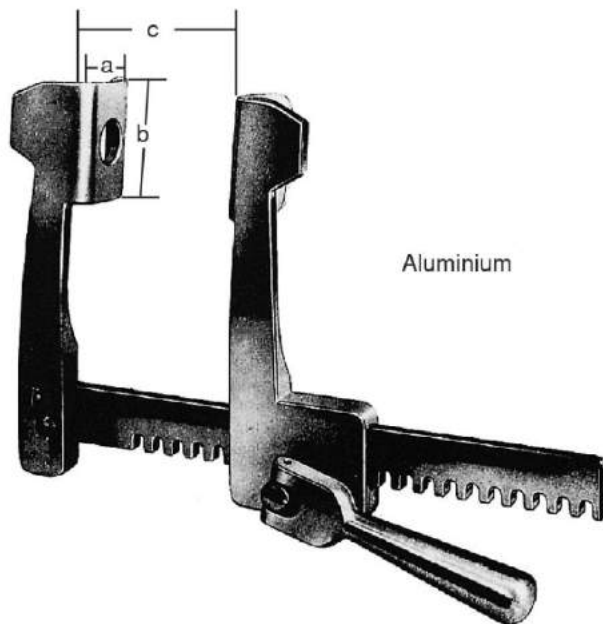

Aluminium

FINOCHIETTO			
	a	b	c
	mm	mm	mm
62-230-13	38	44	135
62-230-17	52	62	175
62-230-18	85	65	175

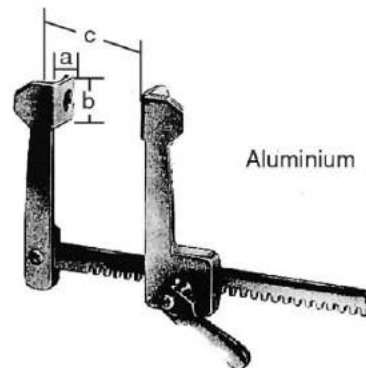

Aluminium

BABY-FINOCHIETTO			
	a	b	c
	mm	mm	mm
62-234-75	15	15	75



Rib Spreaders  
Separadores costales

**BURFORD-FINOCHIETTO**

	a	b	c
	mm	mm	mm
62-236-20	65	62	200
	47	62	
62-236-25	65	62	250
	47	62	
62-236-30	65	62	300
	47	52	



Stainless

Adult  
para adultos  
per adulti

**BURFORD-FINOCHIETTO**

	a	b	c
	mm	mm	mm
62-242-20	47	62	200
	65	62	
62-242-25	47	62	250
	65	62	
62-242-30	47	62	300
	65	62	



Aluminium

Child  
para niños  
per bambini

**BURFORD-FINOCHIETTO**

	a	b	c
	mm	mm	mm
62-244-13	34	42	135
	48	42	



Aluminium

## Rib Spreaders Separadores costales

**FINOCHIETTO**

	a	b	c
	mm	mm	mm
62-245-13	14	14	120

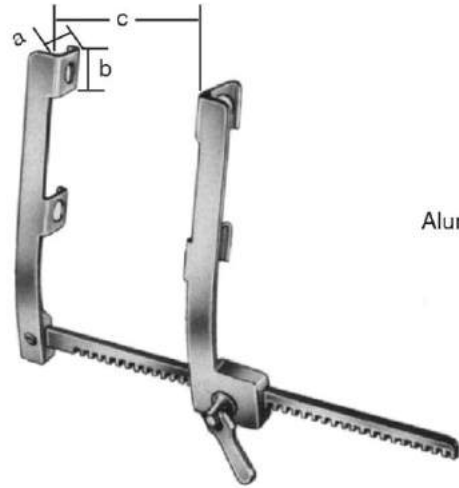

Aluminium

**MORSE-FAVALORO**

	a	b	c
	mm	mm	mm
62-246-16	17	22	160



Stainless

**MORSE**

	a	b	c
	mm	mm	mm
62-246-21	19	27	210



Stainless

Rib Spreaders  
Separadores costales

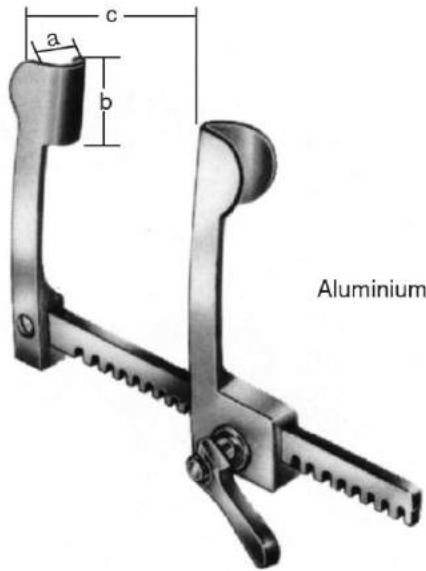

Aluminium

COOLEY NEONATAL

	a	b	c
	mm	mm	mm
62-247-95	12	16	95

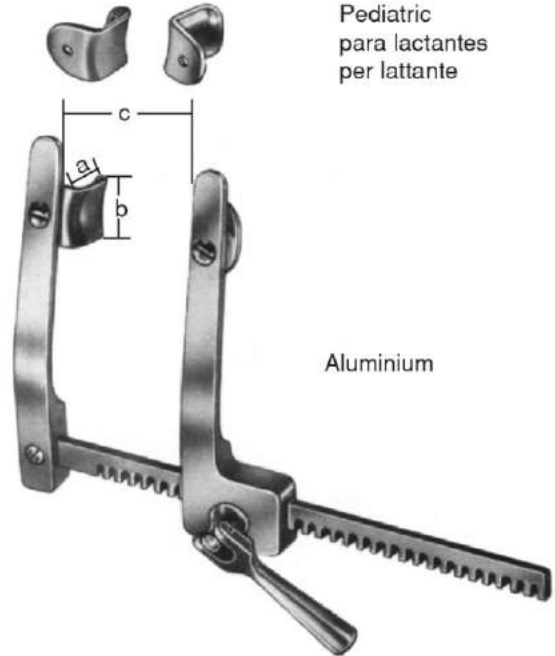

Pediatric  
para lactantes  
per lattante

Aluminium

COOLEY

	a	b	c
	mm	mm	mm
62-249-01	10	14	90

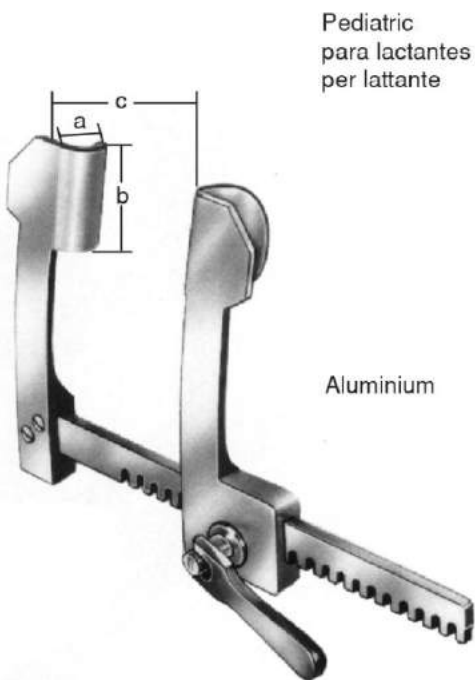

Pediatric  
para lactantes  
per lattante

Aluminium

COOLEY

	a	b	c
	mm	mm	mm
62-248-14	15	30	140

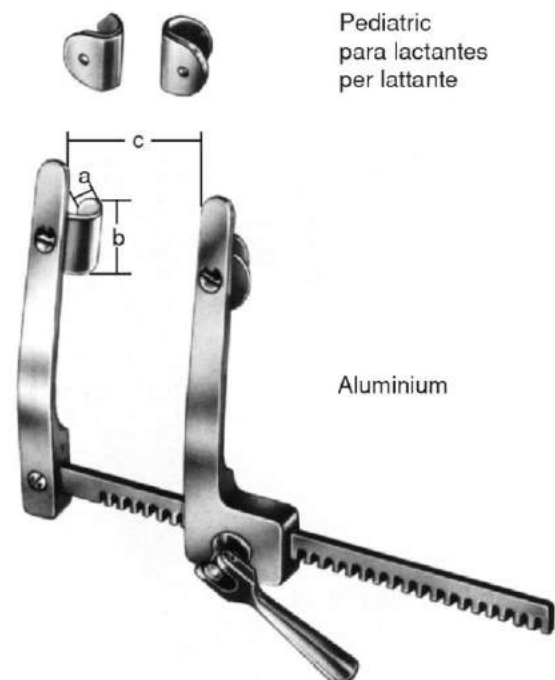

Pediatric  
para lactantes  
per lattante

Aluminium

COOLEY

	a	b	c
	mm	mm	mm
62-249-02	10	14	90



## Rib Spreaders Separadores costales

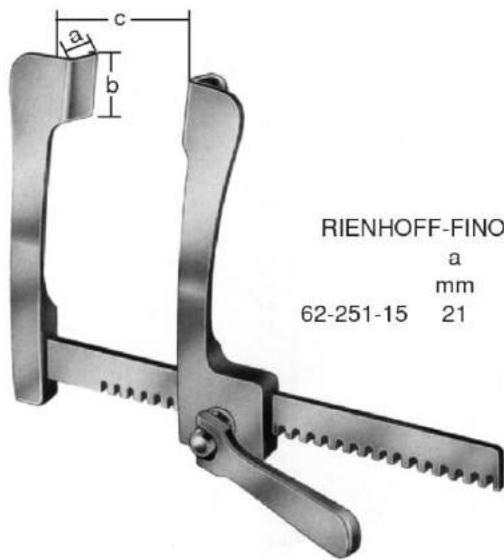

RIENHOFF-FINOCHIETTO

	a	b	c
	mm	mm	mm
62-251-15	21	26	150

Stainless



DE-BOER

	a	b	c
	mm	mm	mm
62-252-19	27	100	190

Stainless



**Rib Spreaders  
Separadores costales**

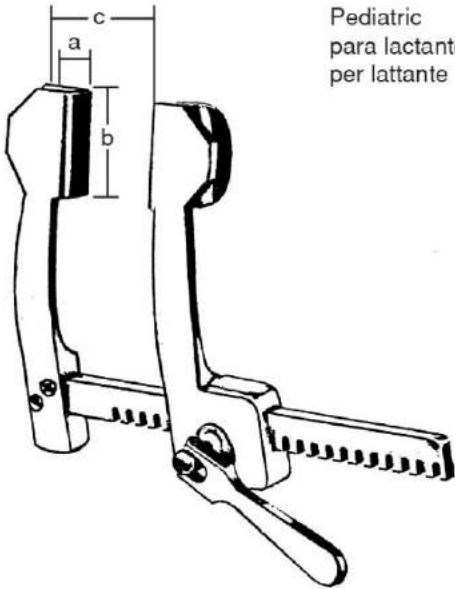

Pediatric  
para lactantes  
per lattante

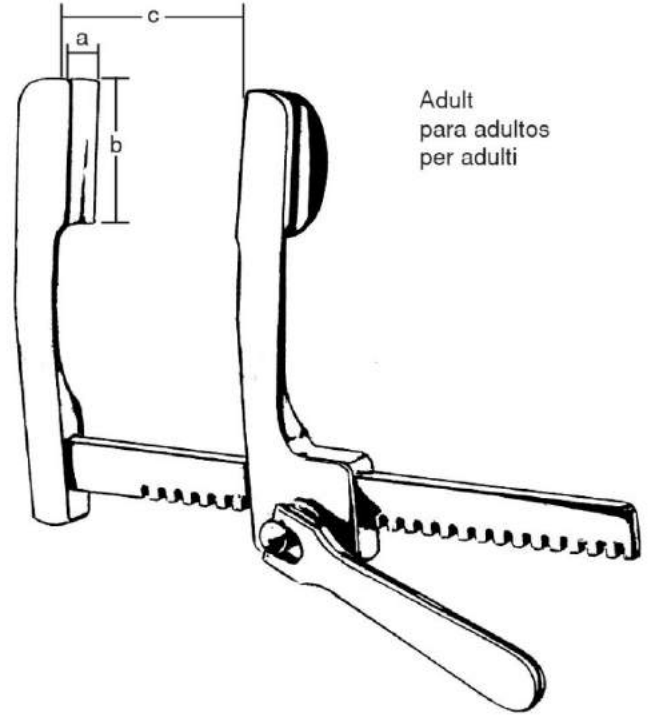

Adult  
para adultos  
per adulti

**COOLEY**

	a	b	c	
	mm	mm	mm	
62-260-02	16	30	105	
62-260-03	21	44	150	Stainless

**COOLEY**

	a	b	c	
	mm	mm	mm	
62-260-04	37	49	200	Stainless

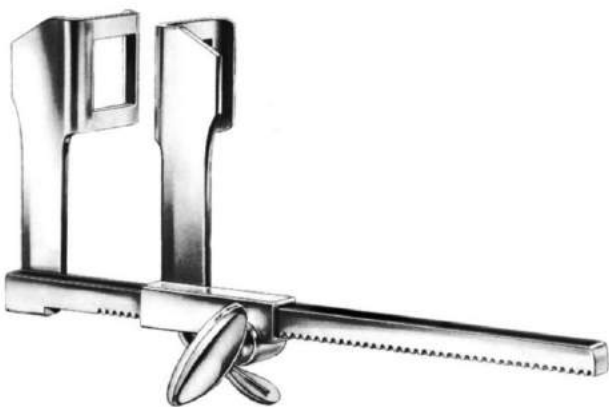

**HAIGHT**

	a	b	c	h	
	mm	mm	mm	mm	
62-260-06	30	30	90	65	
62-260-09	30	30	90	90	Stainless



**TUFFIER**

	a	b	c	
	mm	mm	mm	
62-264-16	50	45	165	Stainless

Laminectomy Retractor  
Separadores para laminectomía

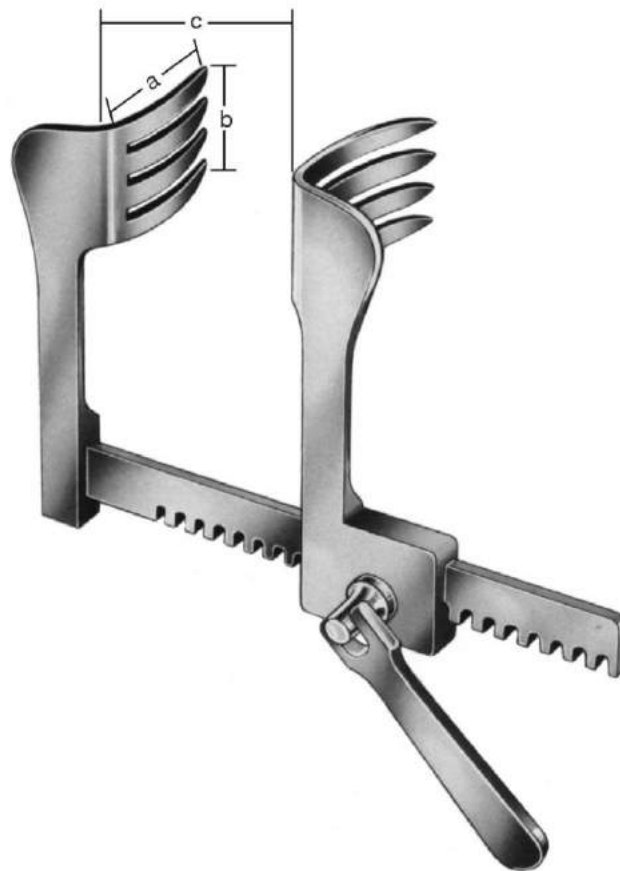

	CHERRY		
	a	b	c
	mm	mm	mm
62-266-13	44	70	135





## Thoracic Retractor, Rib Contractors, Lung Spatulas Separador torácico, Aproximadores para costillas, Espátulas pulmonares



MERCEDES SL Complete  
62-270-00

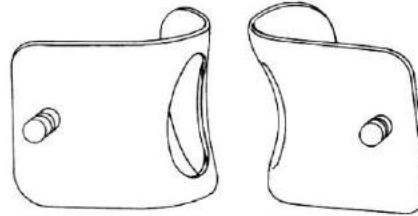

62-270-75  
75 x 75 mm

62-270-80  
Retractor Only  
Separador solo  
Divaricatore solo

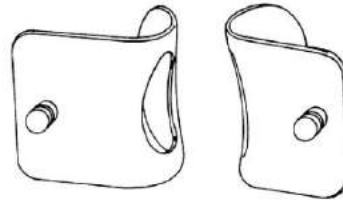

62-270-65  
42 x 65 mm

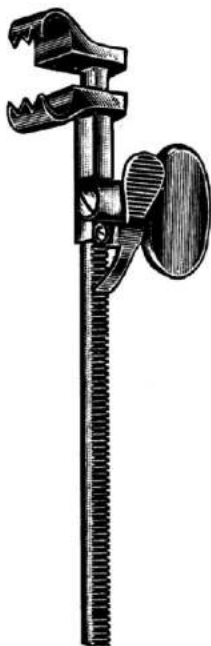

BABY-BAILEY  
62-283-14  
14 cm, 5 1/2"

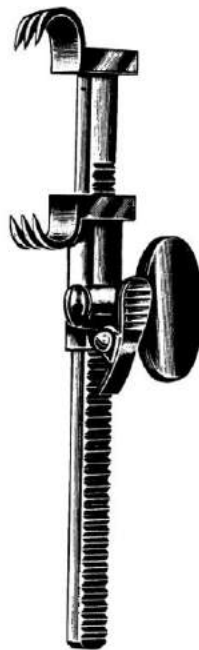

BAILEY  
62-284-16  
16 cm, 6 1/4"



BAILEY-GIBBON  
62-286-16  
16 cm, 6 1/4"



ALLISON  
62-289-32  
32 cm, 12 3/4"



Lung Grasping Forceps, Bronchus Forceps  
 Pinzas para coger el pulmón, Pinzas clamps bronquiales



LOVELACE  
 62-290-20  
 20 cm, 8"

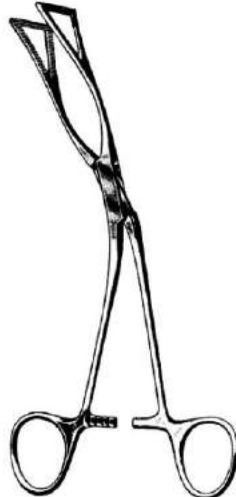

LOVELACE  
 62-291-20  
 20 cm, 8"



HARRINGTON  
 62-301-30  
 30.5 cm, 12"

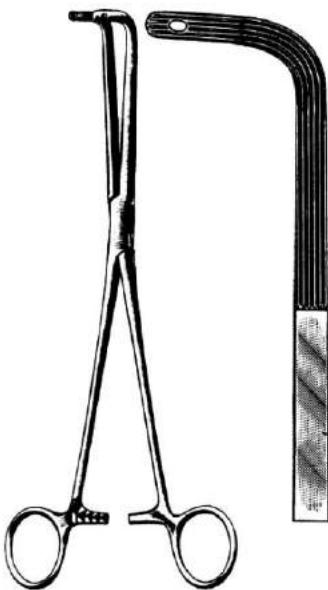

FINOCCHIETTO  
 62-307-24  
 24 cm, 9 1/2"

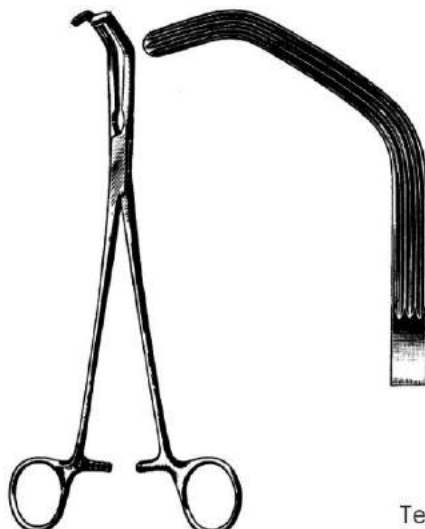

PRICE-THOMAS  
 62-309-22  
 22 cm, 8 3/4"

Teeth Left  
 diente izquierda  
 denti sinistro  
 62-311-22



PRICE-THOMAS  
 22 cm, 8 3/4"

Right  
 derecha  
 destro  
 62-313-22



Thoracic Clamps  
Pinzas-clamps para vasos

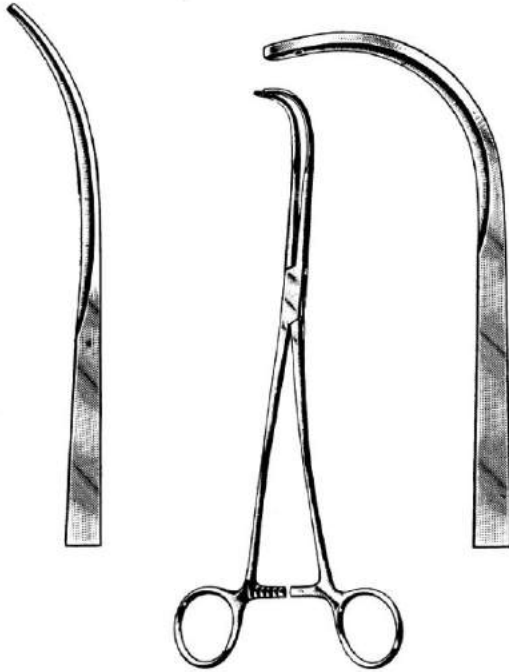

62-321-23

SEMB  
23 cm, 9"

62-323-23

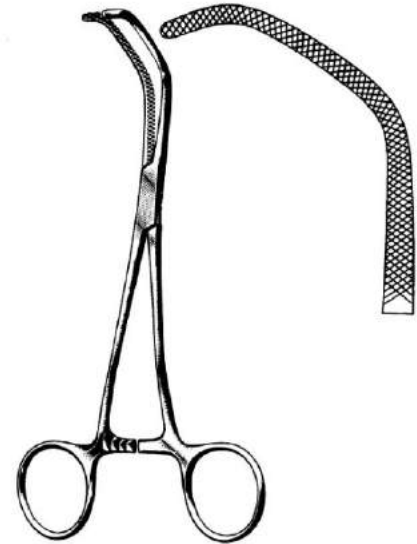

SATINSKY  
62-325-15  
15 cm, 6"

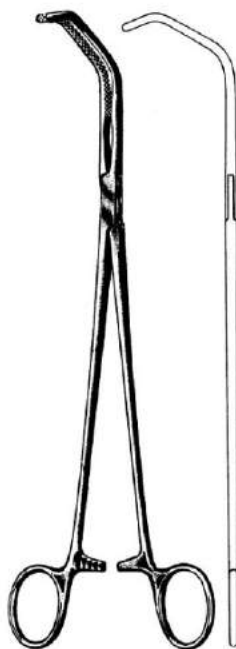

SATINSKY  
62-327-26 62-329-26  
26 cm, 10 1/4"

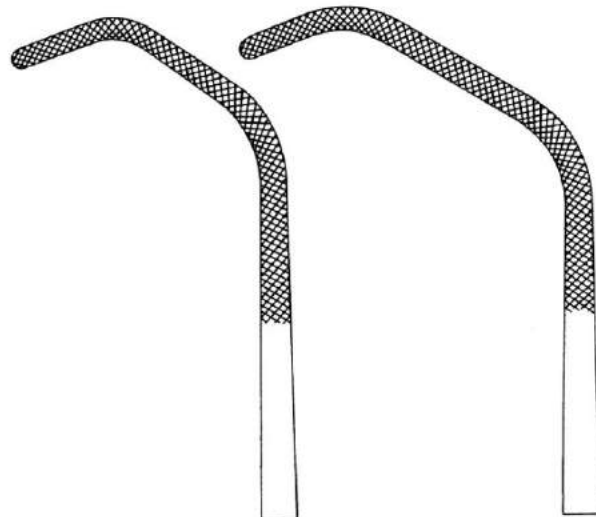
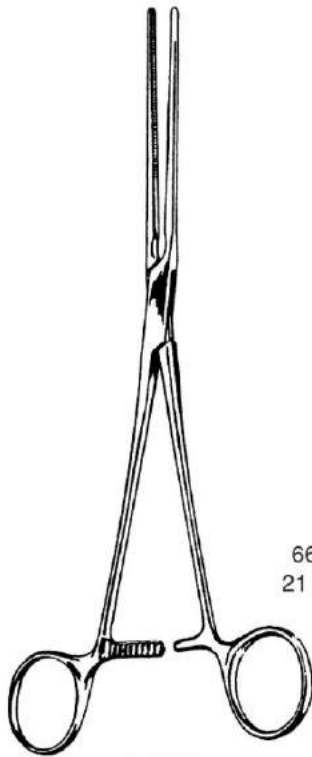

Fig. 1 62-327-26

Fig. 2 62-329-26



Atraumatic Coarctation Clamps  
Pinzas clamps para coartación



POTTS  
66-000-21 66-000-22



66-000-21  
21 cm, 8 1/4"



66-000-22  
22 cm, 8 3/4"

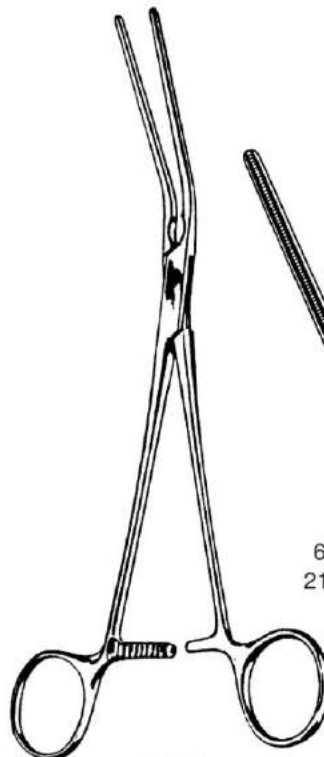

POTTS  
66-001-21 66-001-22



66-001-21  
21 cm, 8 1/4"



66-001-22  
22 cm, 8 3/4"

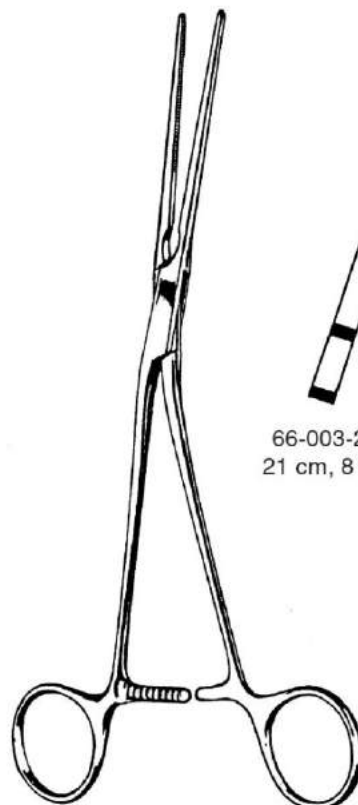

POTTS  
66-003-21 66-003-22



66-003-21  
21 cm, 8 1/4"



66-003-22  
22 cm, 8 3/4"





## Atraumatic Anastomosis Clamps

Pinzas clamps para anastomosis, Pinzas para preparaciones y ligaduras

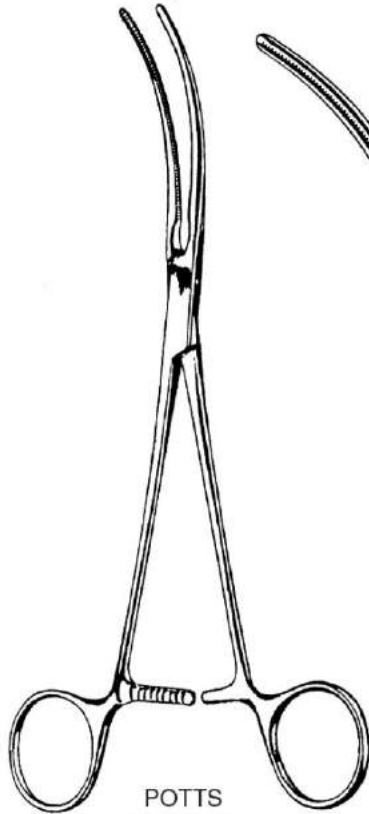

POTTS  
66-005-22  
22 cm, 8 3/4"

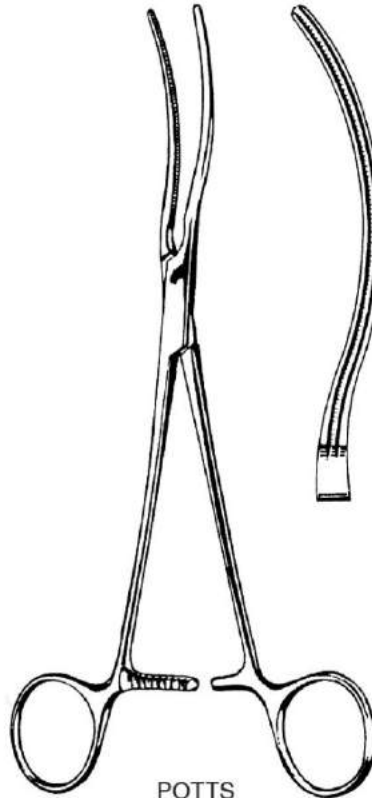

POTTS  
66-007-22  
22 cm, 8 3/4"

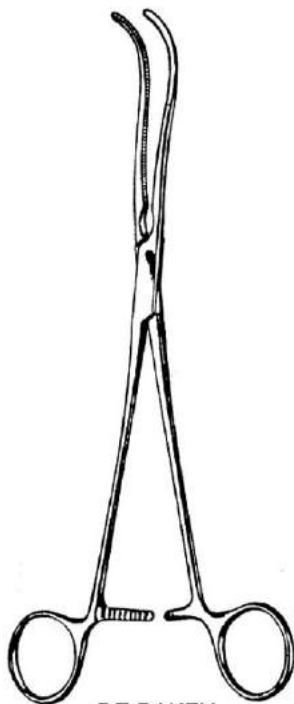

DE BAKEY  
66-008-19 66-008-23



66-008-19  
19 cm, 7 1/2"



66-008-23  
23 cm, 9"



Atraumatic Peripheral Vascular Clamps  
Pinzas-clamps para vasos periféricos

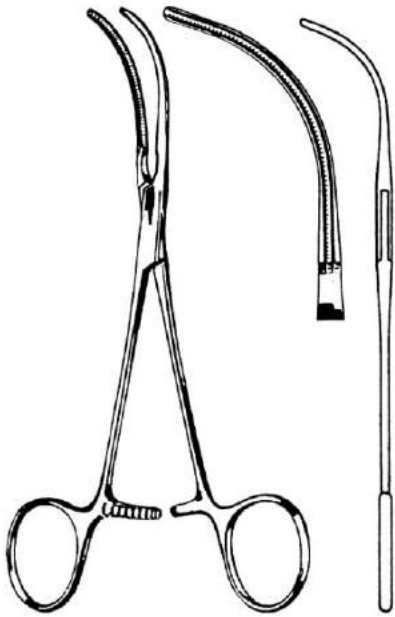

DE BAKEY  
66-009-16  
16 cm, 6 1/4"

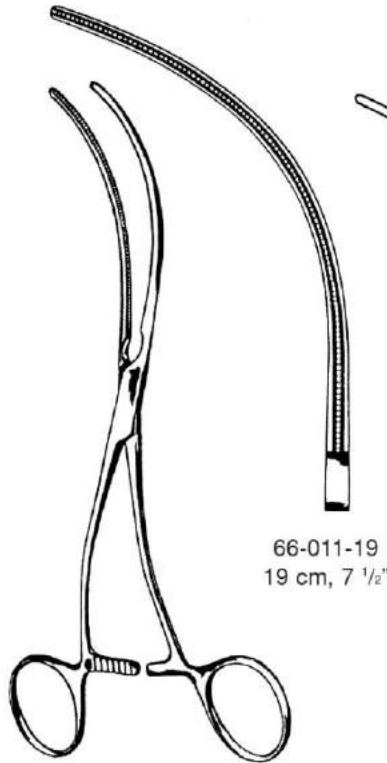

66-011-19  
19 cm, 7 1/2"

DE BAKEY  
66-011-19 66-011-20

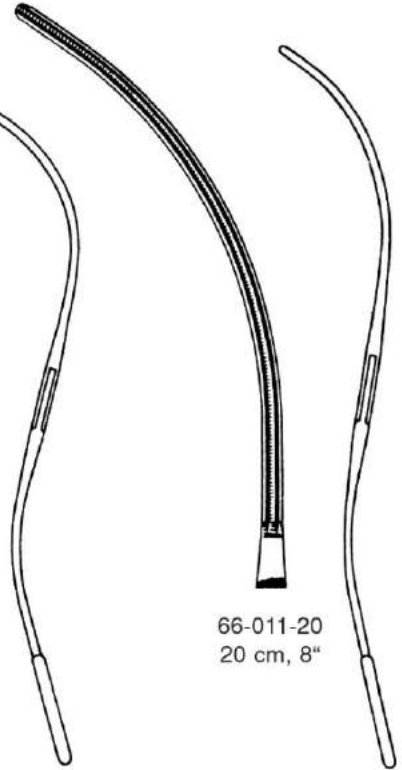

66-011-20  
20 cm, 8"

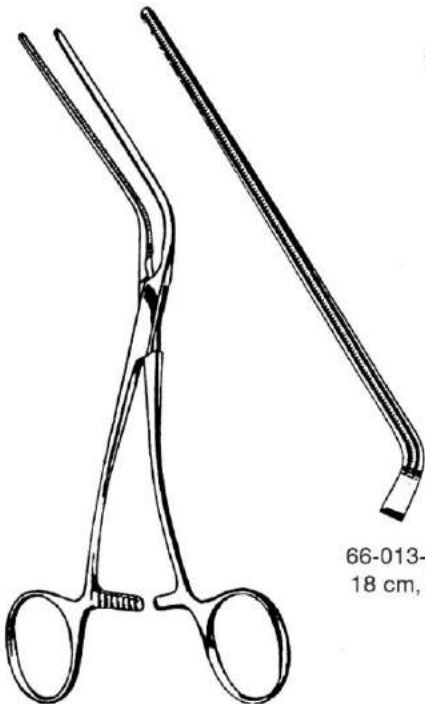

66-013-18  
18 cm, 7"

LELAND-JONES  
66-013-18 to 66-013-20

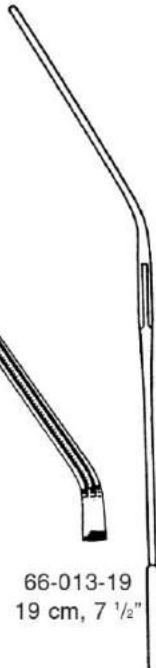

66-013-19  
19 cm, 7 1/2"

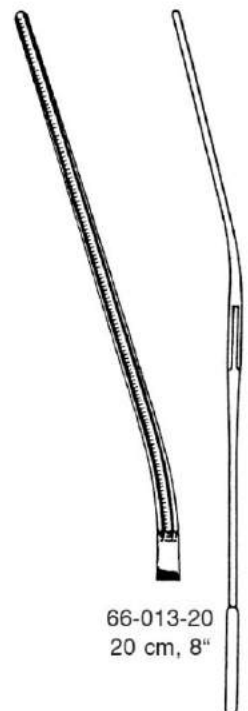

66-013-20  
20 cm, 8"



Atraumatic Cardiovascular Forceps, Renal Artery Clamp  
Atrauma Pinzas-clamps cardiovasculares, Pinza-clamp para arteria renal

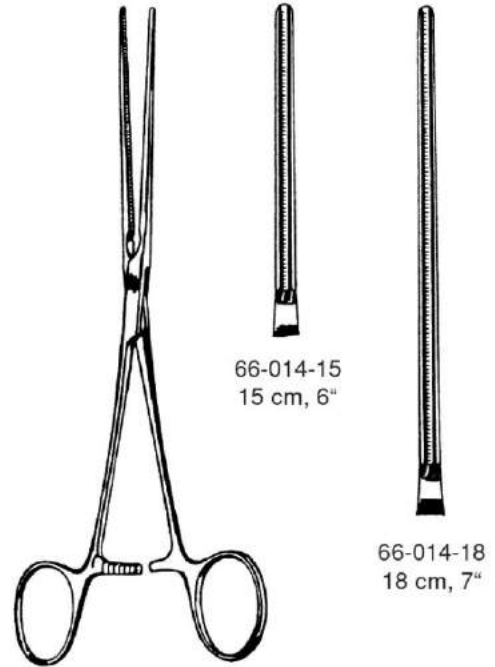

**BAINBRIDGE**  
66-014-15 66-014-18

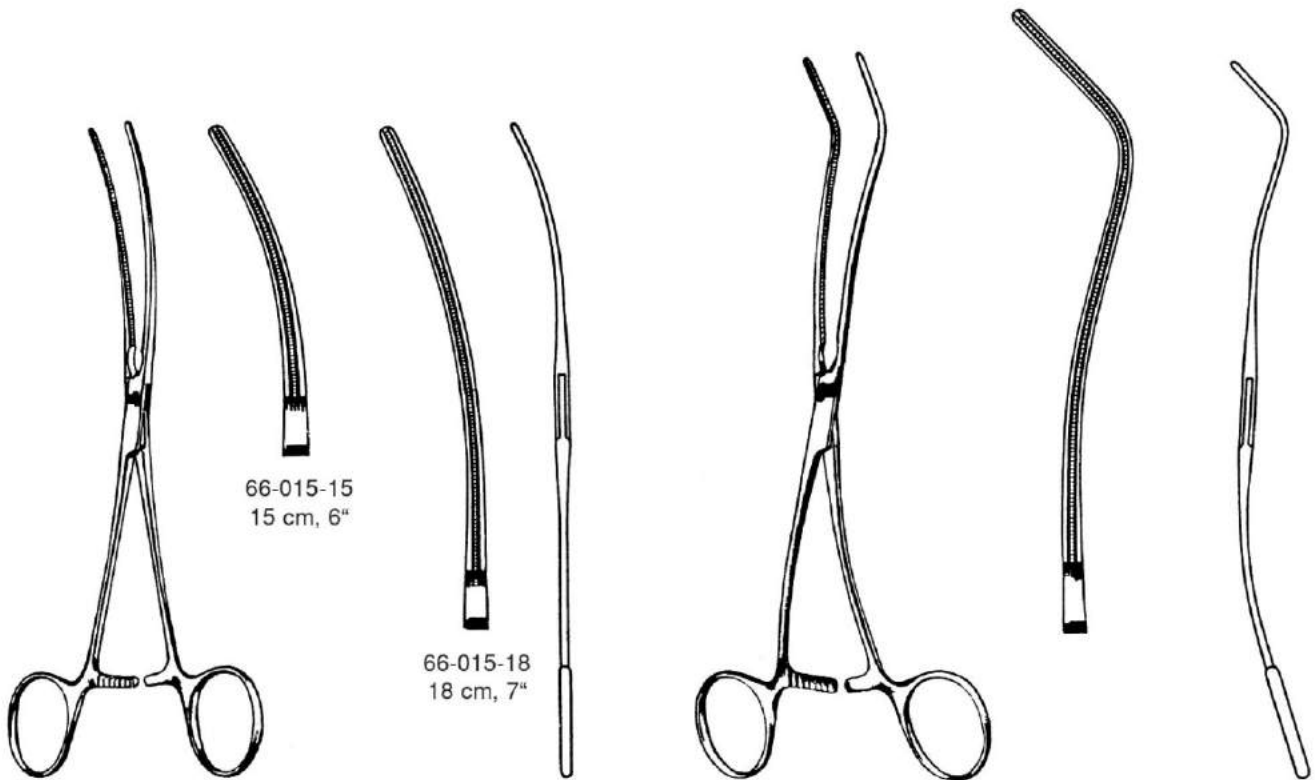

**BAINBRIDGE**  
66-015-15 66-015-18

**DE BAKEY**  
66-016-20  
20 cm, 8"



Atraumatic Aortic Aneurysm Clamps  
Pinzas-clamps para aneurisma de la aorta



66-017-26  
26 cm, 10 1/4"

66-017-27  
27 cm, 10 1/2"

66-017-31  
31 cm, 12 1/4"

66-017-33  
33 cm, 13"

DE BAKEY  
66-017-26 to 66-017-33





Aortic Aneurysm Clamp  
Pinzas-clamps para aneurisma de la aorta



DE BAKEY  
66-018-28  
28 cm, 11"



Atraumatic Aortic Aneurysm Clamps  
Pinzas-clamps para aneurisma de la aorta

Top View  
Vista de arriba  
Vista da vicino

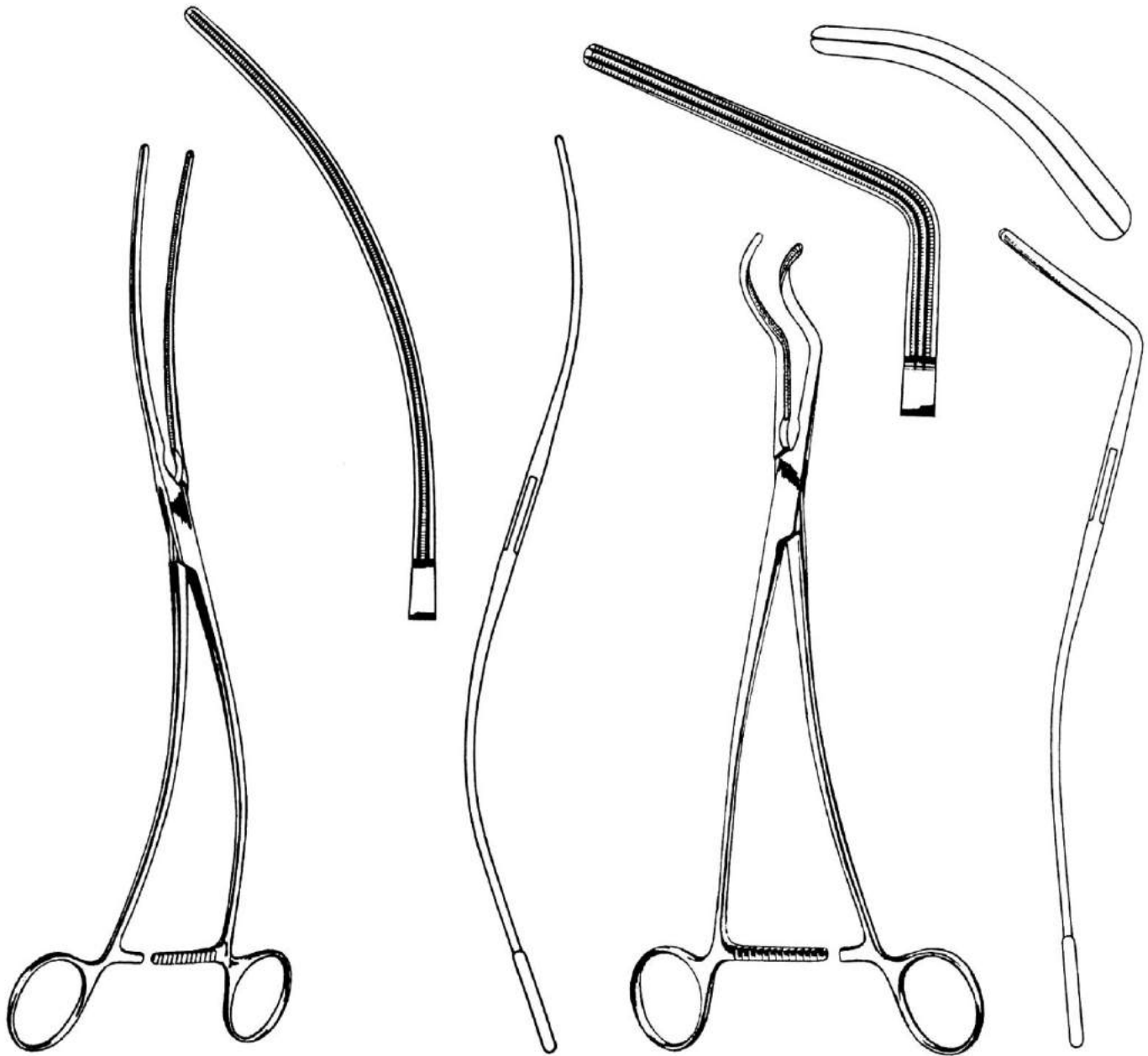

DE BAKEY  
66-019-30  
30 cm, 11 3/4"

DE BAKEY  
66-020-27  
27 cm, 10 1/2"



Ligature Clamps  
Pinzas-clamps para ligaduras

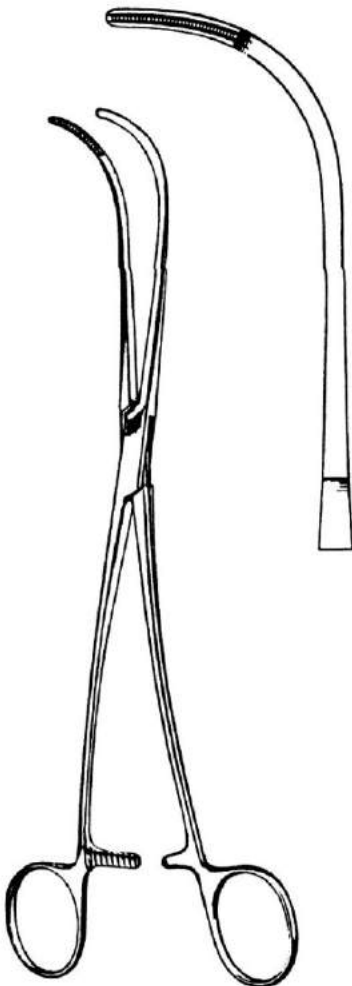

DE BAKEY  
66-021-24  
24 cm, 9 1/2"

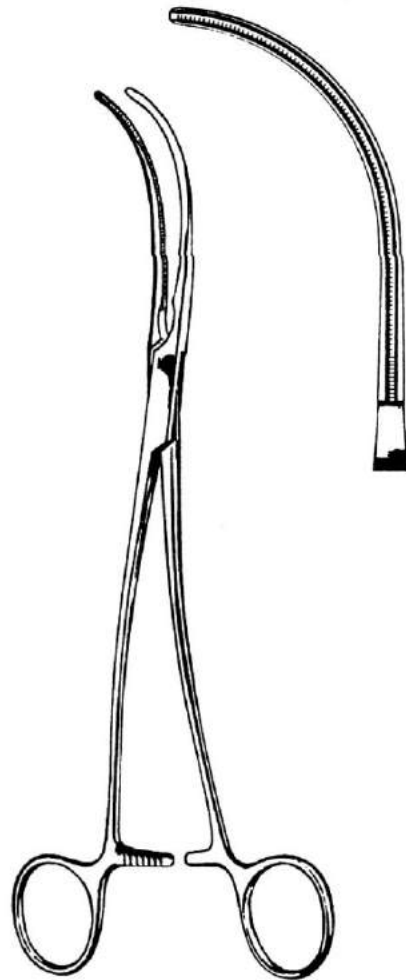

DE BAKEY  
66-022-24  
24 cm, 9 1/2"





Atraumatic Ligature Clamp, Aortic Clamp  
Pinzas clamps para ligaduras y de la aorta

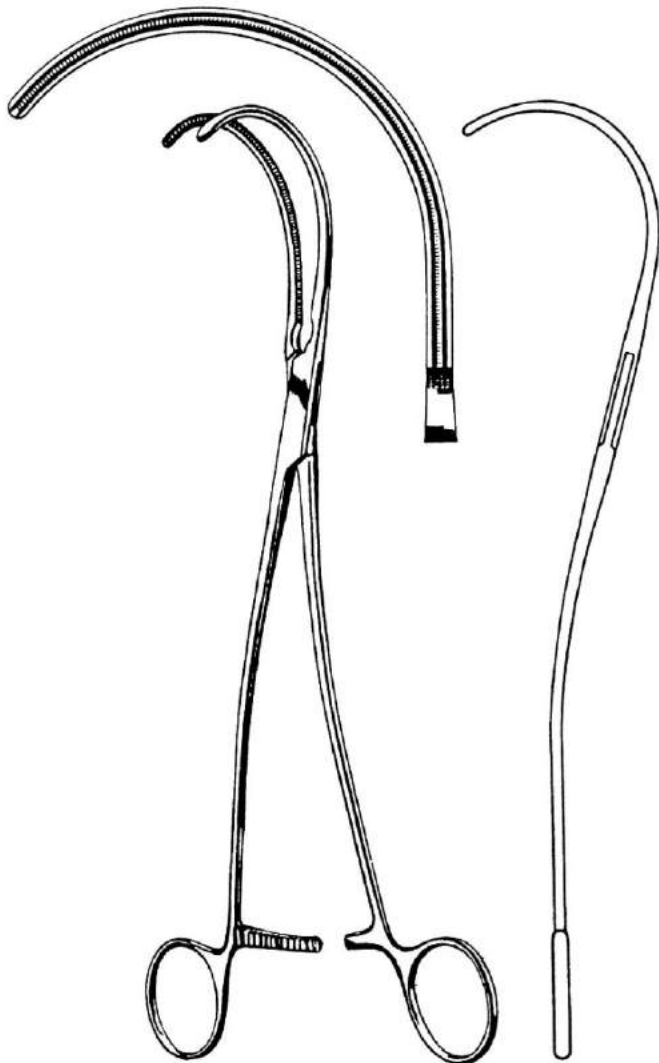

DE BAKEY  
66-023-26  
26 cm, 10 1/4"

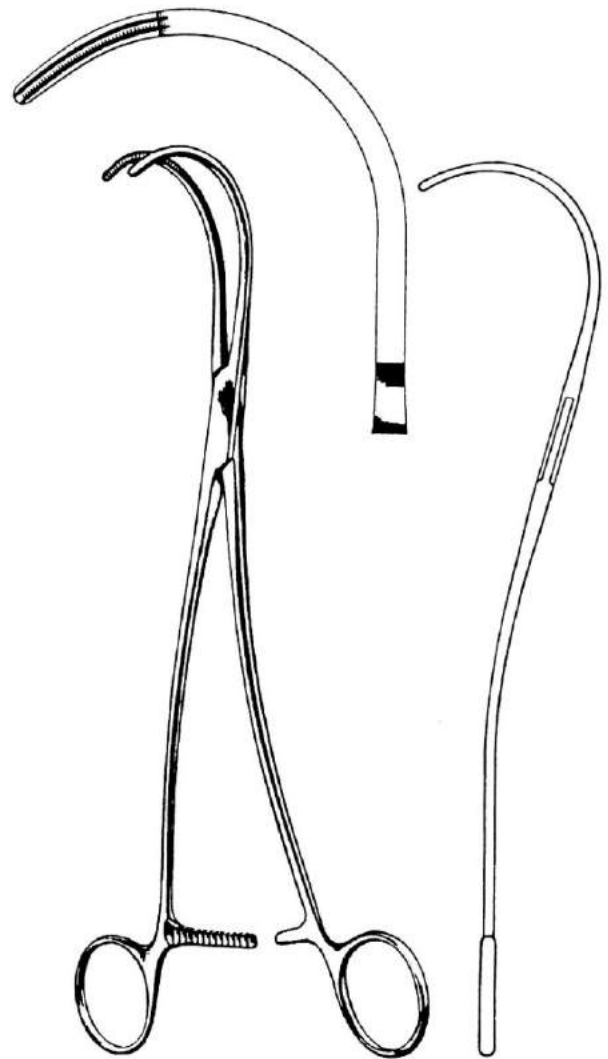

DE BAKEY  
66-023-25  
25 cm, 10"



Aortic Clamps  
Pinzas-clamps para la aorta

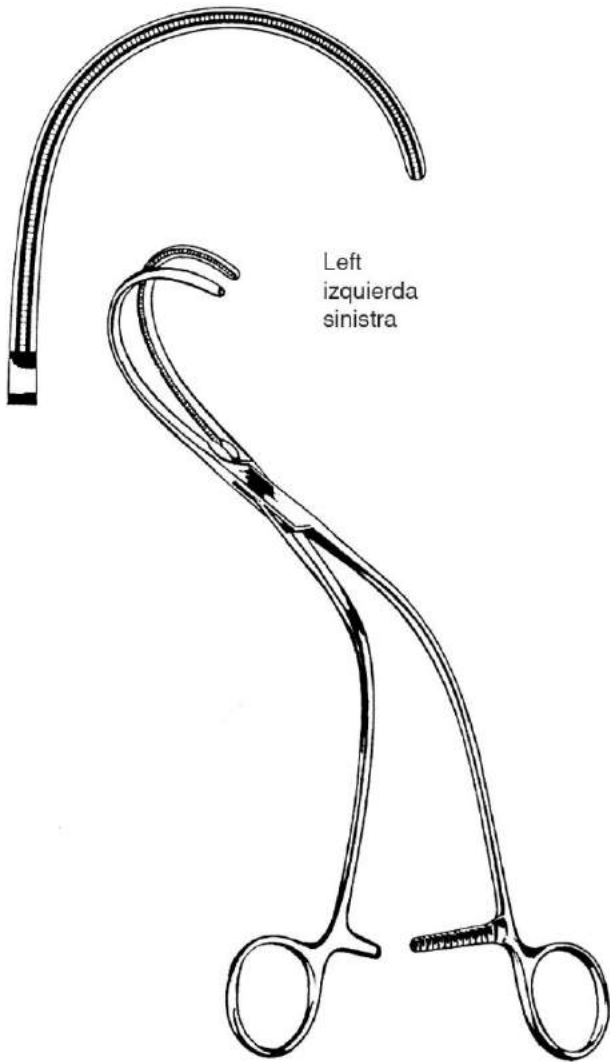

Left  
izquierda  
sinistra

WEBER  
66-024-01  
26 cm, 10 1/4"

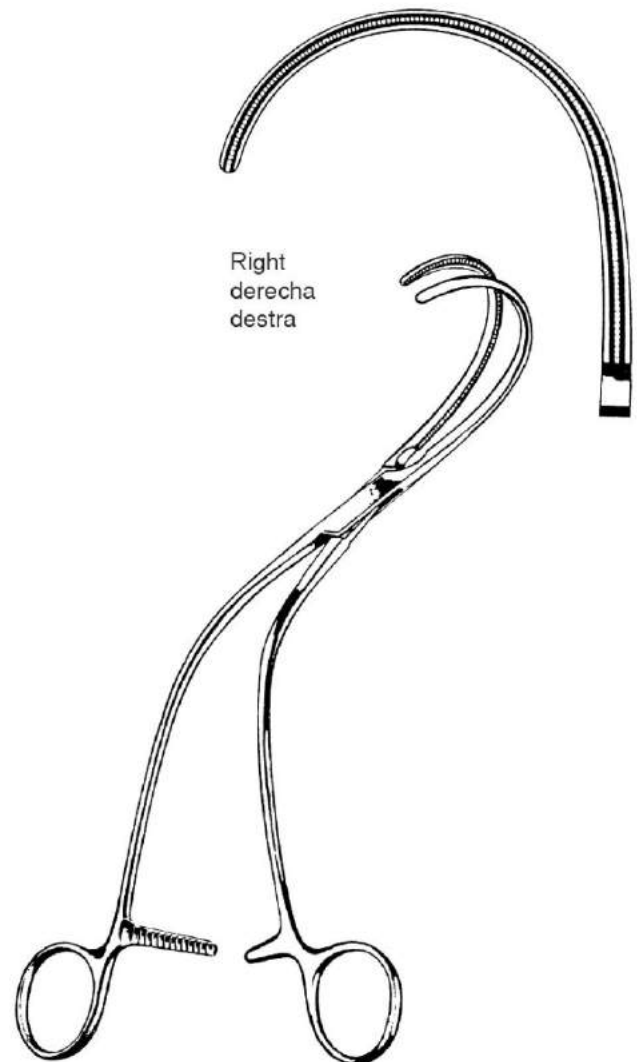

Right  
derecha  
destra

WEBER  
66-024-02  
26 cm, 10 1/4"



Atraumatic Tangential Occlusion Clamps  
Pinzas-clamps para oclusión tangencial

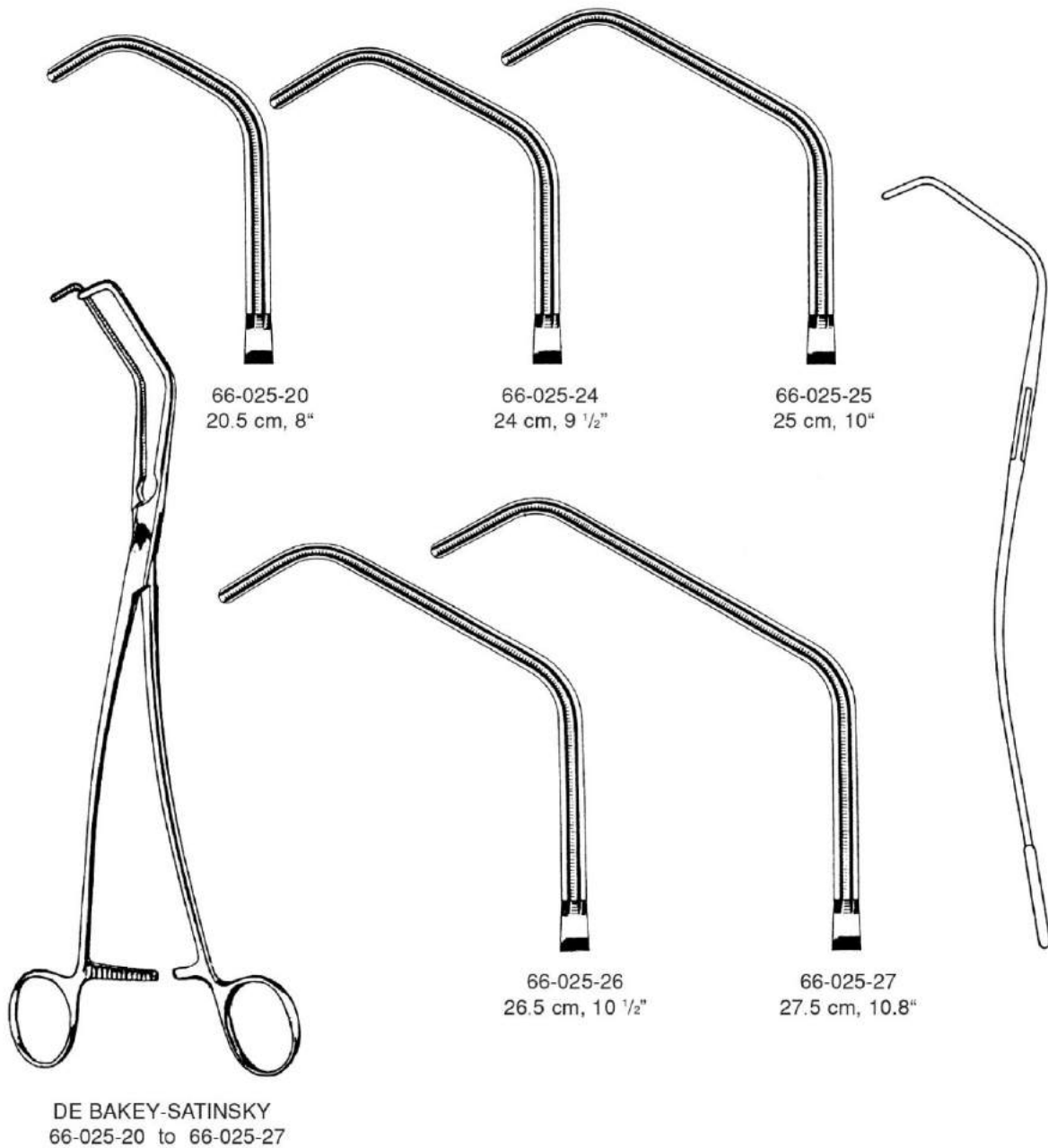



Auricle Clamps  
Pinza-clamps auriculares

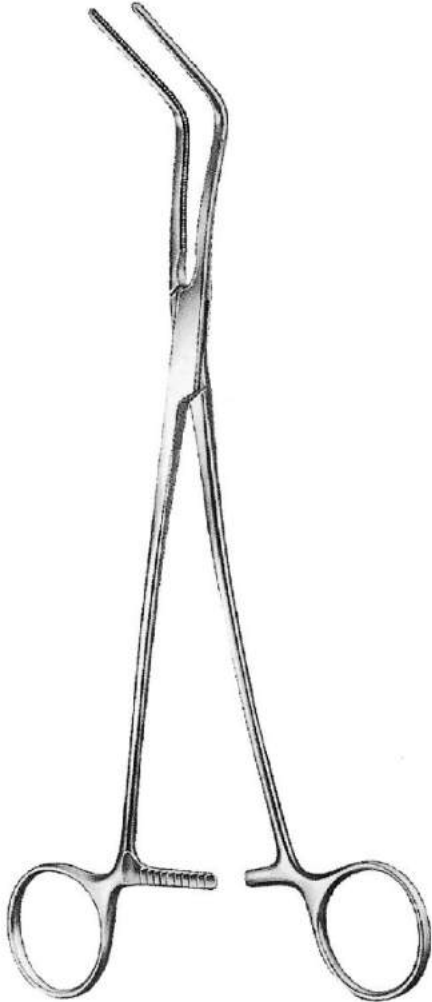

HARKEN  
66-026-01 to 66-026-04



66-026-01  
24 cm, 9 1/2"



66-026-02  
24 cm, 9 1/2"

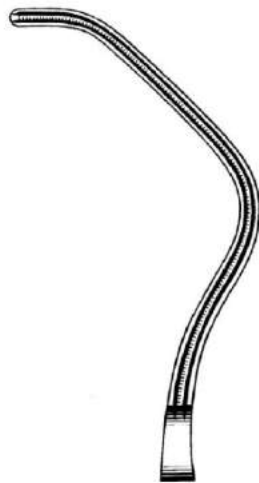

66-026-03  
24 cm, 9 1/2"

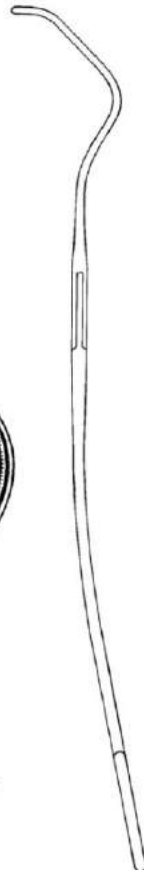

66-026-04  
24 cm, 9 1/2"



Atraumatic Bronchus Clamp  
Pinzas-clamps bronquiales

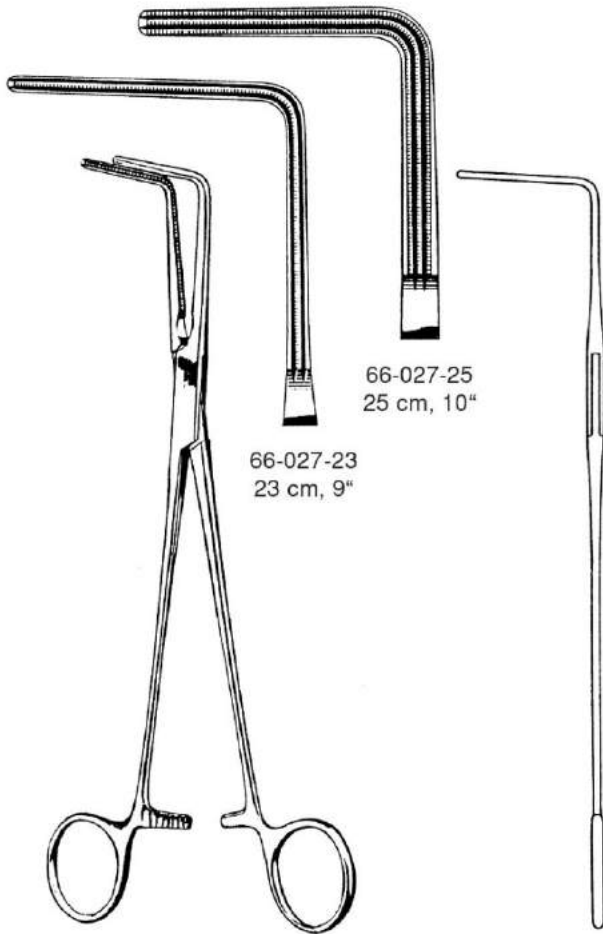

LEES  
66-027-23 66-027-25

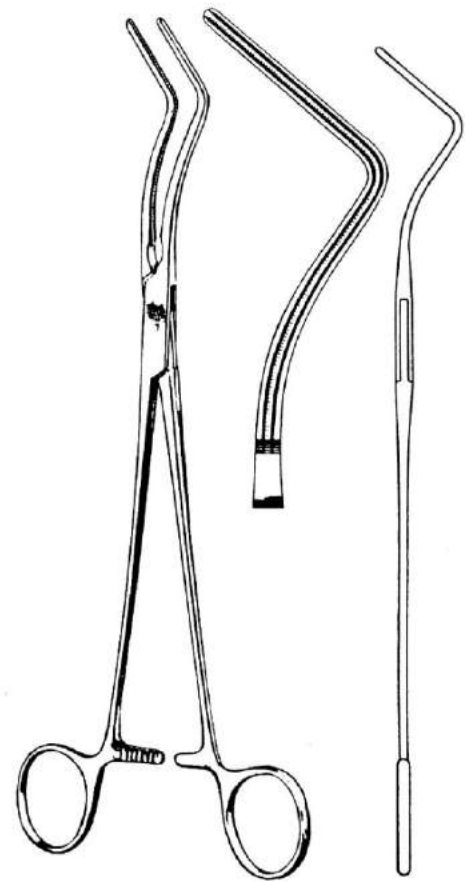

LEES  
66-029-25  
25 cm, 10"





Aortic Anastomosis Clamps  
Pinzas-clamps para anastomosis

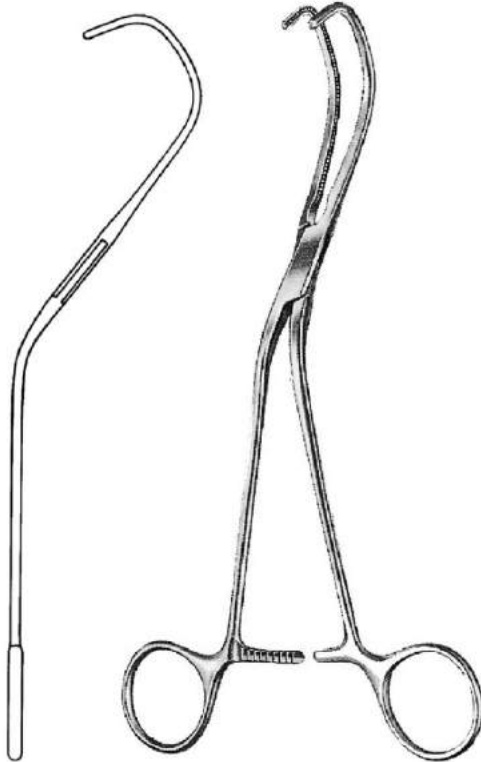

LAMBERT-KAY  
21 cm, 8 1/4"  
66-030-21 66-030-22

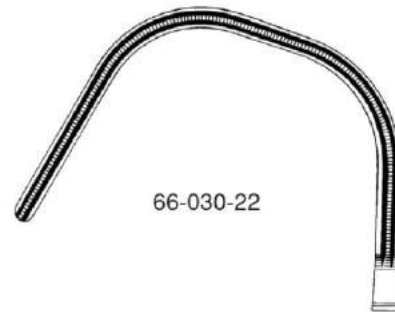

66-030-22



66-030-21

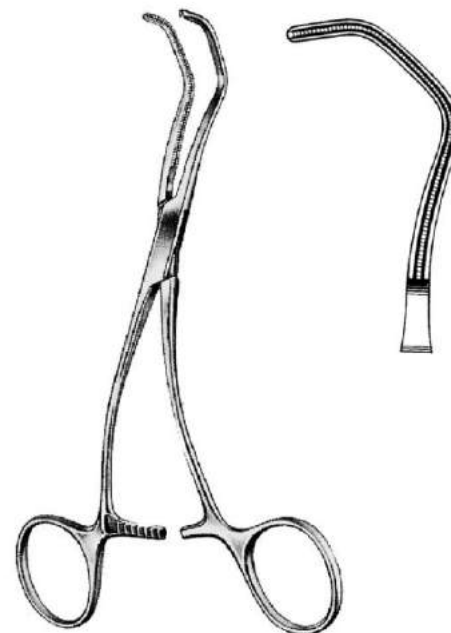

DE BAKY  
66-031-17  
17 cm, 6 3/4"



Atraumatic Aortic Aneurysm Clamps - Iliac Artery  
 Pinzas-clamps para aneurisma de la arteria iliaca



MORRIS-DE BAKEY  
 66-032-18 to 66-032-25

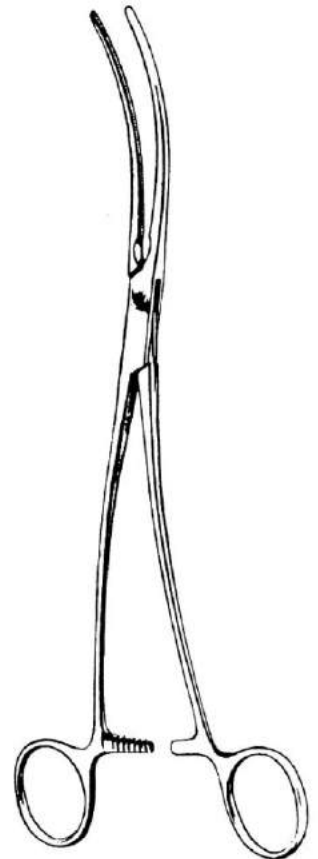
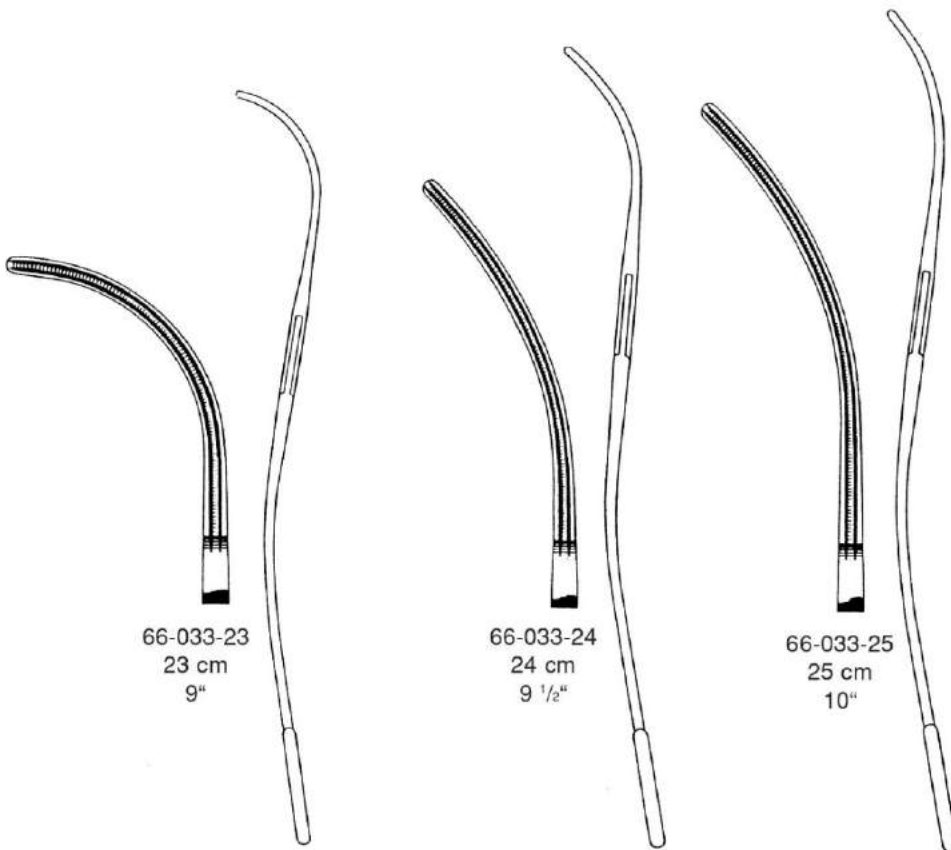
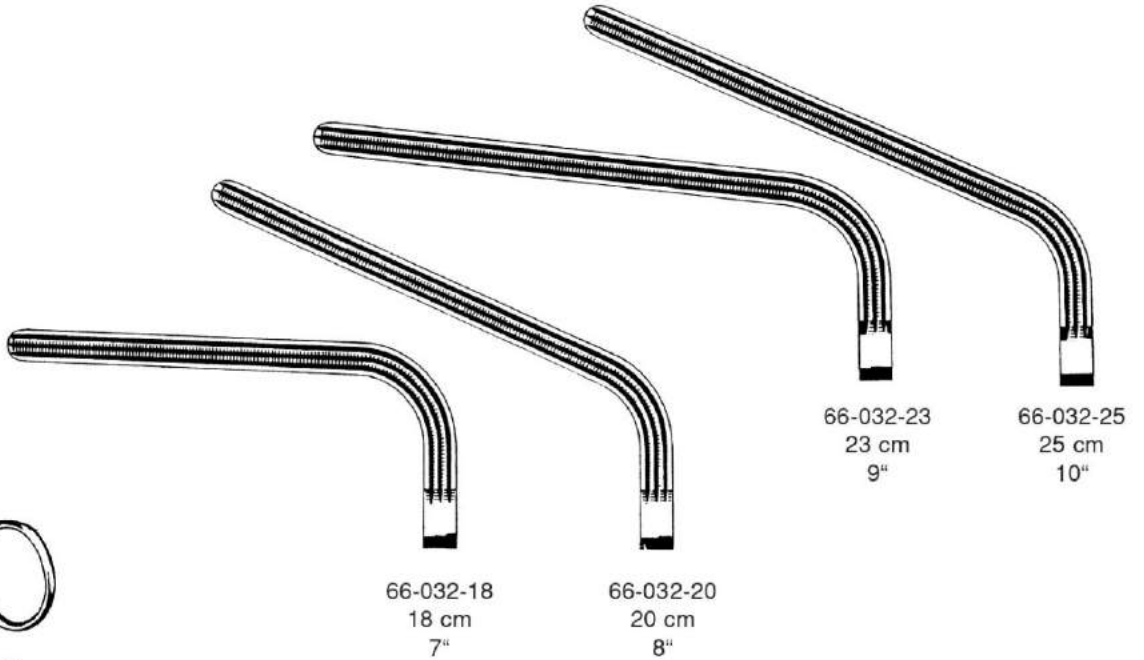

DE BAKEY-BAHNSON  
 66-033-23 to 66-033-25



Coarctation Clamps  
Pinzas-clamps para coartación



DE BAKEY  
66-034-21 to 66-034-31



66-034-21  
21.5 cm  
8 1/2"



66-034-23  
23 cm  
9"



66-034-27  
27 cm  
10 1/2"



66-034-31  
31.5 cm  
12 1/2"

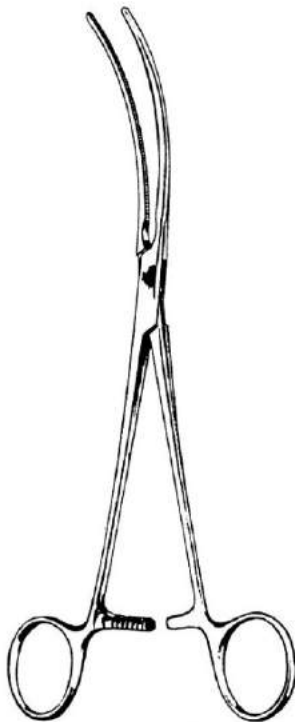

DE BAKEY  
66-035-21 to 66-035-31



66-035-21  
21.5 cm  
8 1/2"



66-035-23  
23 cm  
9"



66-035-27  
27 cm  
10 1/2"



66-035-31  
31 cm  
12 1/4"



Atraumatic Multi Purpose Clamps  
Pinzas-clamps para usos varios

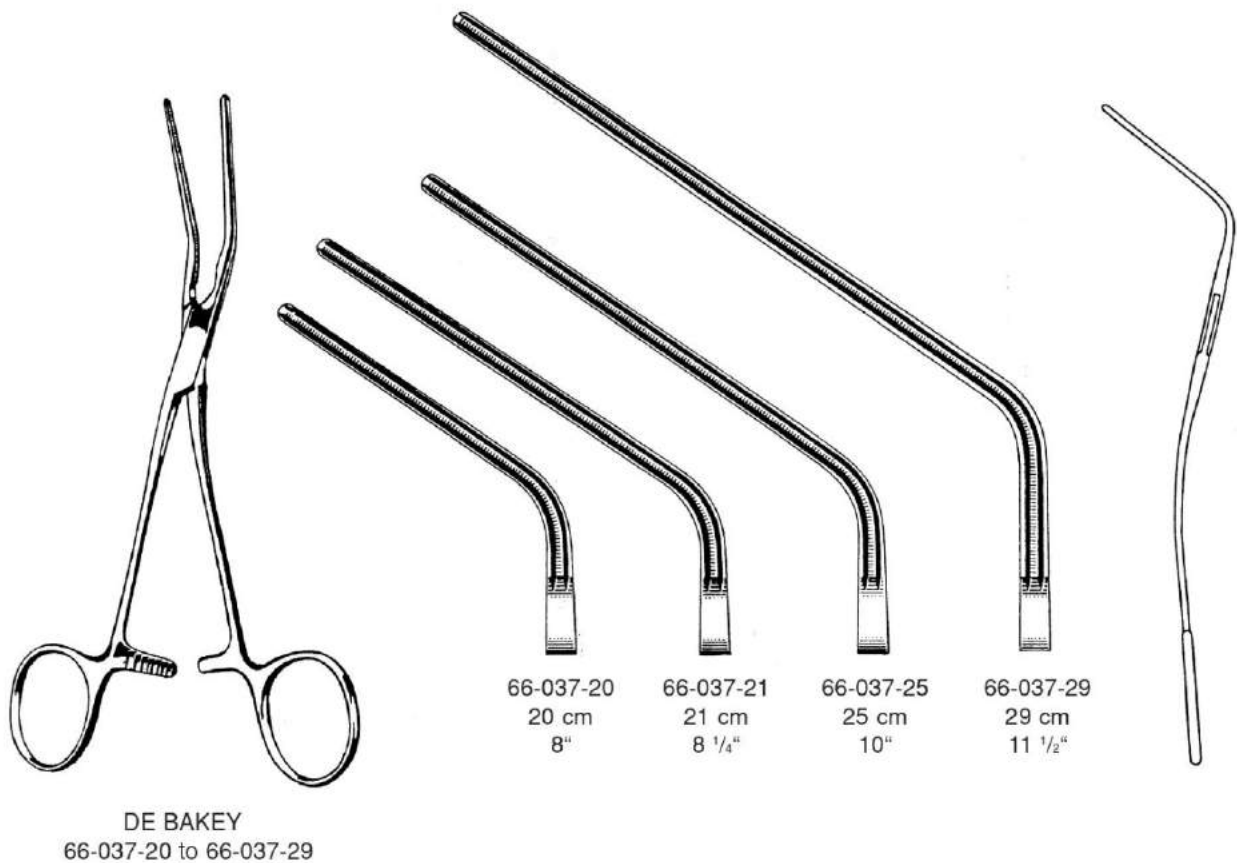
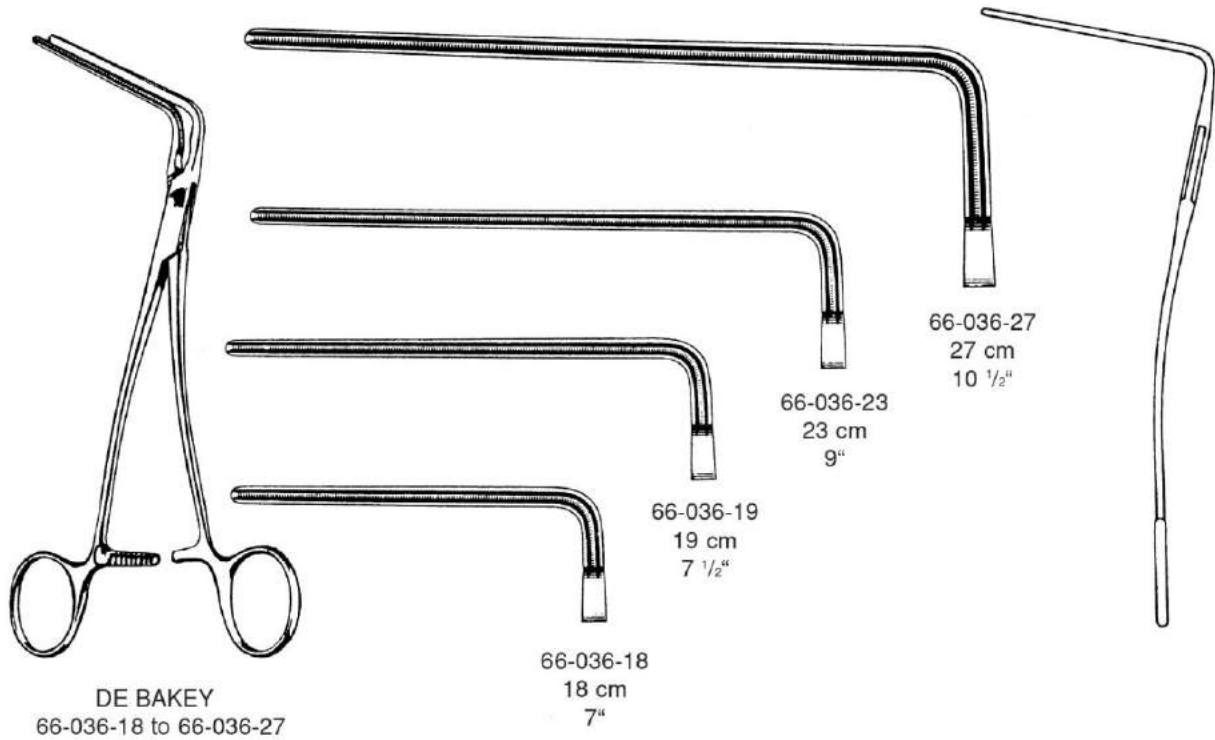



Atraumatic Hemostatic Forceps  
Pinzas hemostáticas atraumáticas

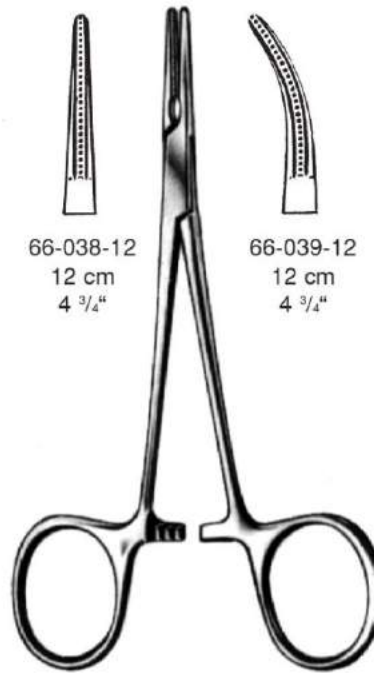

66-038-12  
12 cm  
4 <sup>3</sup>/<sub>4</sub>"

66-039-12  
12 cm  
4 <sup>3</sup>/<sub>4</sub>"

DE BAKEY Mosquito  
66-038-12 66-039-12



Atraumatic Aortic Clamps, Carotid Clamps  
 Pinzas-clamps para aorta, Pinzas-clamps para carotis

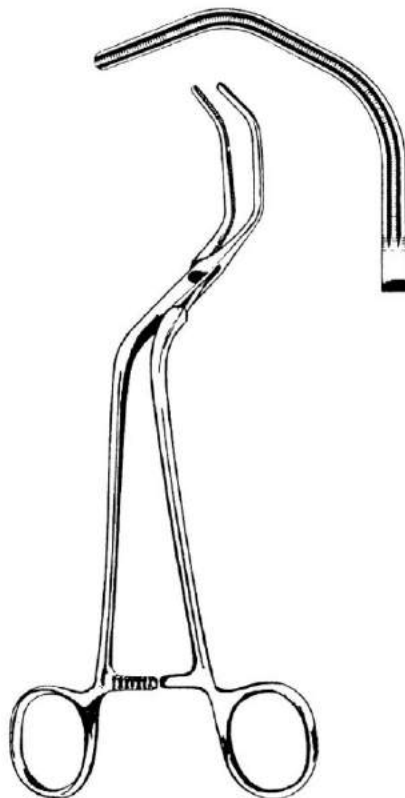

DIETHRICH  
 66-040-21 21 cm, 8 1/4"

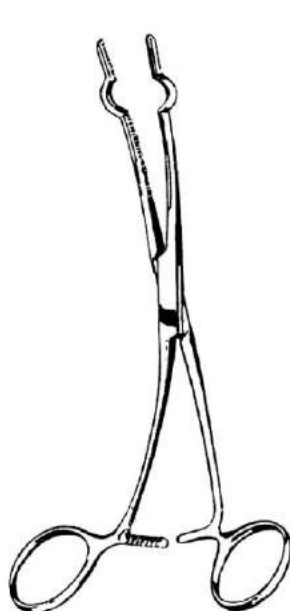

COOLEY  
 66-050-01 to 66-050-07

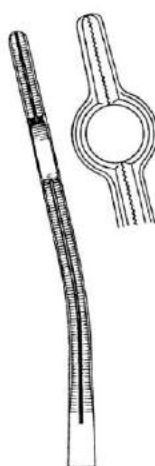

Charrière French	Length Largo Lungo cm		
24	16	6 1/4"	66-050-01
26	16	6 1/4"	66-050-02
28	20	8"	66-050-03
30	20	8"	66-050-04
32	20	8"	66-050-05
36	20	8"	66-050-07

66-050-01 66-050-02  
 For Children  
 para niños  
 per bambini

66-050-03 to 66-050-07  
 For Adults  
 para adultes  
 per adulti



Carotid Shunt Clamps  
Pinzas para shunt carótido

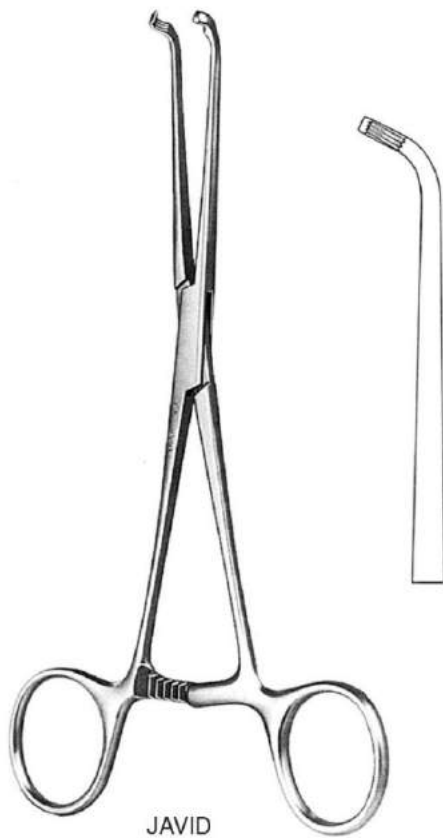

JAVID  
66-045-18  
18 cm, 7"



JAVID  
66-046-19  
19 cm, 7.5"



Atraumatic Cardiovascular Forceps  
Pinzas-clamps cardiovasculares

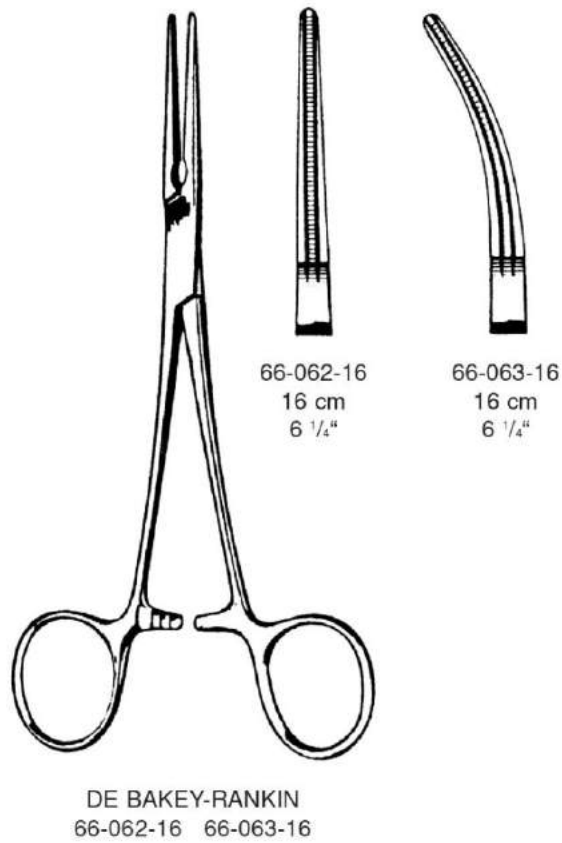





Atraumatic Cardiovascular Forceps  
Pinzas-clamps cardiovasculares

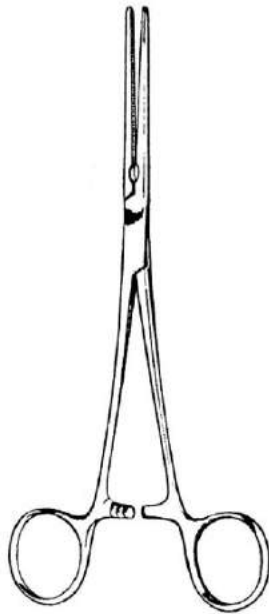

DE BAKEY-PEAN  
66-138-14 to 66-138-20



66-138-14  
14 cm  
5 1/2"



66-138-16  
16 cm  
6 1/4"



66-138-18  
18 cm  
7"



66-138-20  
20 cm  
8"

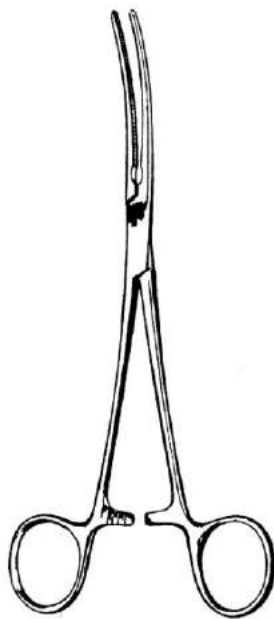

DE BAKEY-PEAN  
66-139-14 to 66-139-20



66-139-14  
14 cm  
5 1/2"



66-139-16  
16 cm  
6 1/4"



66-139-18  
18 cm  
7"



66-139-20  
20 cm  
8"



Atraumatic Cardiovascular Forceps  
Pinzas-clamps cardiovasculares

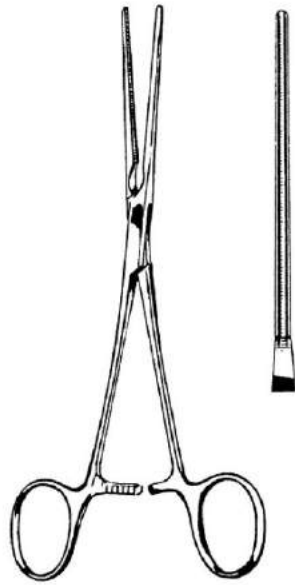

DE BAKEY  
66-140-17  
17 cm, 6 3/4"

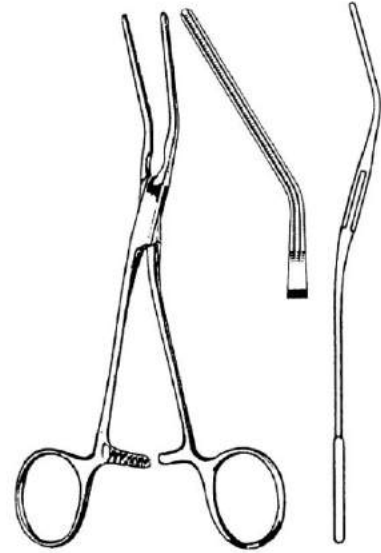

DE BAKEY  
66-141-16  
16 cm, 6 1/4"

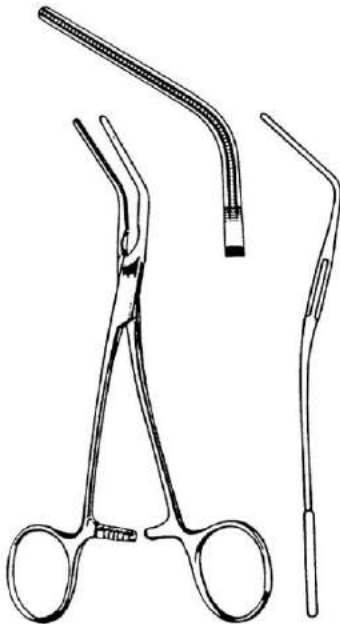

DE BAKEY  
66-143-15  
15 cm, 6"



DE BAKEY  
66-145-15  
15 cm, 6"

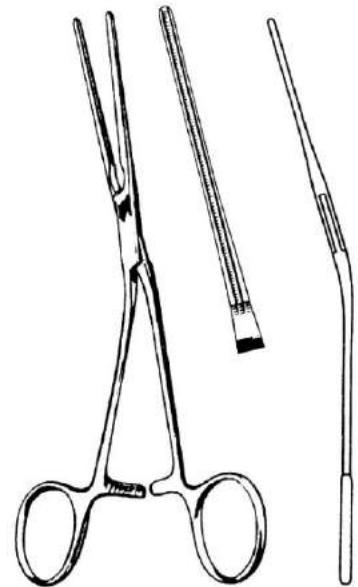

DE BAKEY  
66-147-17  
17 cm, 6 3/4"



Atraumatic Cardiovascular Forceps  
Pinzas-clamps cardiovasculares atraumáticas

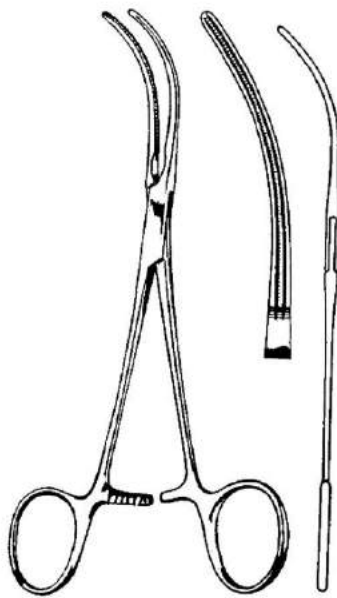

GLOVER  
66-149-17  
17 cm, 6 3/4"

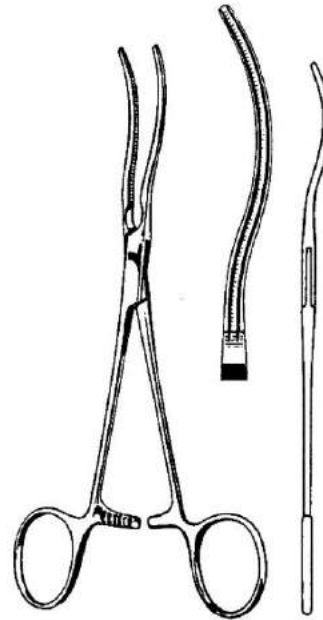

DE BAKEY  
66-151-17  
17 cm, 6 3/4"

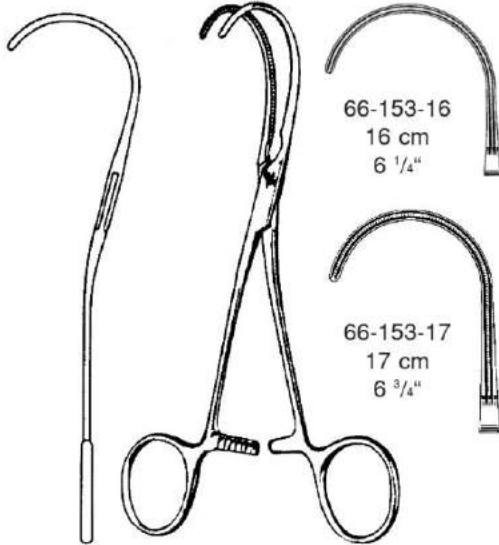

DE BAKEY  
66-153-16 66-153-17

66-153-16  
16 cm  
6 1/4"

66-153-17  
17 cm  
6 3/4"

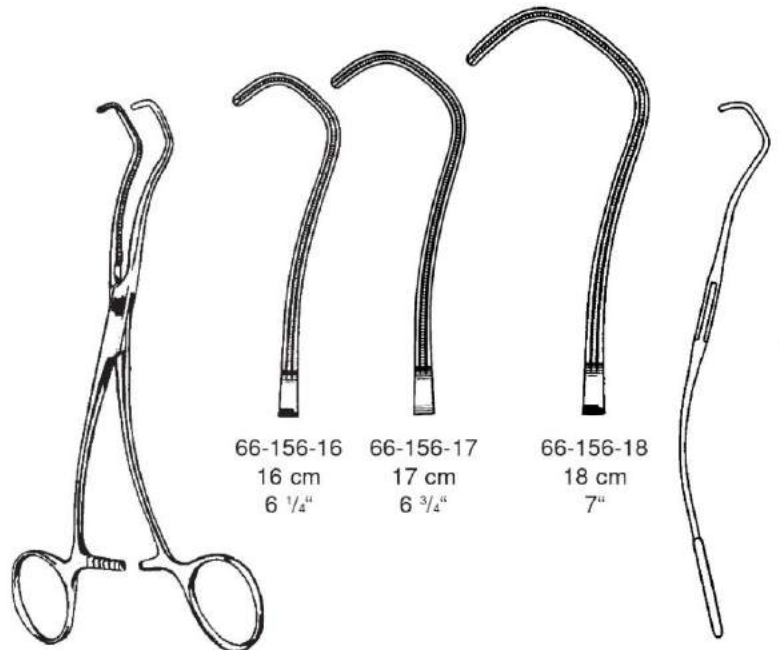

DERRA  
66-156-16 to 66-156-18

66-156-16  
16 cm  
6 1/4"

66-156-17  
17 cm  
6 3/4"

66-156-18  
18 cm  
7"

Atraumatic Cardiovascular Forceps  
Pinzas-clamps cardiovasculares atraumáticas

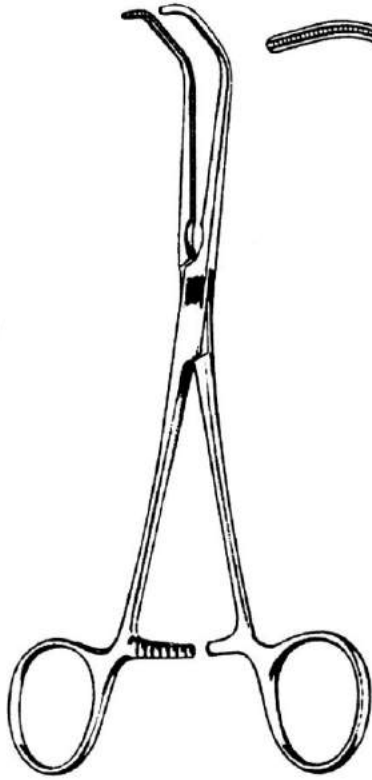

BECK  
66-157-17 17 cm, 6 <sup>3</sup>/<sub>4</sub>"

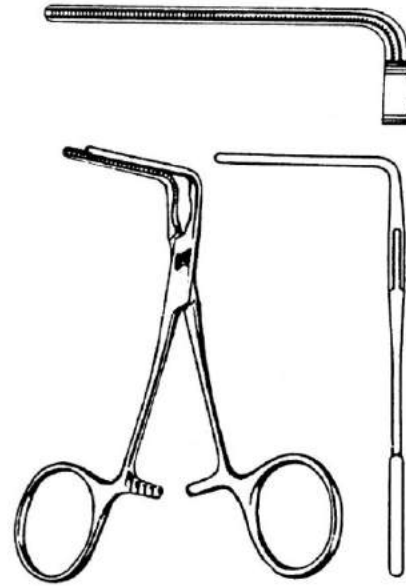

DE BAKEY  
66-158-10 10 cm, 4"

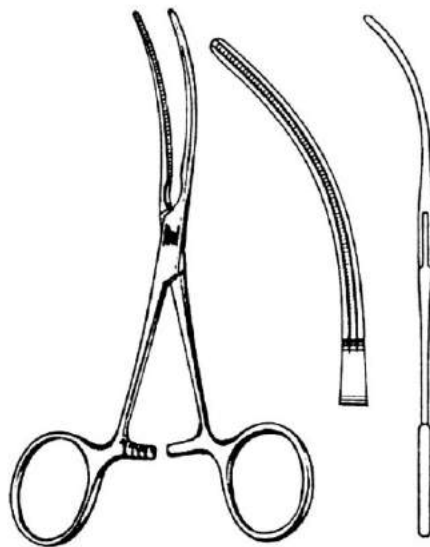

DE BAKEY  
66-158-11 11 cm, 4 <sup>3</sup>/<sub>8</sub>"



Atraumatic Cardiovascular Forceps  
Pinzas-clamps cardiovasculares atraumáticas

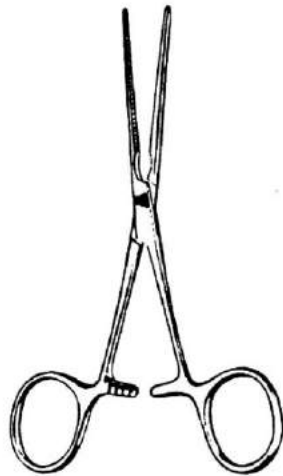

DE BAKEY  
66-158-12 12 cm, 4 <sup>3</sup>/<sub>4</sub>"

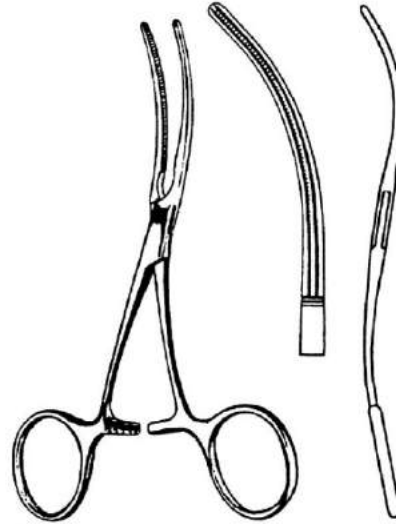

DE BAKEY  
66-159-12 11.5 cm, 4 <sup>1</sup>/<sub>2</sub>"

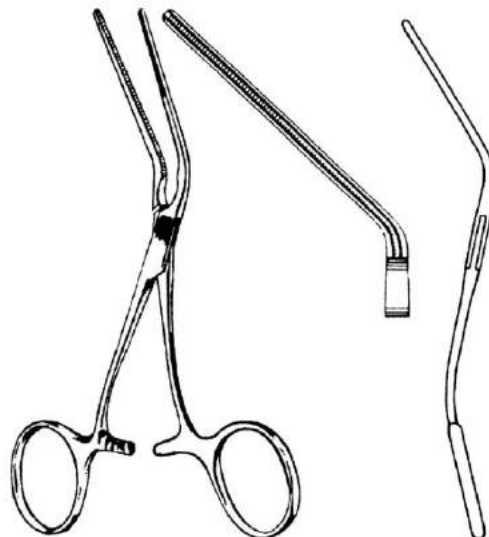

DE BAKEY  
66-159-13 13 cm, 5 <sup>1</sup>/<sub>8</sub>"



Atraumatic Cardiovascular Forceps  
 Pinzas-clamps cardiovasculares atraumáticas

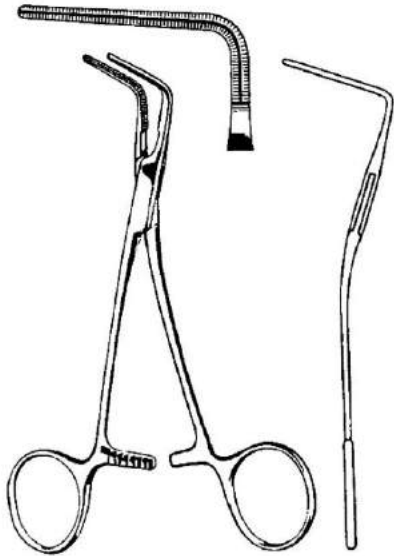

COOLEY  
 66-172-15  
 15 cm, 6"

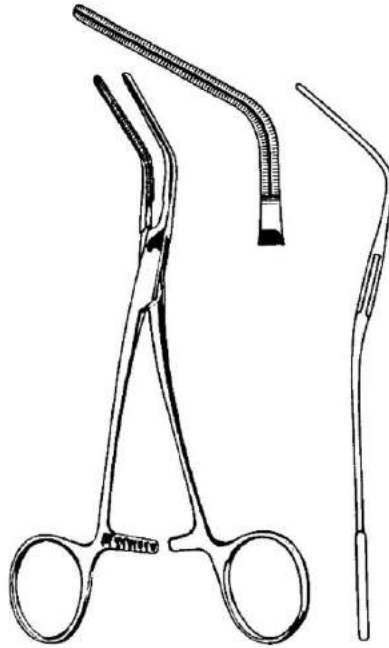

COOLEY  
 66-173-16  
 15.5 cm, 6"

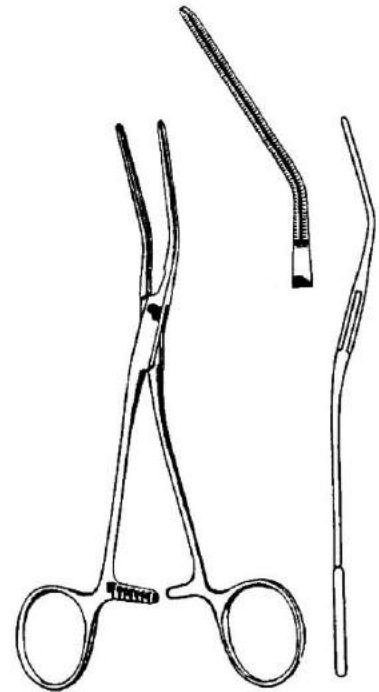

COOLEY  
 66-174-17  
 17 cm, 6 3/4"

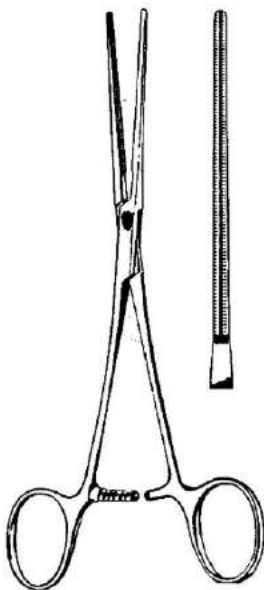

COOLEY  
 66-175-17  
 17 cm, 6 3/4"

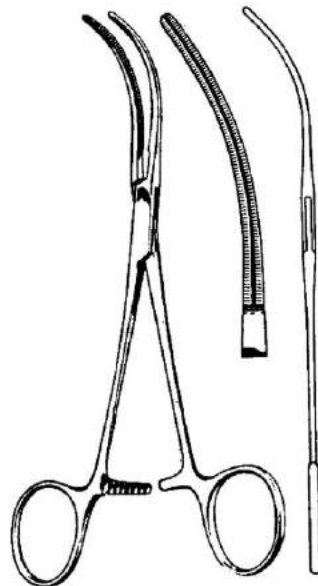

COOLEY  
 66-176-17  
 17 cm, 6 3/4"

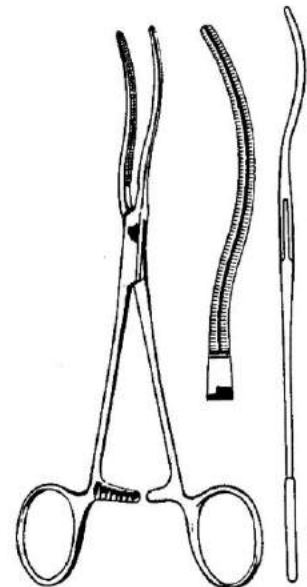

COOLEY  
 66-177-17  
 17 cm, 6 3/4"



## Atraumatic Cardiovascular Forceps Pinzas-clamps cardiovasculares atraumáticas

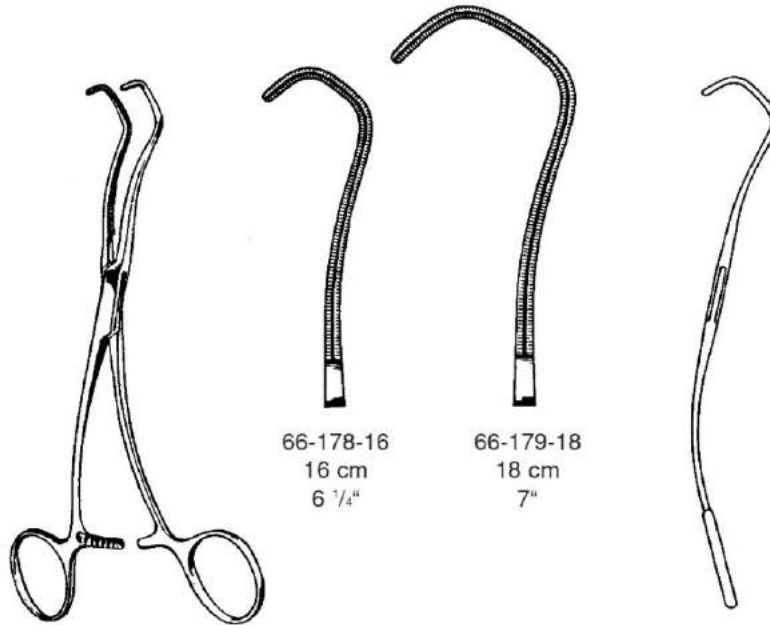

66-178-16  
16 cm  
6 1/4"

66-179-18  
18 cm  
7"

COOLEY-DERRA  
66-178-16 66-179-18

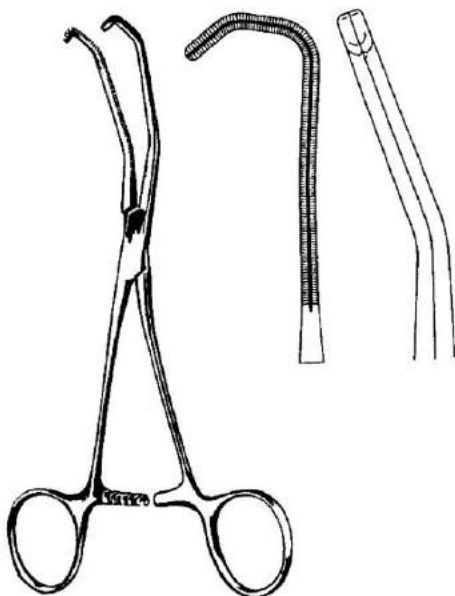

COOLEY  
66-180-17  
17 cm, 6 3/4"

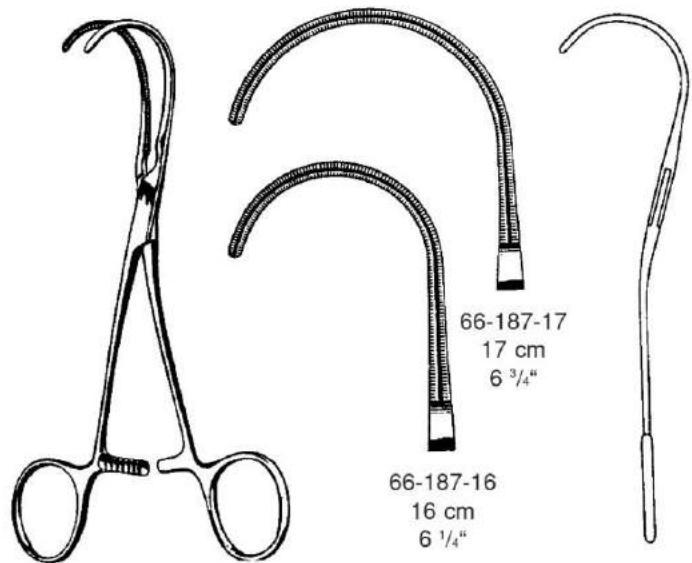

66-187-17  
17 cm  
6 3/4"

66-187-16  
16 cm  
6 1/4"

COOLEY  
66-187-16 66-187-17



Carotid Clamps, Iliac Clamp, Anastomosis Clamp  
 Pinzas-clamps para carotis, Pinza clamp para iliac y anastomosis

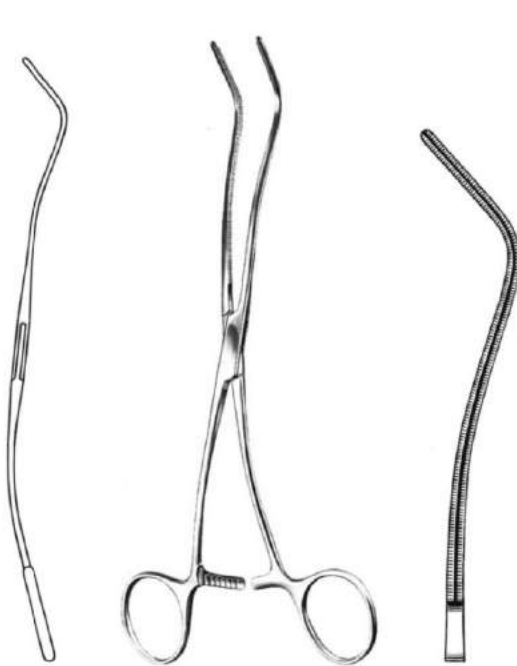

COOLEY  
 66-188-20 20 cm, 8"

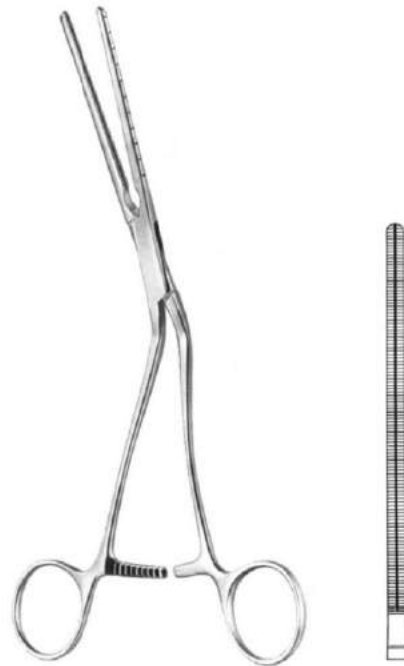

COOLEY  
 66-189-21 21 cm, 8 1/4"



BECK  
 66-190-17  
 17 cm, 6 3/4"



COOLEY  
 66-191-16  
 16 cm, 6 1/4"



COOLEY  
 66-192-17  
 17 cm, 6 3/4"





Atraumatic Cardiovascular Forceps  
Pinzas-clamps cardiovasculares atraumáticas

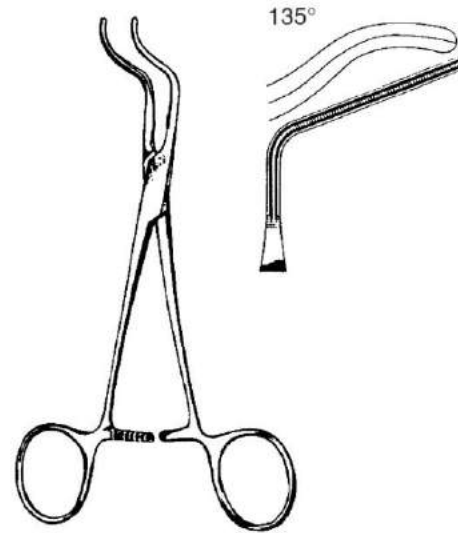

SUBRAMANIAN-MINIATURE  
66-259-15 15.5 cm, 6"

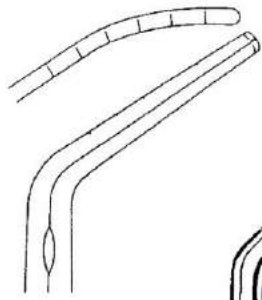

Right  
derecha  
destra

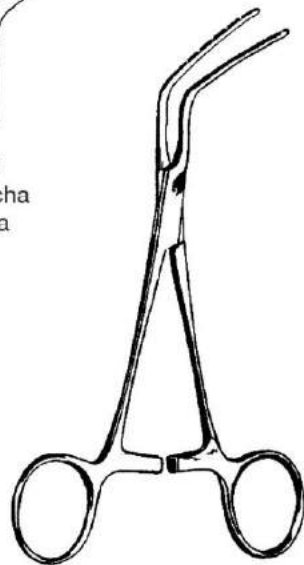

SUBRAMANIAN  
66-261-16 16 cm, 6 1/4"

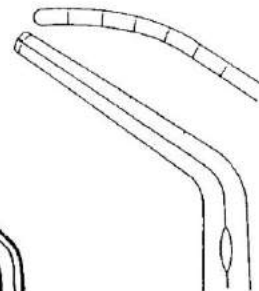

Left  
izquierda  
sinistra

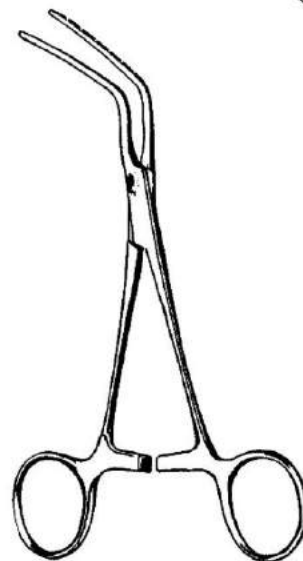

SUBRAMANIAN  
66-263-16 16 cm, 6 1/4"



Atraumatic and Pediatric Clamps, Delicate Patterns

Pinzas-clamps para recién nacidos y pediátricos, Modelos muy delicados, atraumáticos

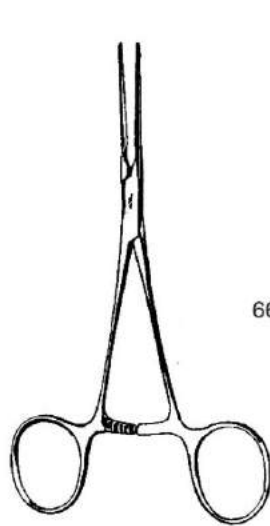

66-266-01  
14 cm  
5 1/2"



66-266-02  
14 cm  
5 1/2"

COOLEY  
66-266-01 66-266-02  
14 cm, 5 1/2"

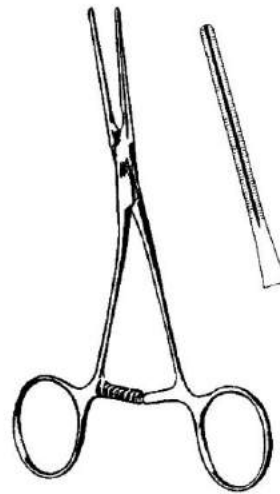

COOLEY  
66-266-03 14 cm, 5 1/2"

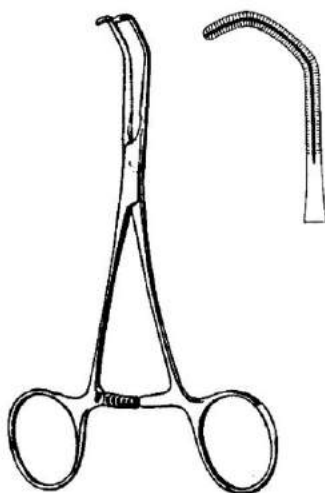

COOLEY  
66-266-04 14 cm, 5 1/2"

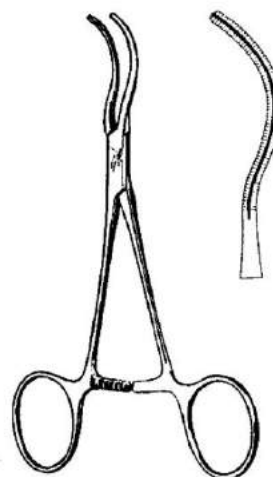

COOLEY  
66-266-05 14 cm, 5 1/2"



## Neonatal and Pediatric Clamps Pinzas-clamps pediátricas y para recién-nacidos, atraumáticas

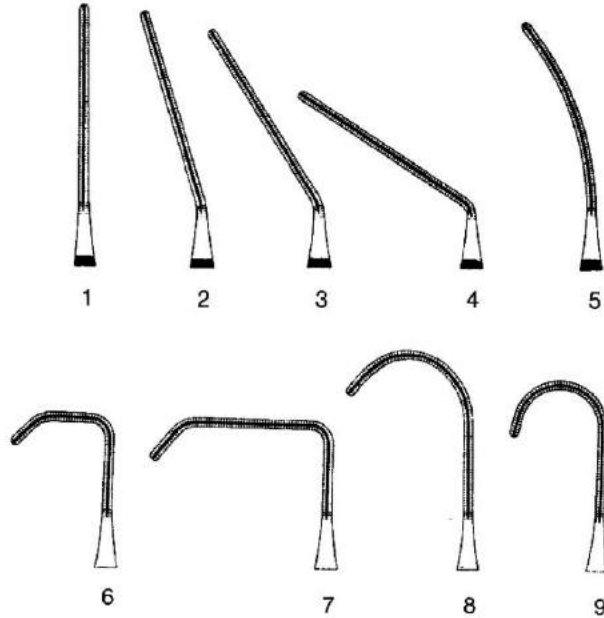
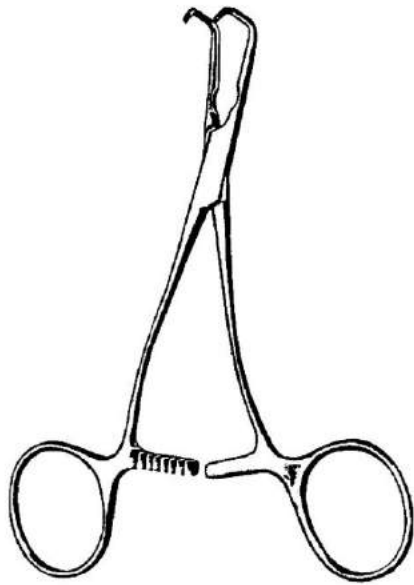

Fig.	Straight rectas rette
1	66-372-01 14 cm, 5 1/2"
2	66-372-02 14 cm, 5 1/2"
3	66-372-03 14 cm, 5 1/2"
4	66-372-04 13 cm, 5 1/8"
5	66-372-05 14 cm, 5 1/2"
6	66-372-06 13 cm, 5 1/8"
7	66-372-07 13 cm, 5 1/8"
8	66-372-08 14 cm, 5 1/2"
9	66-372-09 13.5 cm, 5 1/4"



Fig.	Curved curvas curve
1	66-373-01 14 cm, 5 1/2"
2	66-373-02 14 cm, 5 1/2"
3	66-373-03 14 cm, 5 1/2"
4	66-373-04 13 cm, 5 1/8"
5	66-373-05 14 cm, 5 1/2"
6	66-373-06 13 cm, 5 1/8"
7	66-373-07 13 cm, 5 1/8"
8	66-373-08 14 cm, 5 1/2"
9	66-373-09 13.5 cm

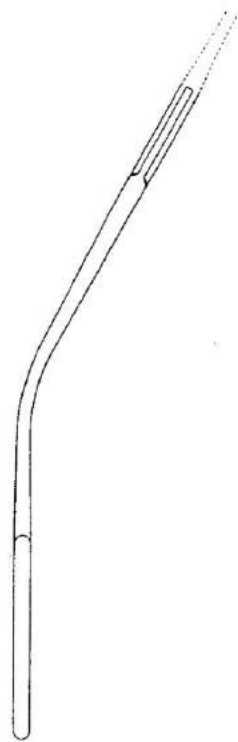

Fig.	Angled acodadas angolate
1	66-374-01 14 cm, 5 1/2"
2	66-374-02 14 cm, 5 1/2"
3	66-374-03 14 cm, 5 1/2"
4	66-374-04 13 cm, 5 1/8"
5	66-374-05 14 cm, 5 1/2"
6	66-374-06 13 cm, 5 1/8"
7	66-374-07 13 cm, 5 1/8"
8	66-374-08 14 cm, 5 1/2"
9	66-374-09 13.5 cm, 5 1/4"





## Clip Appliers for Open Surgery 25° Upcurved Pinza aplicadora de clips para Cirugía abierta con ángulo de 25°



15 cm

### SLS Clips

- 66-464-15 Micro White / blanc / blanco / bianco
- 66-465-15 Small Yellow / jaune/ Amarillo/ giallo
- 66-466-15 Small Medium lilac / lilas / lila / lilla
- 66-467-15 Medium Blue / bleu / azul / blu

### Pilling Type

- 66-481-15 Small Yellow / jaune / Amarillo / giallo
- 66-482-15 Medium Blue / bleu / azul / blu

### Ethicon Type

- 66-470-15 Small Blue / bleu / azul / blu
- 66-471-15 Medium White / blanc / blanco / bianco

### Horizon Tyoe

- 66-460-15 Small Blue/ bleu / azul / blu
- 66-461-15 Medium White / blanc / blanco / bianco

19 cm

### SLS Clips

- 66-464-19 Micro White / blanc / blanco / bianco
- 66-465-19 Small Yellow/ jaune / Amarillo / giallo
- 66-466-19 Small Medium lilac / lilas / lila / lilla
- 66-467-19 Medium Blue / bleu / azul / blu
- 66-468-19 Medium Large Green / vert verde / verde
- 66-469-19 Large Orange / naranja / arancione

### Pilling Type

- 66-481-19 Small Yellow / jaune / Amarillo / giallo
- 66-482-19 Medium Blue / bleu / azul / blu
- 66-484-19 Medium Large green / vert / verde
- 66-483-19 Large Orange / naranja / arancione

### Ethicon Type

- 66-470-19 Small Blue / bleu / azul / blu
- 66-471-19 Medium White / blanc / blanco / bianco
- 66-472-19 Medium Large green / vert / verde
- 66-473-19 Large Orange / naranja / arancione

### Horizon Type

- 66-460-19 Small Blue / bleu / azul
- 66-461-19 Medium White / blanc / blanco
- 66-462-19 Medium Large green / vert / verde
- 66-463-19 Large Orange / naranja / arancione





Clip Appliers for Open Surgery 25° Upcurved  
Pinza aplicadora de clips para Cirugía abierta con ángulo de 25°

28 cm

SLS Clips

- 66-464-28 Micro White / blanc / blanco
- 66-465-28 Small Yellow / jaune / amarillo
- 66-466-28 Small Medium lilas / lila
- 66-467-28 Medium Blue / bleu / azul
- 66-468-28 Medium Large Green / vert / verde
- 66-469-28 Large Orange / naranja

Pilling Type

- 66-482-28 Medium Blue / bleu / azul
- 66-484-28 Medium Large Green / vert / verde
- 66-483-28 Large Orange / naranja

Ethicon Type

- 66-471-28 Medium White / blanc / blanco
- 66-472-28 Medium Large Green / vert / verde
- 66-473-28 Large Orange / naranja

Horizon Type

- 66-461-28 Medium White / blanc / blanco
- 66-462-28 Medium Large Green / vert / verde
- 66-463-28 Large Orange / naranja





Atraumatic Cardiovascular Forceps, Extra Delicate Patterns  
Pinzas-clamps cardiovasculares, modelos muy delicados, atraumáticos

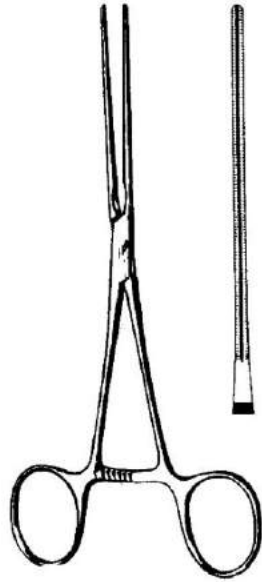

66-488-16  
16.5 cm, 6 1/2"

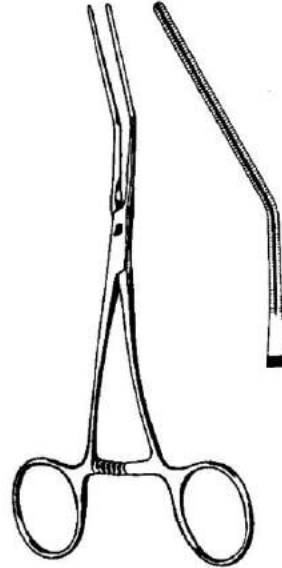

66-489-16  
16 cm, 6 1/4"



66-490-15  
15 cm, 6"

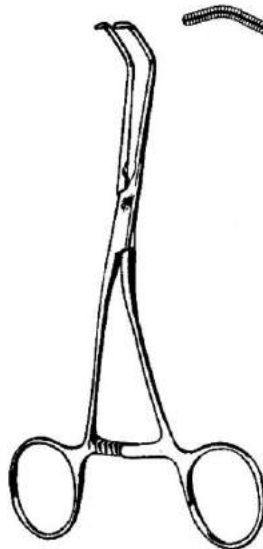

66-491-15  
15 cm, 6"

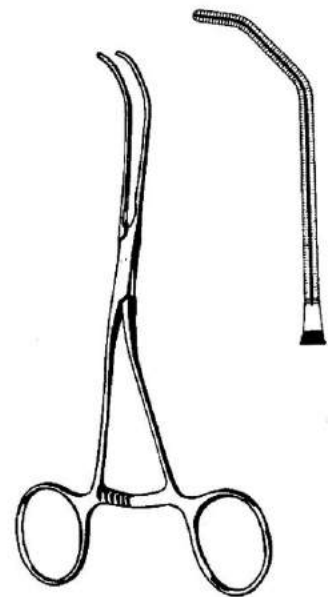

66-492-16  
16 cm, 6.25"



## Neonatal Pinzas-clamps para recién-nacidos



66-493-01  
13 cm  
5 1/8"



66-493-02  
13 cm  
5 1/8"



66-493-03  
11 cm  
4 3/8"

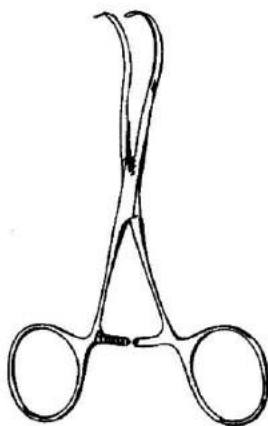

CASTANEDA  
66-493-01 to 66-495-04



66-495-01  
12 cm  
4 3/4"



66-495-02  
12 cm  
4 3/4"



66-495-03  
12 cm  
4 3/4"



66-495-04  
12 cm  
4 3/4"



## Aortic Dilators, Tourniquets Dilatadores de aorta, Torniquetes

Blade opening from 8 to 42 mm

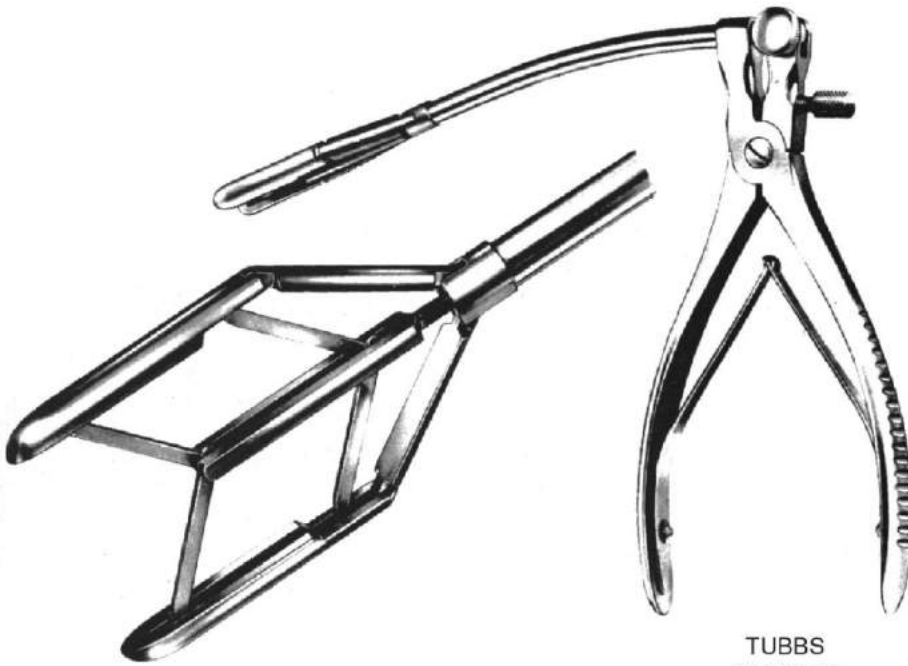

TUBBS  
66-500-00

Blade opening from 8 to 15 mm

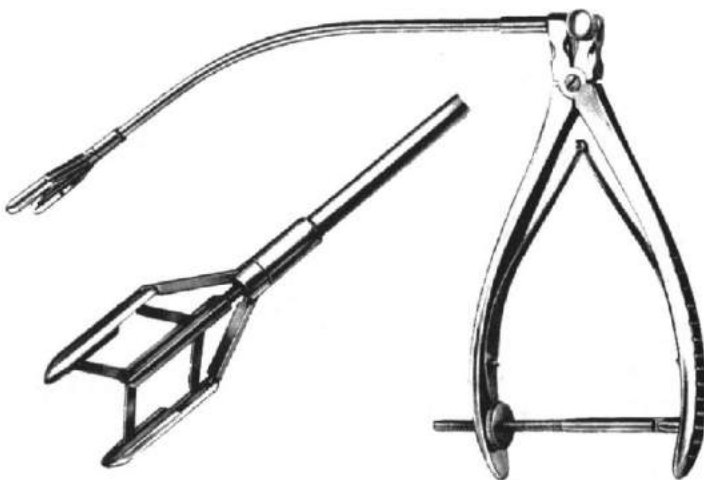

COOLEY  
66-506-00



RUMEL-BELMONT  
66-700-33 3.2 mm Ø  
66-710-33 6.4 mm Ø  
33 cm, 13"  
Flexible,  
flexible, flessibile

66-700-01  
66-710-01  
Guide Only  
Guida sola





## Vascular Dilators Dilatadores vasculares

GARRET Dilator Set of 9, 8"  
66-805-00

Malleable  
maleables  
malleabili

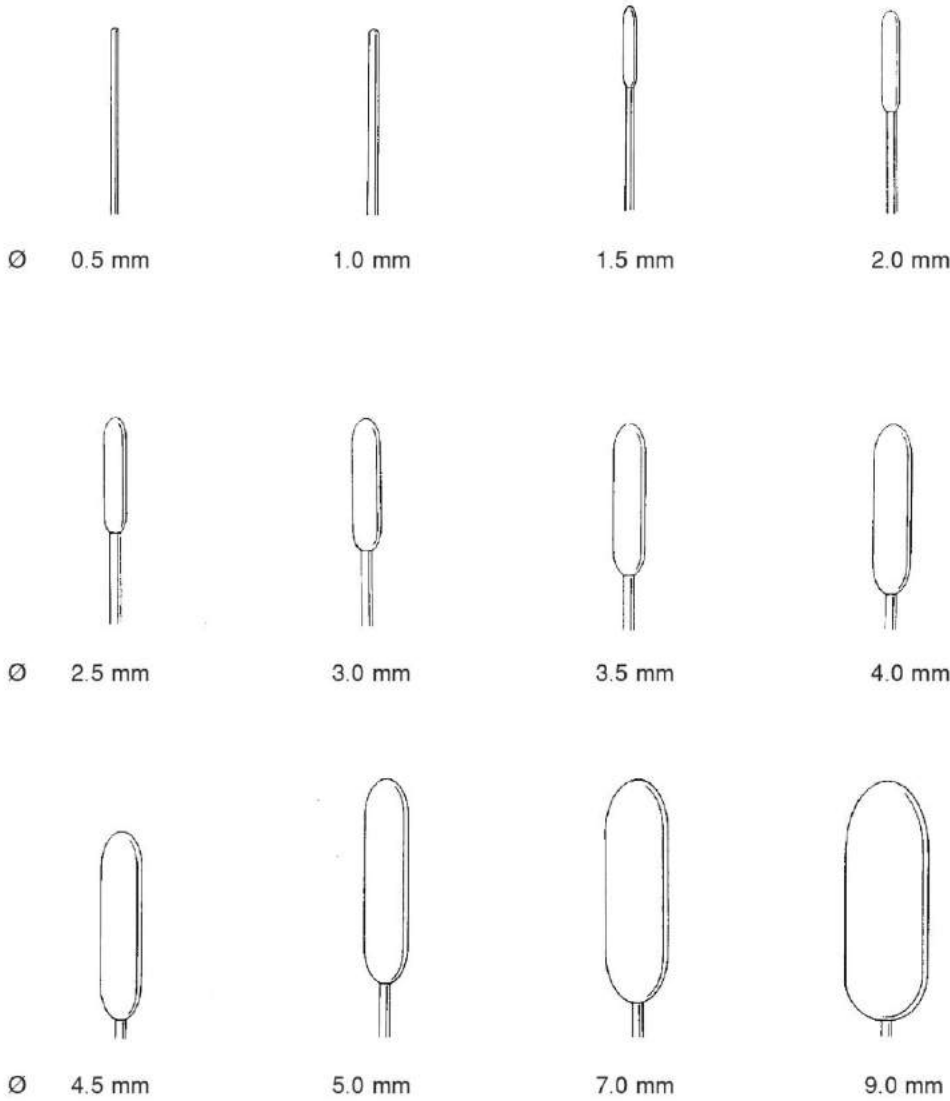

DE BAKEY

19 cm, 7 1/2"	Ø mm	35 cm, 13 3/4"
66-810-05	0.5	66-820-05
66-810-10	1.0	66-820-10
66-810-15	1.5	66-820-15
66-810-20	2.0	66-820-20
66-810-25	2.5	66-820-25
66-810-30	3.0	66-820-30
66-810-35	3.5	66-820-35
66-810-40	4.0	66-820-40
66-810-45	4.5	66-820-45
66-810-50	5.0	66-820-50
66-810-70	7.0	66-820-70
66-810-90	9.0	66-820-90



Spatulas  
Espátulas

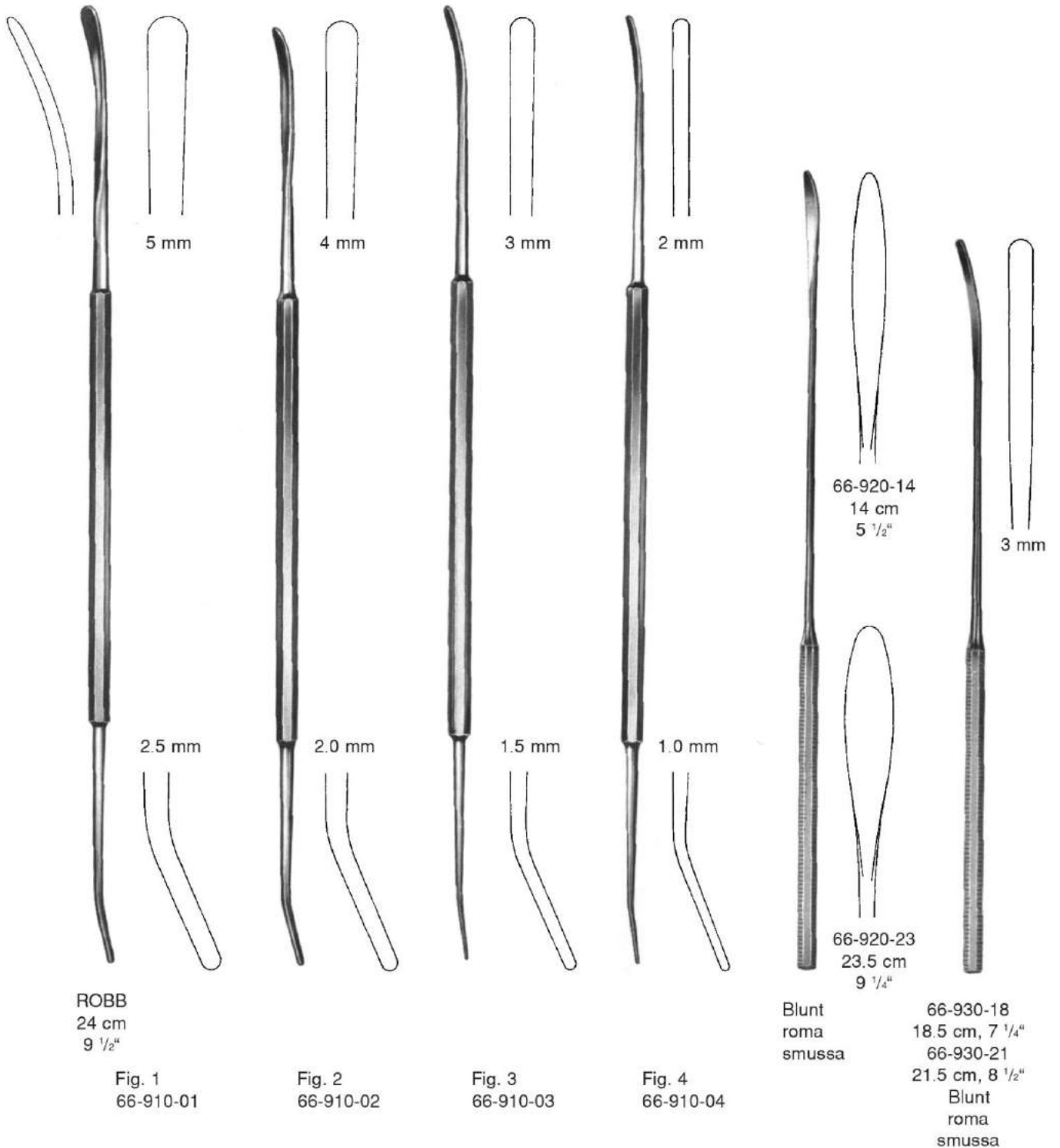



Gall Stone Forceps  
Pinzas para cálculos biliares



Fig. 1  
68-101-23

Fig. 2  
68-103-23

**DESJARDINS**  
23 cm, 9"

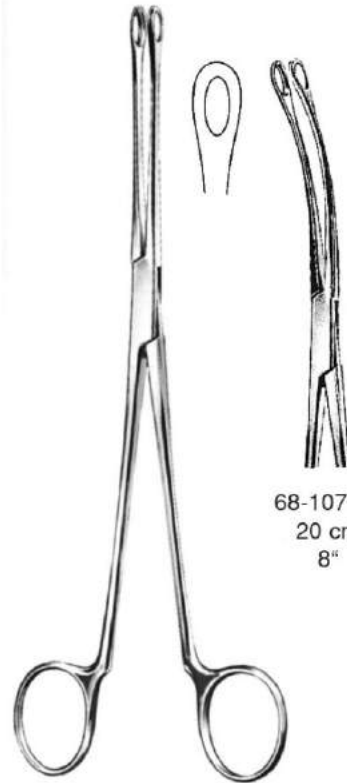

68-107-20  
20 cm  
8"

**BLAKE**  
68-106-20 20 cm, 8"



**MAYO-BLAKE**  
68-110-20 20 cm, 8"



**MAYO-BLAKE**  
68-111-20 20 cm, 8"



**MIXTER**  
68-117-22 22 cm, 8 3/4"



Gall Stone Probes, Bile Duct Dilators  
 Exploradores para cálculos biliares, Dilatadores para conductos biliares



MOOR  
 68-125-28  
 Ø 5.8 cm

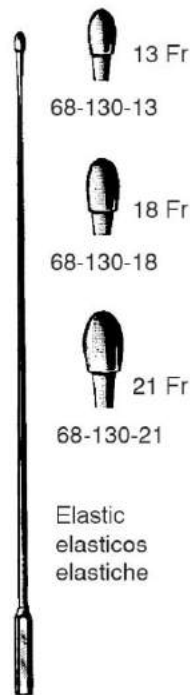

DESJARDINS  
 68-130-13 to 68-130-21  
 28 cm, 11"

13 Fr  
 68-130-13  
 18 Fr  
 68-130-18  
 21 Fr  
 68-130-21

Elastic  
 elasticos  
 elastiche

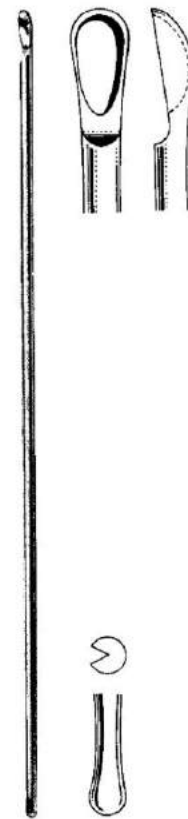

MOYNIHAN  
 68-142-34 34 cm, 13.4"



BAKES  
 68-150-01 to 68-150-13  
 30 cm, 11 3/4"

Ø mm 1  
 68-150-01

2  
 -02

3  
 -03

4  
 -04

5  
 -05

6  
 -06

7  
 -07

Ø mm 8  
 68-150-08

9  
 -09

10  
 -10

11  
 -11

12  
 -12

13  
 -13

Malleable  
 maleable  
 malleabili

68-150-00 Set of 9 in Case Sizes 3 to 11  
 juego de 9 en estuche fig. 3-11 / serie di 9 pezzi in astuccio



Gall Stone Scoops  
Cucharillas para cálculos biliares

Malleable  
maleables  
malleabili



**LUER-KOERTE**  
68-173-01 to 68-173-08  
32 cm, 12 3/4"



**FERGUSSON**  
68-170-21 to 68-170-23



68-170-21  
21.5 cm  
8 1/2"



68-170-22  
22 cm  
8 3/4"

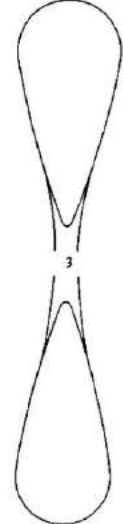

68-170-23  
23.5 cm  
9 1/4"



Fig. 000  
68-173-01

2.5 mm



Fig. 00  
68-173-02

3.2 mm



Fig. 0  
68-173-03

3.6 mm



Fig. 1  
68-173-04

5.5 mm



Fig. 2  
68-173-05

6.7 mm



Fig. 3  
68-173-06

8.0 mm



Fig. 4  
68-173-07

11 mm



Fig. 5  
68-173-08

15 mm



Gall Stone Scoops, Probe  
Cucharillas para cálculos biliares



MAYO  
68-175-27  
27 cm, 10 1/2"



68-178-01  
Small, pequeña, piccola

68-178-03  
Large, grande

MAYO  
68-178-01 68-178-03  
27 cm, 10 1/2"



17 Fr  
Fig. 1  
68-180-17

21 Fr  
Fig. 2  
68-180-21

24 Fr  
Fig. 3  
68-180-24

27 Fr  
Fig. 4  
68-180-27

Elastic  
elásticas  
elastiche

DESJARDINS  
68-180-17 to 68-180-27



MAYO  
68-210-32 32 cm, 12 3/4"



Kidney Stone Forceps  
Pinzas para cálculos renales



**RANDALL**

- Fig. 1 68-231-01 23 cm, 9"
- Fig. 2 68-231-02 22 cm, 8 <sup>3</sup>/<sub>4</sub>"
- Fig. 3 68-231-03 22 cm, 8 <sup>3</sup>/<sub>4</sub>"
- Fig. 4 68-231-04 22 cm, 8 <sup>3</sup>/<sub>4</sub>"
- Fig. 5 68-231-05 19 cm, 7 <sup>1</sup>/<sub>2</sub>"
- Fig. 6 68-231-06 19 cm, 7 <sup>1</sup>/<sub>2</sub>"

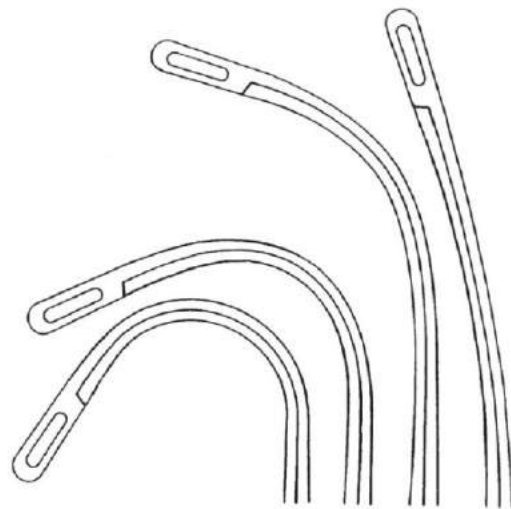

Fig. 4 Fig. 3 Fig. 2 Fig. 1

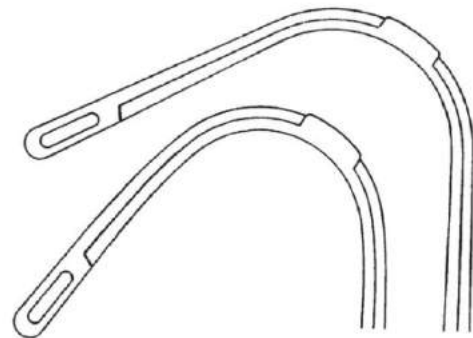

Fig. 6 Fig. 5







Intestinal Forceps  
Pinzas para coger intestinos y tejidos



**BABY-ALLIS**  
72-102-12 12 cm, 4 3/4"  
72-102-14 14 cm, 5 1/2"

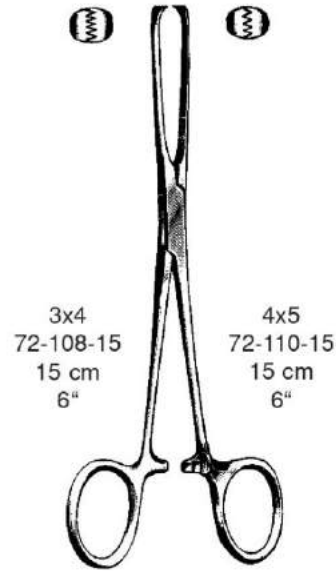

**ALLIS**  
15 cm 6" 72-120-15  
19 cm 7 1/2" 72-120-19  
22 cm 8 3/4" 72-120-22  
24 cm 9 1/2" 72-120-24

72-122-24  
Right Angle

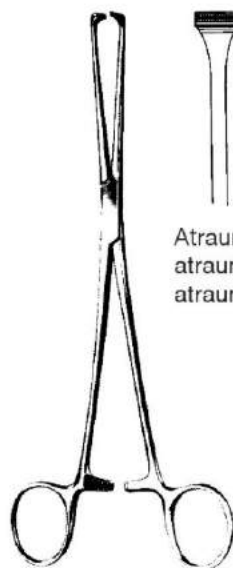

**ALLIS**  
72-124-16 16 cm, 6 1/4"  
72-124-20 20 cm, 8"  
72-124-25 25 cm, 10"  
72-124-30 30 cm, 11 3/4"

Atraumatic  
atraumática  
atraumatica

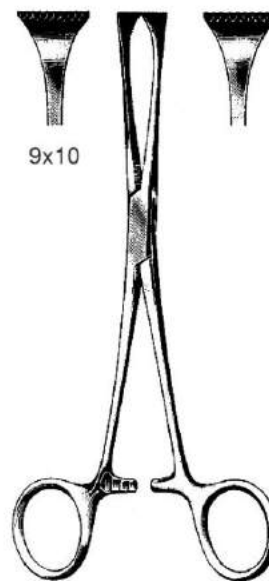

**ALLIS-ADAIR**  
72-130-15  
15.5 cm, 6.1"



Intestinal Forceps  
Pinzas para coger intestinos y tejidos

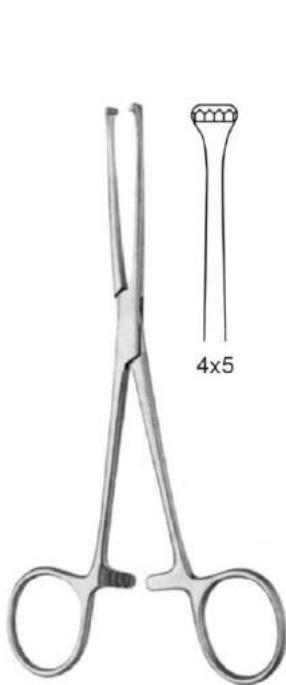

**LOCKWOOD-ALLIS**  
72-132-16 16 cm, 6 1/4"  
72-132-20 20 cm, 8"

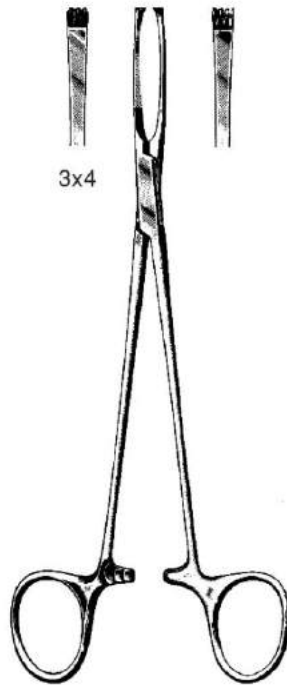

**JUDD-ALLIS**  
72-140-15 15 cm, 6"  
72-140-19 19 cm, 7 1/2"



**BOYS-ALLIS**  
72-145-15 15 cm, 6"

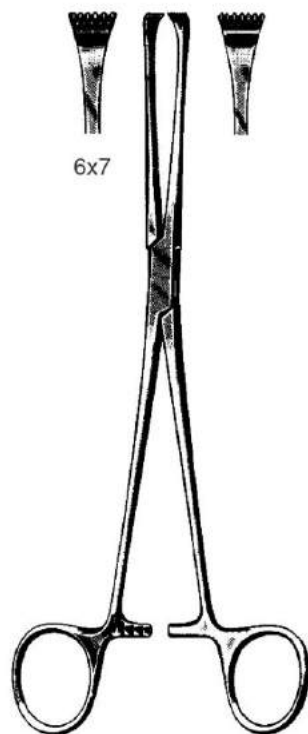

**THOMS-ALLIS**  
72-150-20 20 cm, 8"



**LITTLEWOOD**  
72-154-18 18.5 cm, 7 1/4"



**Intestinal Forceps**  
**Pinzas para coger tejidos e intestinos**



Atraumatic  
 atraumática  
 atraumatica

72-168-16 16 cm, 6 1/4"  
 72-168-20 20 cm, 8"

**BABCOCK**

72-160-16 16 cm **72-160-16 TC 16 cm**  
 72-160-18 18 cm **72-160-20 TC 20 cm**  
 72-160-20 20 cm  
 72-160-24 24 cm

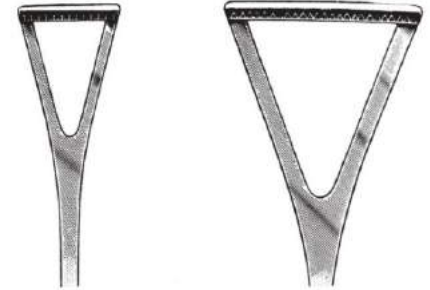

13 mm	cm	25 mm
72-170-18	18 7"	
72-170-20	20 8"	72-172-20
<b>72-170-20 TC</b>	20 8"	
	23 9"	72-172-23

**DUVAL**

72-170-18 to 72-172-23

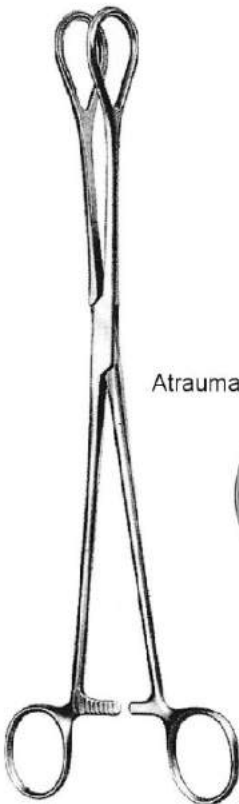

Atraumatic

18-377-25  
 25 cm, 10"

18-377-26  
 26 cm, 10 1/4"

**FOERESTER**

18-377-25 18-377-26



72-178-19  
 19 cm  
 7 1/2"

72-178-23  
 23 cm  
 9"

**COLLIN**



**WILLIAMS**

72-180-16 16.5 cm, 6 1/2"



## Intestinal Forceps Pinzas intestinales

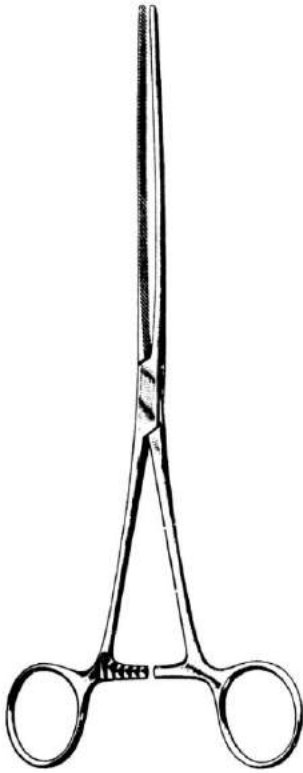

**DOYEN**  
72-210-18 to 72-217-23

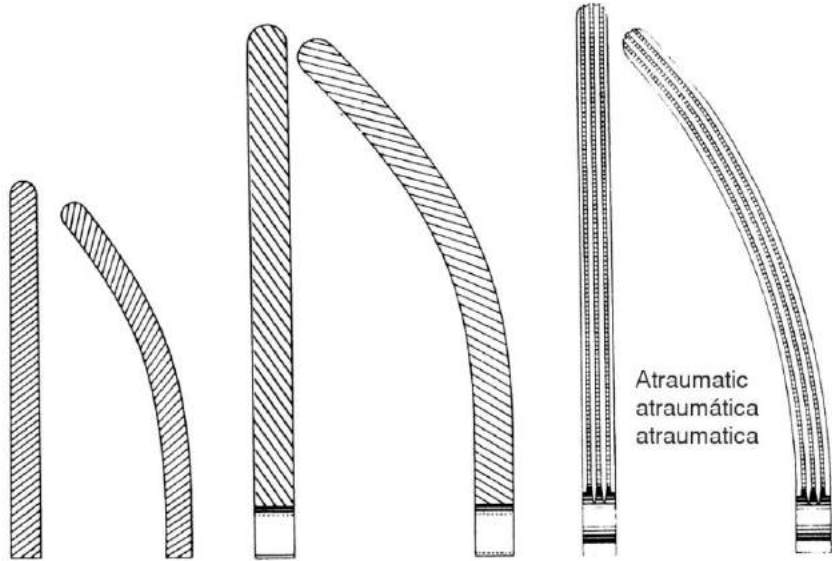

**BABY - DOYEN**  
72-210-18 72-211-18  
18 cm, 7"

**DOYEN**  
72-210-21 21 cm 72-211-21  
72-210-23 23 cm 72-211-23

**DOYEN**  
72-216-13 13 cm 72-217-13  
72-216-16 16 cm 72-217-16  
72-216-18 18 cm 72-217-18  
72-216-21 21 cm 72-217-21  
72-216-23 23 cm 72-217-23

Atraumatic  
atraumática  
atraumatica

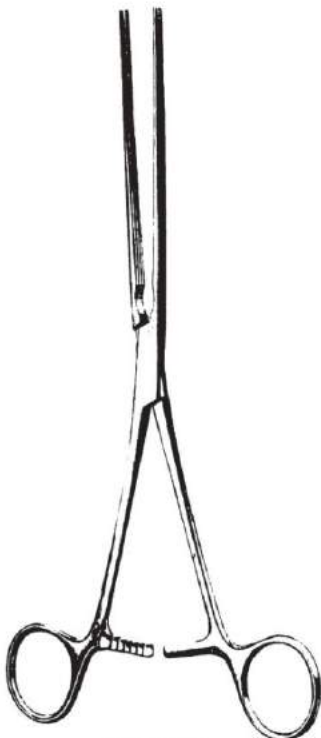

**KOCHER**  
72-220-22 to 72-227-28

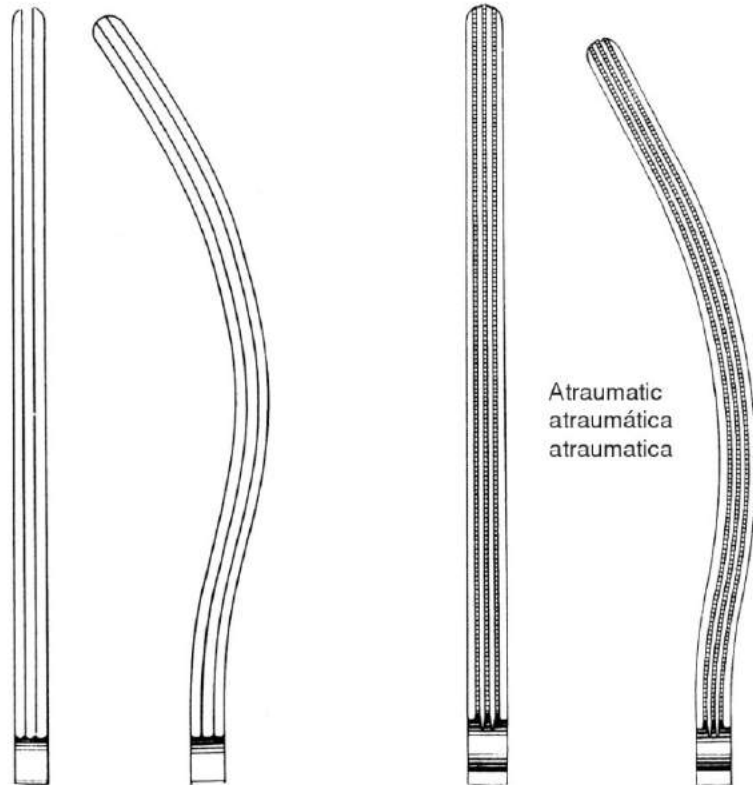

72-220-13 13 cm 72-221-13 (BABY-KOCHER)  
72-220-22 22 cm 72-221-22  
72-220-25 25 cm 72-221-25  
72-220-28 28 cm 72-221-28

72-226-22 22 cm 72-227-22  
72-226-25 25 cm 72-227-25  
72-226-28 28 cm 72-227-28

Atraumatic  
atraumática  
atraumatica



Intestinal Forceps  
Pinzas intestinales

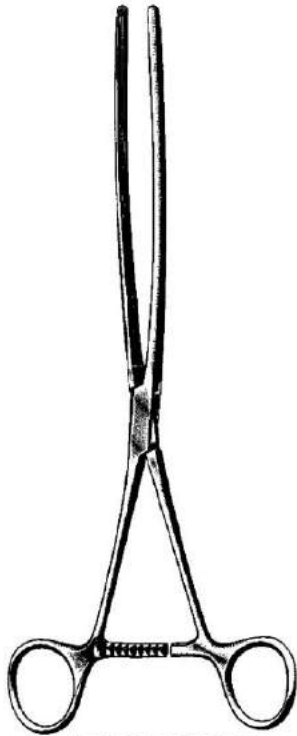

**MAYO-ROBSON**  
72-230-21 to 72-237-25  
21 to 25 cm  
8 1/4" to 10"

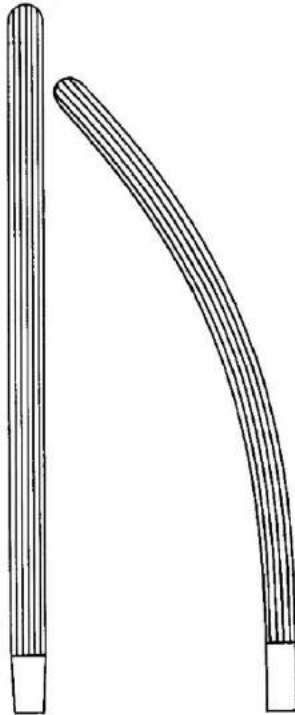

72-230-21  
72-230-23  
72-230-25

72-231-21  
72-231-23  
72-231-25

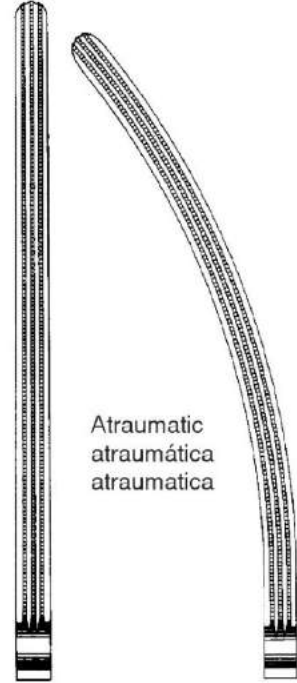

Atraumatic  
atraumática  
atraumatica

72-236-25

72-237-25



**SCUDDER**  
72-238-33  
33 cm  
13"

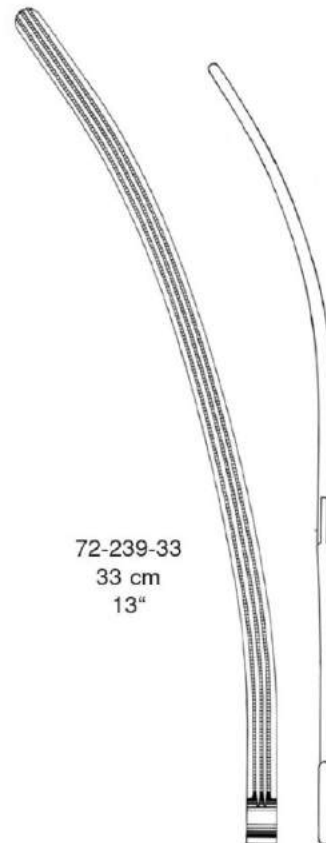

72-239-33  
33 cm  
13"

Intestinal Forceps  
Pinzas intestinales

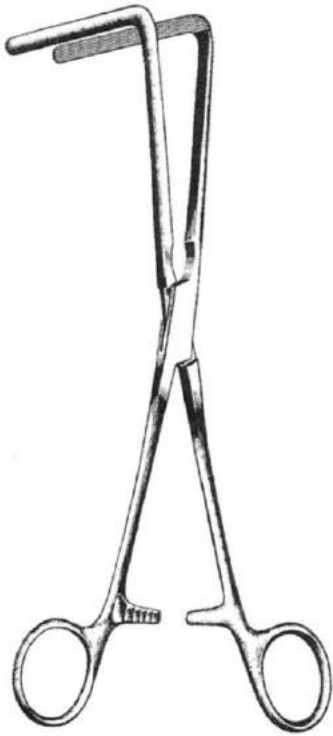

FEHLAND  
72-241-23  
23.5 cm 9 1/4"



RESANO  
72-242-30  
30 cm, 11 3/4"



Intestinal and Stomach Clamps  
Pinzas-clamps intestinales y estomacales

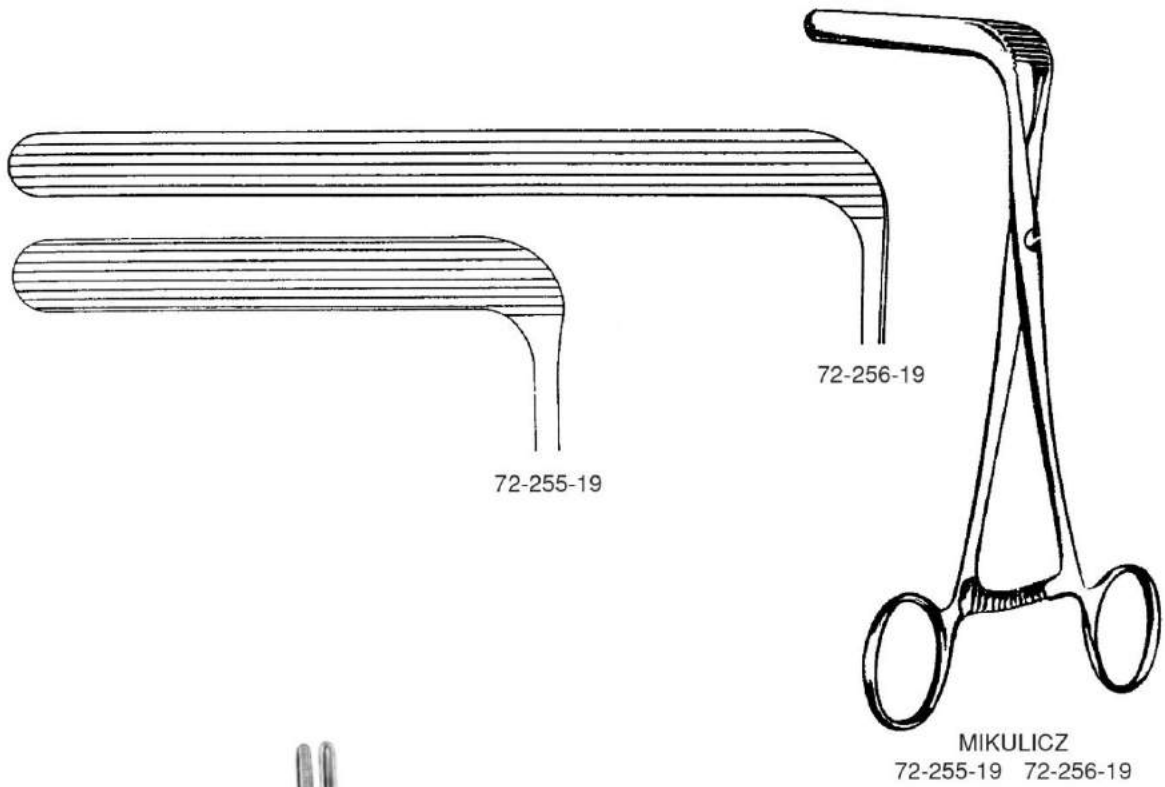

**BRUNNER**  
72-259-24 24 cm, 9 1/2"

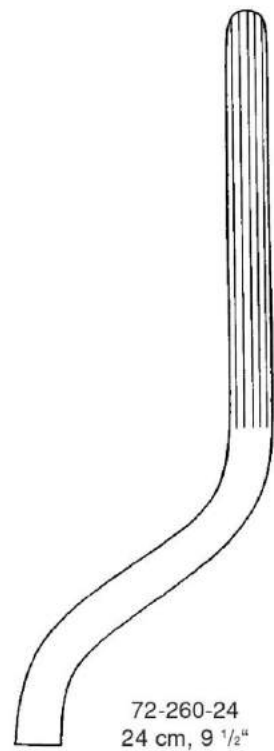
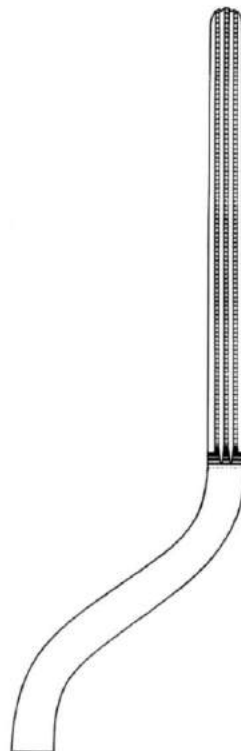

72-260-24  
24 cm, 9 1/2"



Pylorus Spreader, Intestinal Clamps  
Separador para pílono, Pinzas para apéndice



BENSON  
72-261-15  
15.5 cm, 6"

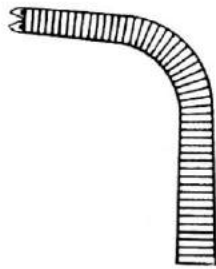

KLEINSCHMIDT  
72-262-12  
12 cm, 4 3/4"

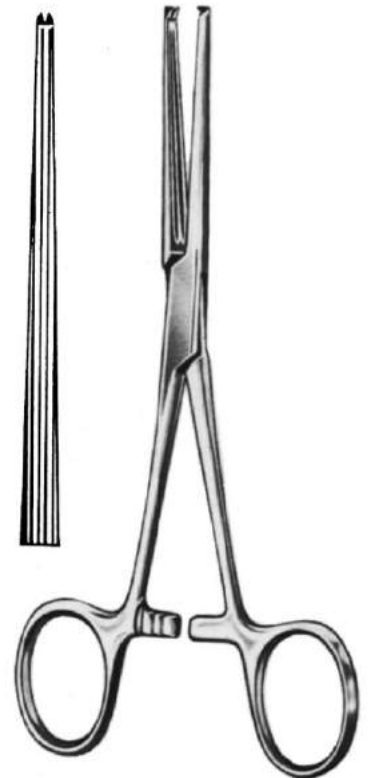

ALLEN  
72-263-15  
15 cm, 6"  
72-263-20  
20 cm, 8"





Atraumatic Sigmoid Anastomosis Forceps, Anastomosis Clamp Forceps  
Pinzas para anastomosis del recto atraumáticas, Pinzas clamps para anastomosis



HAYES  
72-265-26 26 cm, 10 1/4"  
72-265-28 28 cm, 11"

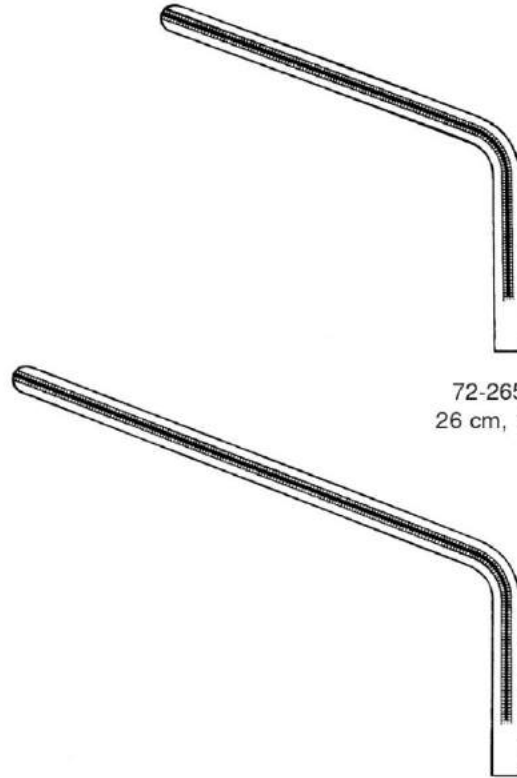

72-265-26  
26 cm, 10 1/4"

72-265-28  
28 cm, 11"

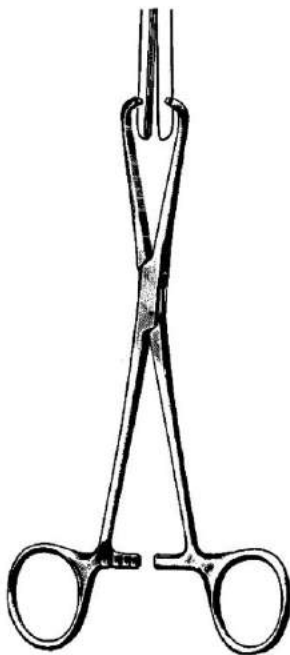

STONE  
72-270-15  
15.5 cm, 6.1"



STONE-WATT  
72-272-07 7.5 cm, 3"  
72-272-10 10.0 cm, 4"



STONE-WATT  
72-274-00  
Locking Clamp



Anastomosis Clamp Forceps, Clamp Closing Forceps, Clamp Holders  
 Pinzas-clamps para anastomosis, Pinzas para cerrar clamps, Porta-clamps



DE MARTEL-WOLFSON  
 72-280-05 5 cm, 2" Set of 3  
 72-280-07 7 cm, 2 3/4" Set of 3  
 72-280-10 10 cm, 4" Set of 3

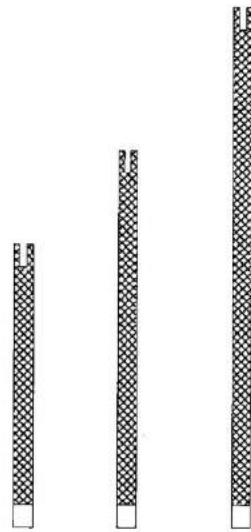

50 mm 70 mm 100 mm



DE MARTEL-WOLFSON  
 72-282-26 26 cm, 10 1/4"



DE MARTEL-WOLFSON  
 72-284-08 8.5 cm, 3.4"

DE MARTEL-WOLFSON  
 72-284-23 23 cm, 9"



Stomach Clamps  
Pinzas-clamps estomacales

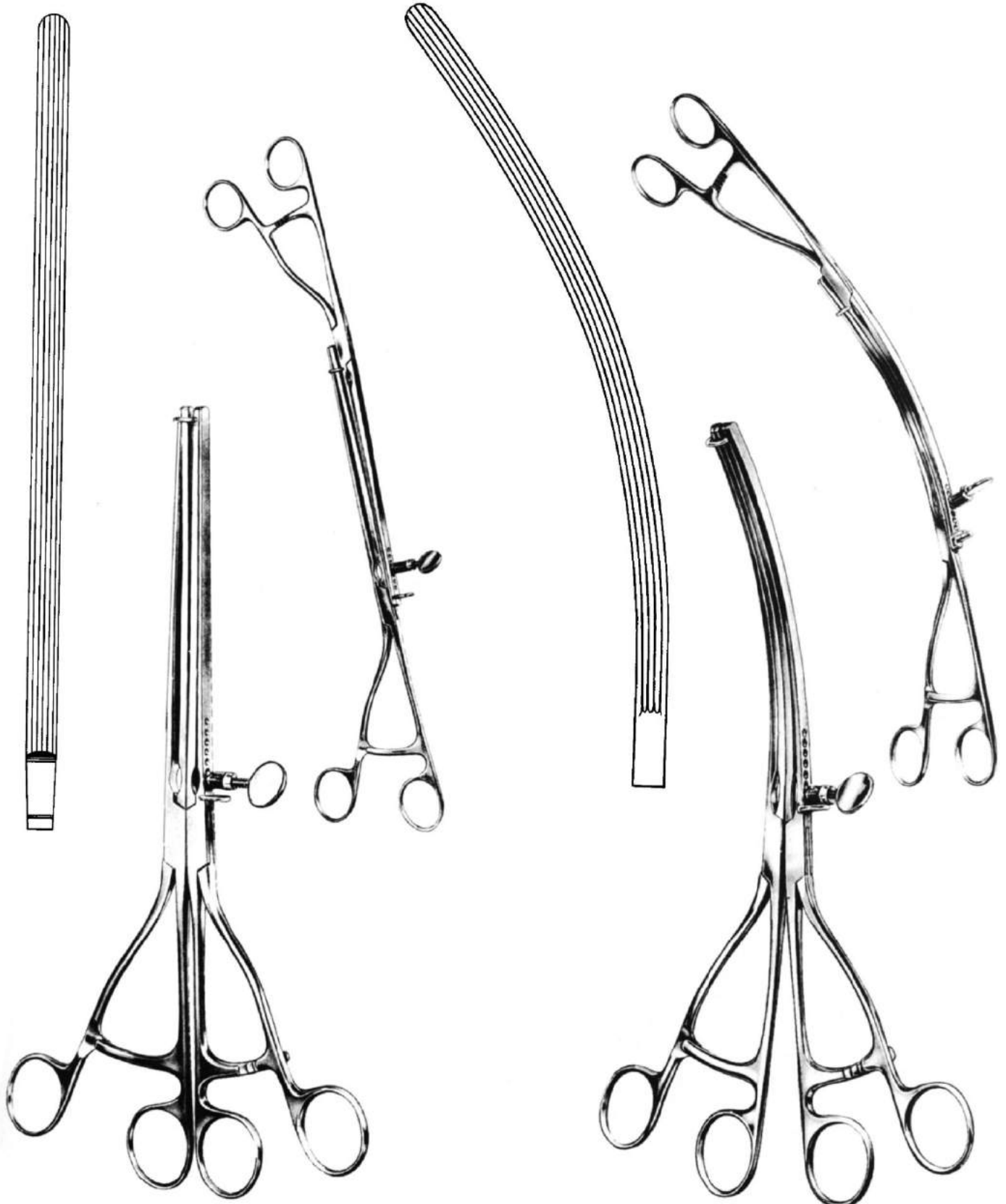

LANE  
72-290-30 30 cm, 11 3/4"

LANE  
72-291-30 30 cm, 11 3/4"



Intestinal and Stomach Clamps  
Pinzas-clamps intestinales y estomacales

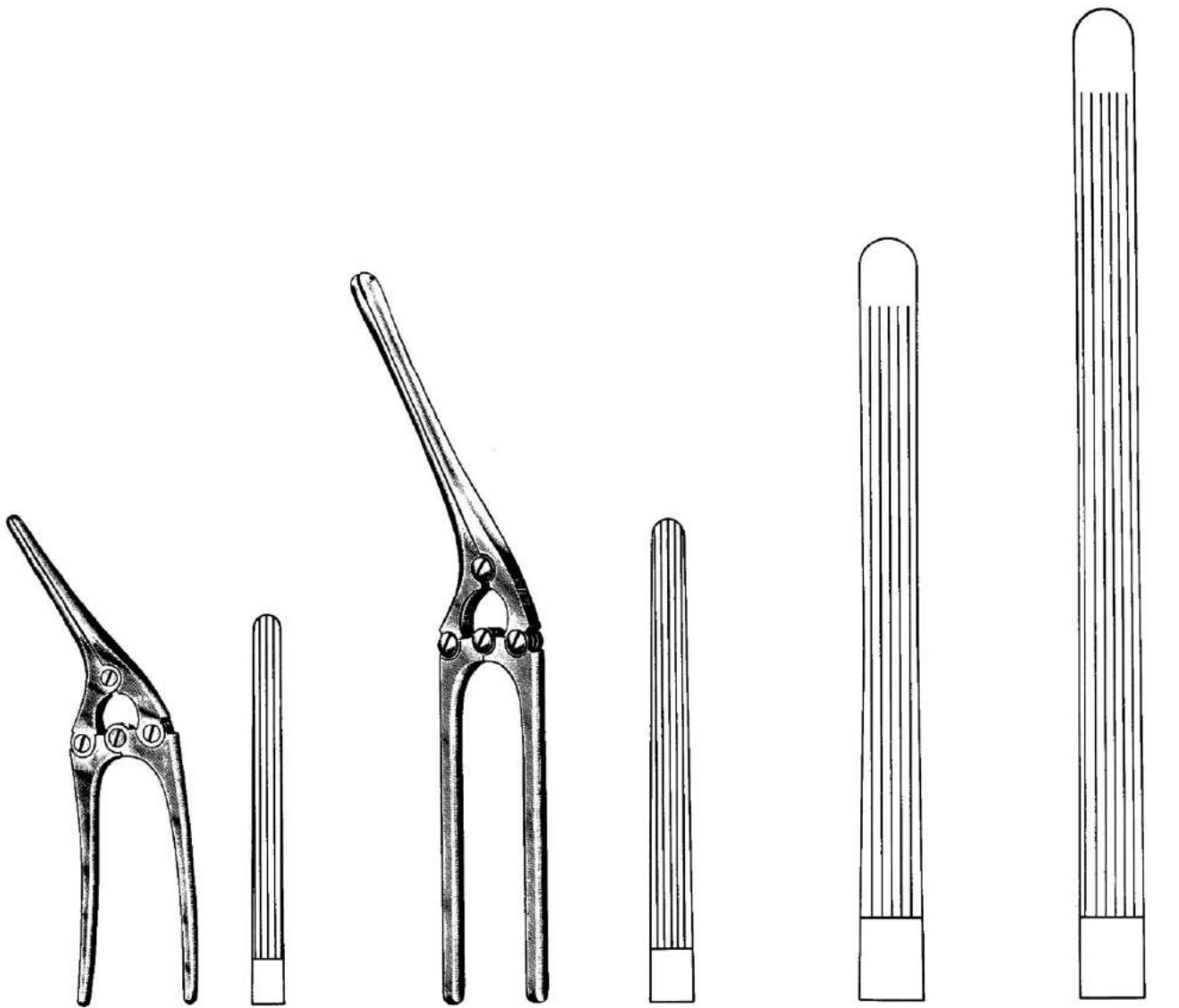

BABY-PAYR  
72-310-15  
15 cm, 6"

PAYR

72-310-21  
21 cm, 8 1/4"

72-310-29  
29 cm, 11.4"

72-310-35  
35 cm, 13.8"



## Stomach and Intestinal Suturing Apparatus Aparato para suturar estómago e intestinos

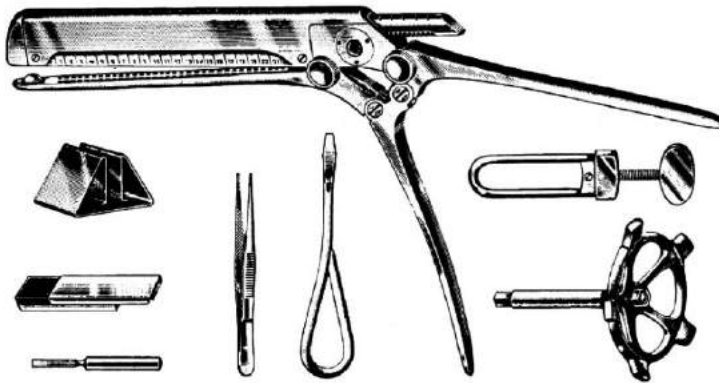

VON PETZ  
72-320-00

Complete in Wooden Case  
en estuche de madera  
in astuccio di legno



300 Each  
300 pzas.  
300 pezzi

72-321-0

Consisting of:

- Suturing Apparatus
- Wooden Case
- Additional Closing Clamp
- Gear Wheel
- Filling Rack
- Filling Pin
- Filling Tweezer
- Screw Driver
- Metal Box for Clips
- Silver Suturing Clips  
(Pkg of 300 ea.)

compuesto de:

- Aparator para suturar
- Estuche de madera
- Cierre adicional
- Manivela
- Soporte para rellenar
- Espiga para rellenar
- Pinza para rellenar
- Destornillador
- Estuche para agrafas
- Agrafas para sutura de plata  
(Paquete de 300 pzas.)

composta da:

- apparecchio per la sutura
- astuccio in legno
- Serratura supplementare
- manovella
- supporto di riempimento agraiffe
- perno per posizionare le agraiffe
- pinza per caricare
- cacciavite
- scatola in metallo per agraiffe
- agraiffe in argento  
(confezione da 300 pezz.)



Urological Retractors, Forceps  
Pinzas, Separadores Urologia

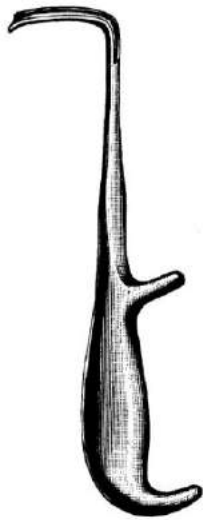

YOUNG  
74-101-21  
21 cm, 8 1/4"



YOUNG  
74-103-22  
22 cm, 8 3/4"



YOUNG  
74-105-21  
21 cm, 8 1/4"



YOUNG  
74-105-22  
22 cm, 8 3/4"

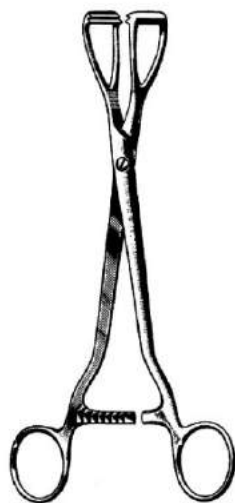

YOUNG  
74-106-20  
20 cm, 8"



MILLIN  
74-110-23



Urological Forceps  
Pinzas, Urologia

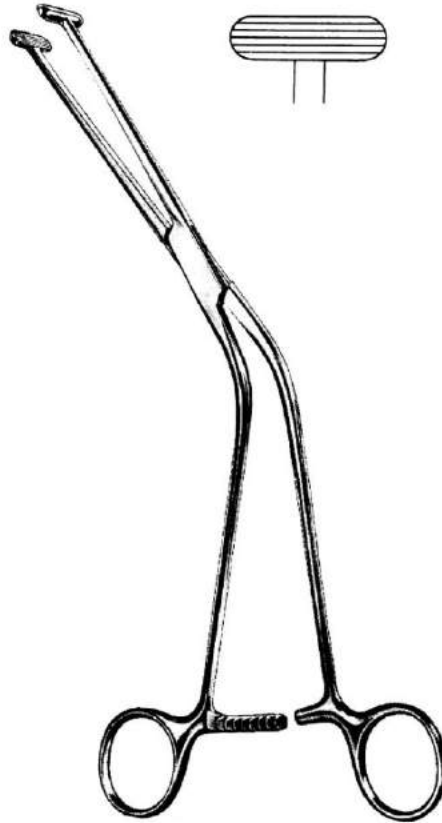

MILLIN  
74-111-23

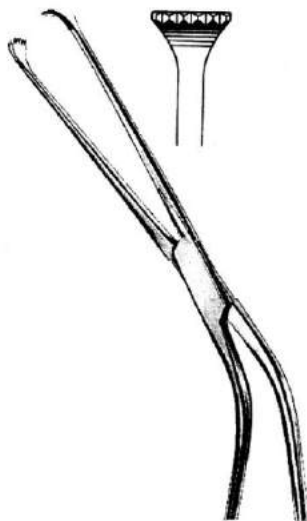

MILLIN  
74-123-23  
23 cm, 9"

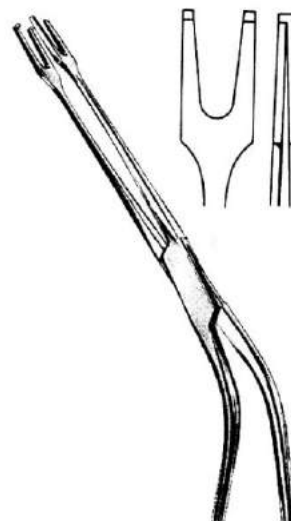

MILLIN  
74-125-24  
24 cm, 9 1/2"



## Prostatic Retractors, Bladder Retractors Separadores vesicales

74-130-01 2 Blades, valvas, valve  
74-130-02 2 Blades, valvas, valve  
74-130-03 1 Center Blade, valva

57 mm x 25 mm  
80 mm x 25 mm  
120 mm x 45 mm



LEGUEU  
74-147-27

KOCHER  
74-149-27



MILLIN  
74-130-00 Without Fiber Optic

74-132-00 Fiber Optic Light Carrier for  
74-130-00



JUDD-MASSON

74-150-00 With Central Blade  
con valva central, con valva centrale  
74-155-00 Without Central Blade  
sin valva central, senza valva centr.

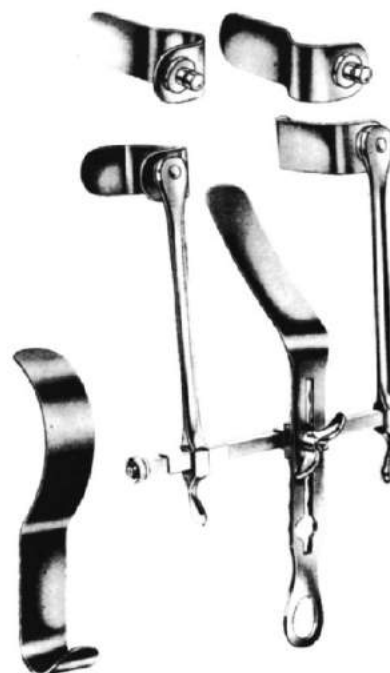

THOMSON-WALKER  
74-160-00





Bladder Retractor, Bladder Neck Spreader, Urethrotomes  
Separadores vesicales, Uretrótomos



LEGUEU  
74-163-00



MILLIN  
74-165-00

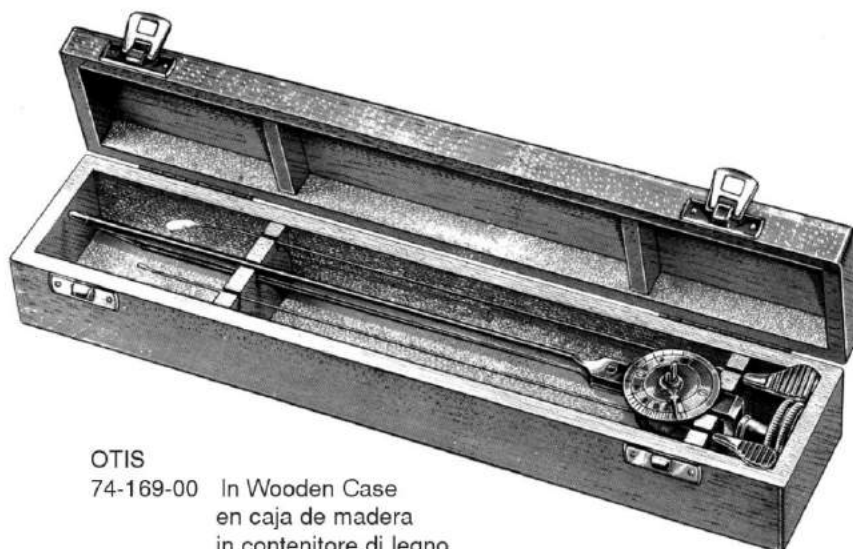

OTIS  
74-169-00 In Wooden Case  
en caja de madera  
in contenitore di legno

74-169-01 Blade Only  
Hoja de repuesto  
Lame di ricambio



## Catheter Introducer, Dilating Bougies Introducción de catéteres, Bujías dilatadoras

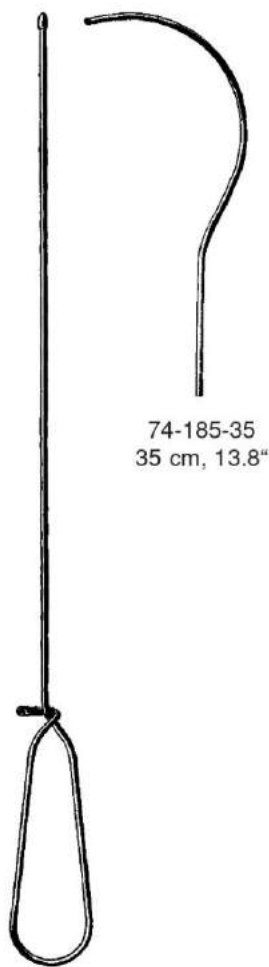

74-185-35  
35 cm, 13.8"

GUYON  
74-184-39  
39 cm, 15.4"



Fr	VAN BUREN	GUYON	28 cm, 11"	30 cm, 11 3/4"
8	74-201-08	74-205-08	74-206-08	74-207-08
9			74-206-09	74-207-09
10	74-201-10	74-205-10	74-206-10	74-207-10
11			74-206-11	74-207-11
12	74-201-12	74-205-12	74-206-12	74-207-12
13			74-206-13	74-207-13
14	74-201-14	74-205-14	74-206-14	74-207-14
15			74-206-15	74-207-15
16	74-201-16	74-205-16	74-206-16	74-207-16
17			74-206-17	74-207-17
18	74-201-18	74-205-18	74-206-18	74-207-18
19			74-206-19	74-207-19
20	74-201-20	74-205-20	74-206-20	74-207-20
21			74-206-21	74-207-21
22	74-201-22	74-205-22	74-206-22	74-207-22
23			74-206-23	74-207-23
24	74-201-24	74-205-24	74-206-24	74-207-24
25			74-206-25	74-207-25
26	74-201-26	74-205-26	74-206-26	74-207-26
27			74-206-27	74-207-27
28	74-201-28	74-205-28	74-206-28	74-207-28
29			74-206-29	74-207-29
30	74-201-30	74-205-30	74-206-30	74-207-30
32	74-201-32	74-205-32		
34	74-201-34	74-205-34		
36	74-202-36	74-205-36		
38		74-205-38		
40		74-205-40		

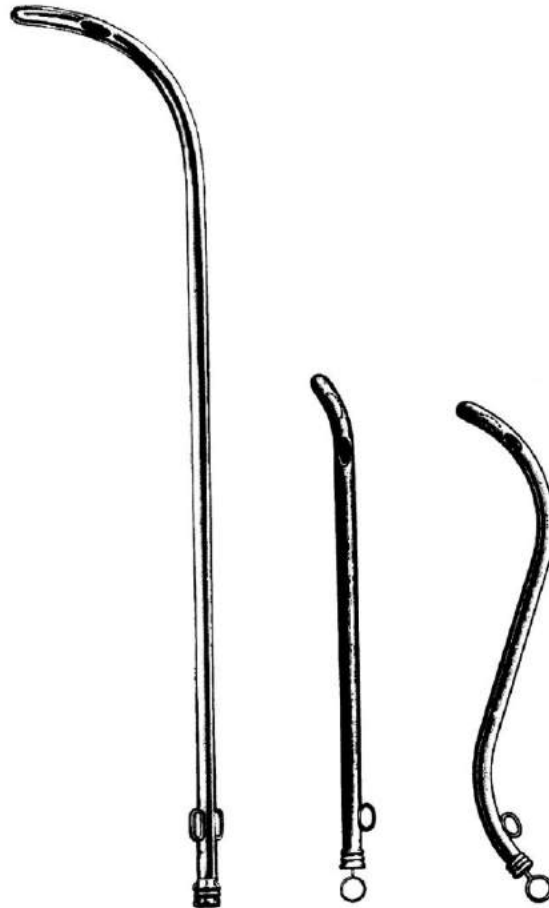

Charriere  
Fr

COXETER

6	74-211-06	74-213-06	
8	74-211-08	74-213-08	74-219-08
10	74-211-10	74-213-10	74-219-10
12	74-211-12	74-213-12	74-219-12
14	74-211-14	74-213-14	74-219-14
16	74-211-16	74-213-16	74-219-16
18	74-211-18	74-213-18	74-219-18
20	74-211-20	74-213-20	74-219-20
22	74-211-22	74-213-22	74-219-22
24	74-211-24	74-213-24	74-219-24



Foreign Body Forceps, Penile & Circumcision Instruments  
 Pinzas para cuerpos extraños, Compresores uretrales, Instrumentos para circuncisión

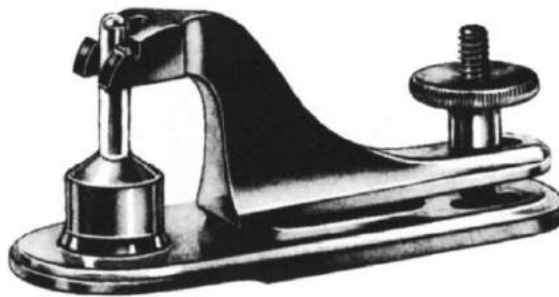

- 74-240-08 8 mm Ø
- 74-240-11 11 mm Ø
- 74-240-13 13 mm Ø
- 74-240-16 16 mm Ø
- 74-240-21 21 mm Ø
- 74-240-26 26 mm Ø
- 74-240-32 32 mm Ø

74-240-08 to 74-240-32



Circumcision Clamp  
 Instrumento para circuncisión  
 Strumento per circoncisione

- MOGEN**
- 74-250-07 7.5 cm, 3" 2.5 mm Adult
  - 74-251-07 7.5 cm, 3" 1.5 mm Child



- STOCKMAN**
- 74-175-08 8 cm, 3 1/8"



- STRAUSS**
- 74-177-11 11 cm, 4 3/8"

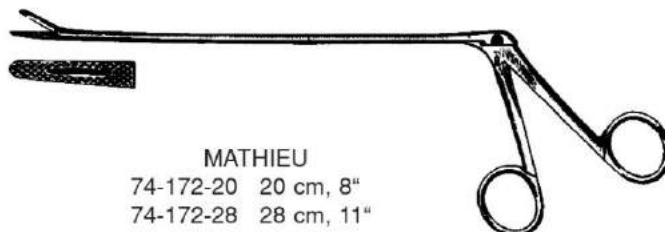

- MATHIEU**
- 74-172-20 20 cm, 8"
  - 74-172-28 28 cm, 11"

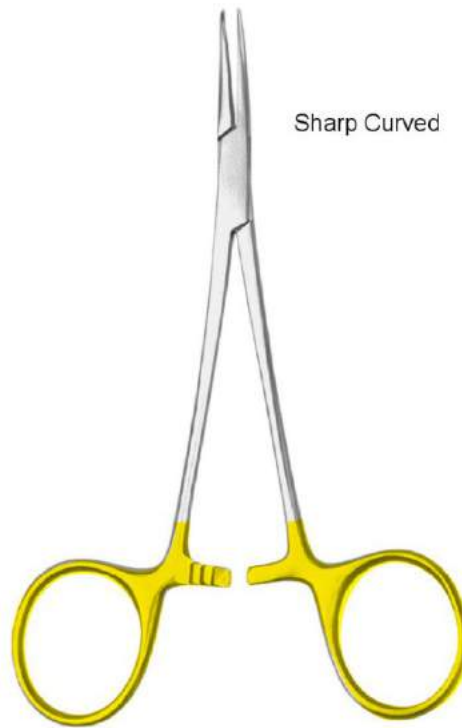

Sharp Curved

No Scalpel Vasectomy Clamp  
74-178-12

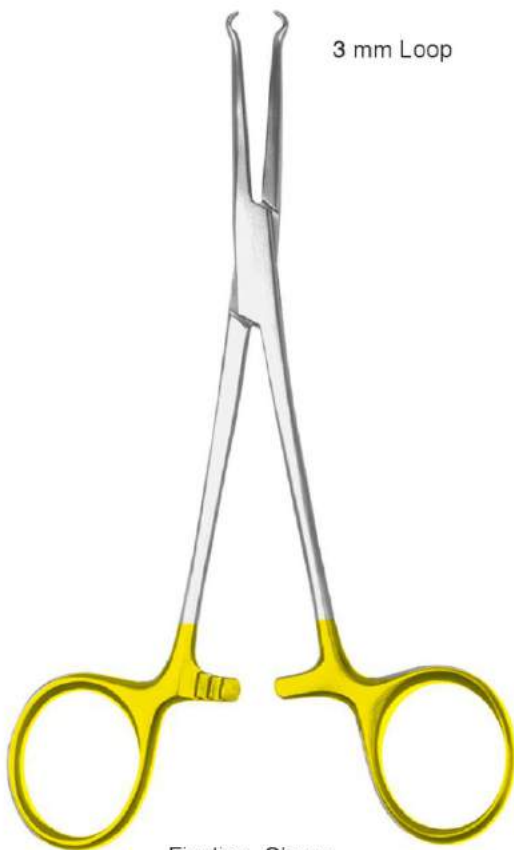

3 mm Loop

Fixation Clamp  
74-178-14



74-179-14  
14.5 cm, 5 3/4"





Rectal Specula  
Espéculos rectales



**CZERNY**  
76-105-22  
22 cm, 8 3/4"



**SIMS**  
76-110-15  
15 cm, 6"



**BODENHAMMER**  
76-115-15  
15 cm, 6"

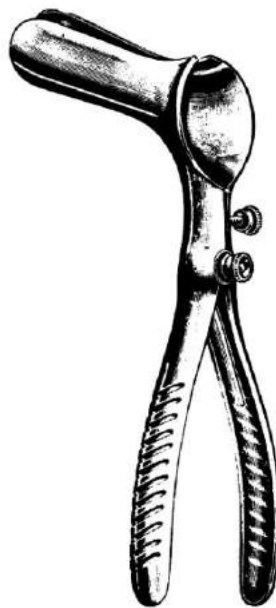

**PRATT**  
76-121-19  
19 cm, 7 1/2"



70 x 22 mm

**BARR**  
76-125-17  
17 cm, 6 3/4"



Rectal Specula  
Especúlos rectales



HILL-FERGUSON

- 76-126-01 6.4 x 2.2 cm 2 1/2" x 7/8"
- 76-126-02 7.6 x 3.0 cm 3" x 1 3/16"
- 76-126-03 7.6 x 3.6 cm 3" x 1 7/16"



SAWYER

- 76-127-01 6.4 x 2.2 cm 2 1/2" x 7/8"
- 76-127-02 7.6 x 2.9 cm 3" x 1 1/8"
- 76-127-03 8.9 x 3.8 cm 3 1/2" x 1 1/2"



MATHIEU

- 76-130-19
- 19.5 cm, 7 3/4"



SCHULZE-BERGMAN  
76-142-06 to 76-142-12

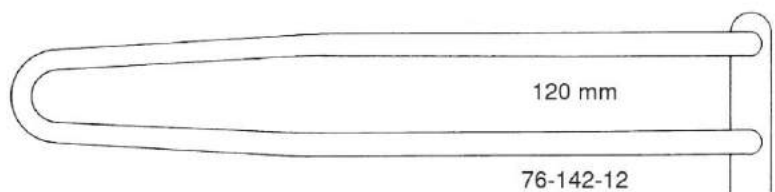
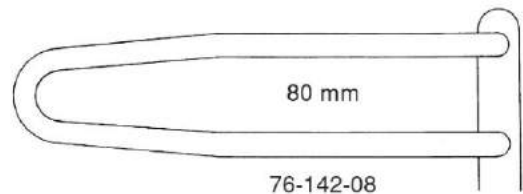
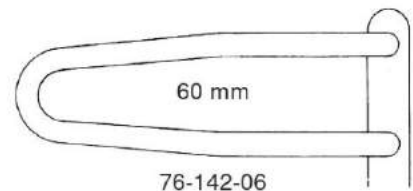





Anal Retractors  
Separadores rectales

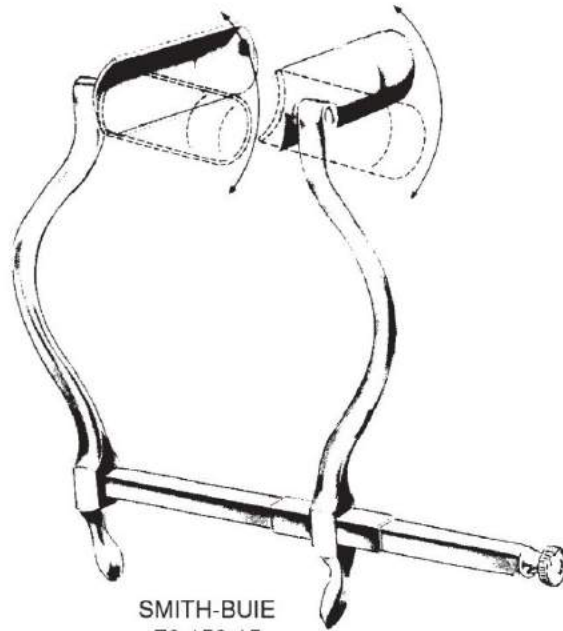

SMITH-BUIE  
76-150-15  
15 cm, 6"  
75 x 23 mm

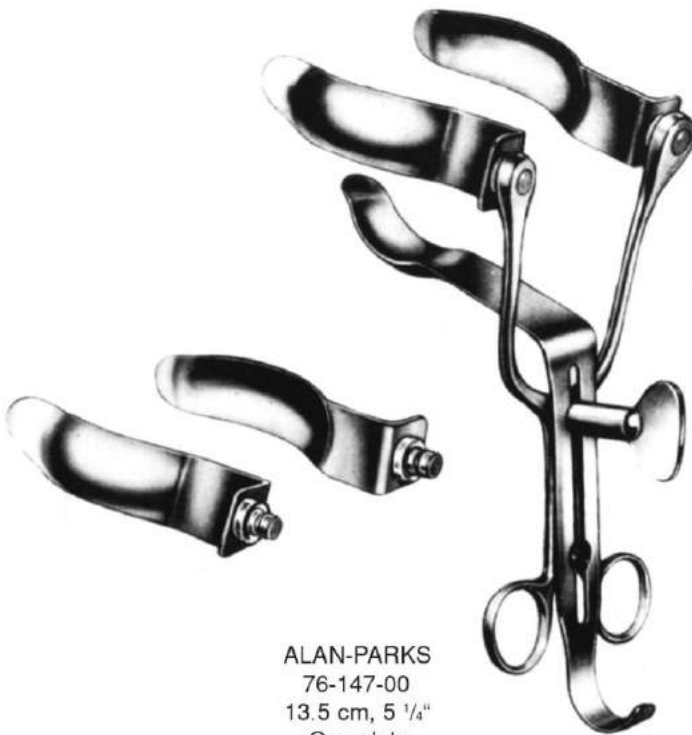

ALAN-PARKS  
76-147-00  
13.5 cm, 5 1/4"  
Complete

76-148-00  
Cold Light Attachment for 76-147-00  
Adaptador luz fría  
Adattatore luce fredda

76-147-02 Center Blade, Only  
Valva central, solo  
Valva centrale, solo

76-147-03 Blade Only 75 mm, 3"  
Valva solas  
Valva solo

76-147-04 Blade Only 95 mm, 3 3/4"  
Valva solas  
Valva solo

Proctoscopes  
Proctoscopios

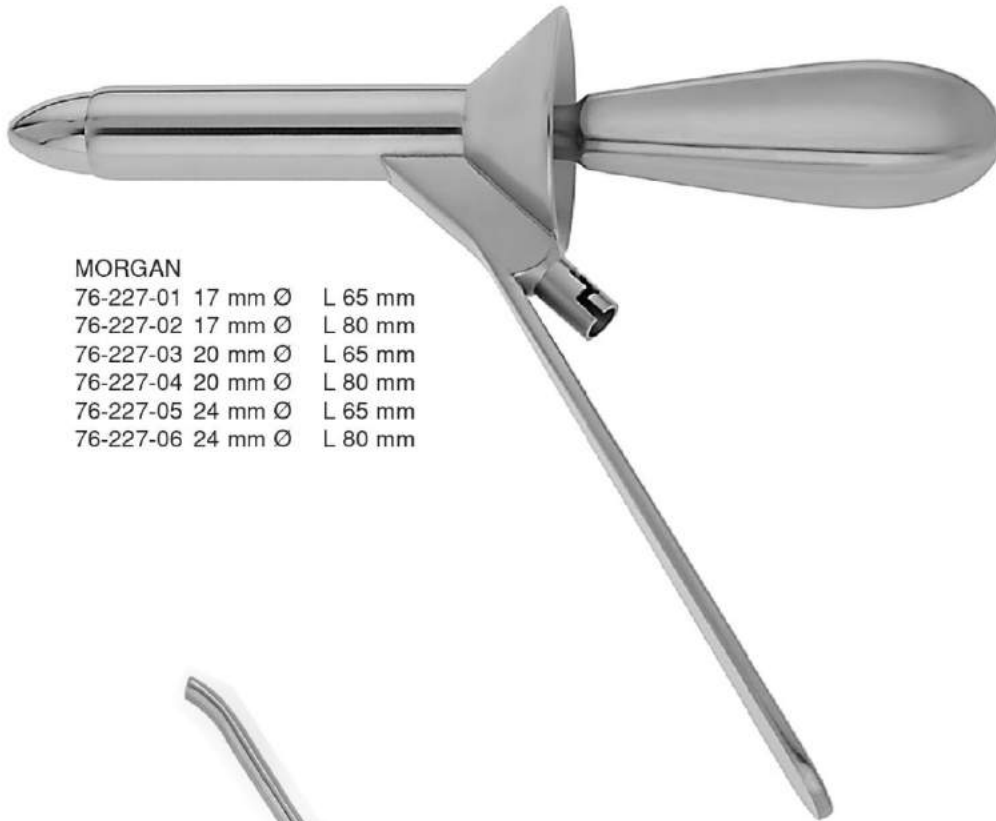

MORGAN

76-227-01	17 mm Ø	L 65 mm
76-227-02	17 mm Ø	L 80 mm
76-227-03	20 mm Ø	L 65 mm
76-227-04	20 mm Ø	L 80 mm
76-227-05	24 mm Ø	L 65 mm
76-227-06	24 mm Ø	L 80 mm



76-228-01

Illumination Attachment for Morgan  
Mango con iluminacion para Morgan  
Dispositivo Illuminativo per Morgan



Anoscopes, Proctoscopes  
Anoscopios, Proctoscopios



IVES-FANSLER  
76-210-22 22 mm Ø  
L 80 mm



Ø mm	HIRSCHMAN
16	76-212-16
19	76-212-19
22	76-212-22
	L 65 mm



mm	KELLY
Ø x L	76-220-05
22 x 50	76-220-10
22 x 100	76-220-14
22 x 140	76-220-20
22 x 200	



Anoscopes, Proctoscopes, Fistula Probe  
 Anoscopios, Proctoscopios, Sondas para fistulas



Ø mm KELLY  
 21 76-224-21  
 27 76-224-27  
 L 50 mm

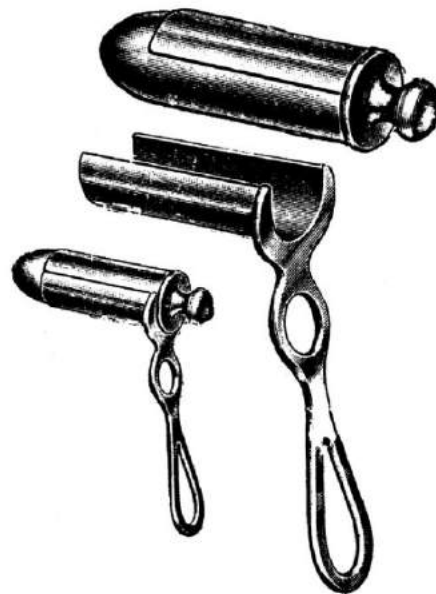

Ø mm x L CHELSEA-EATON  
 22 x 65 76-225-22  
 30 x 65 76-225-30

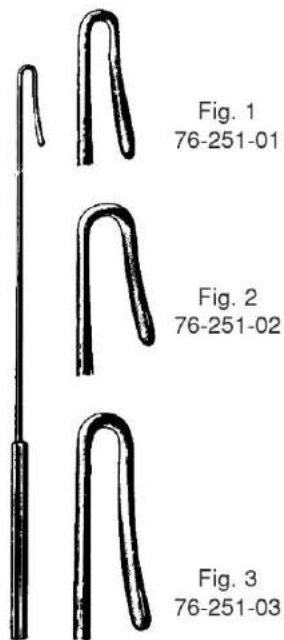
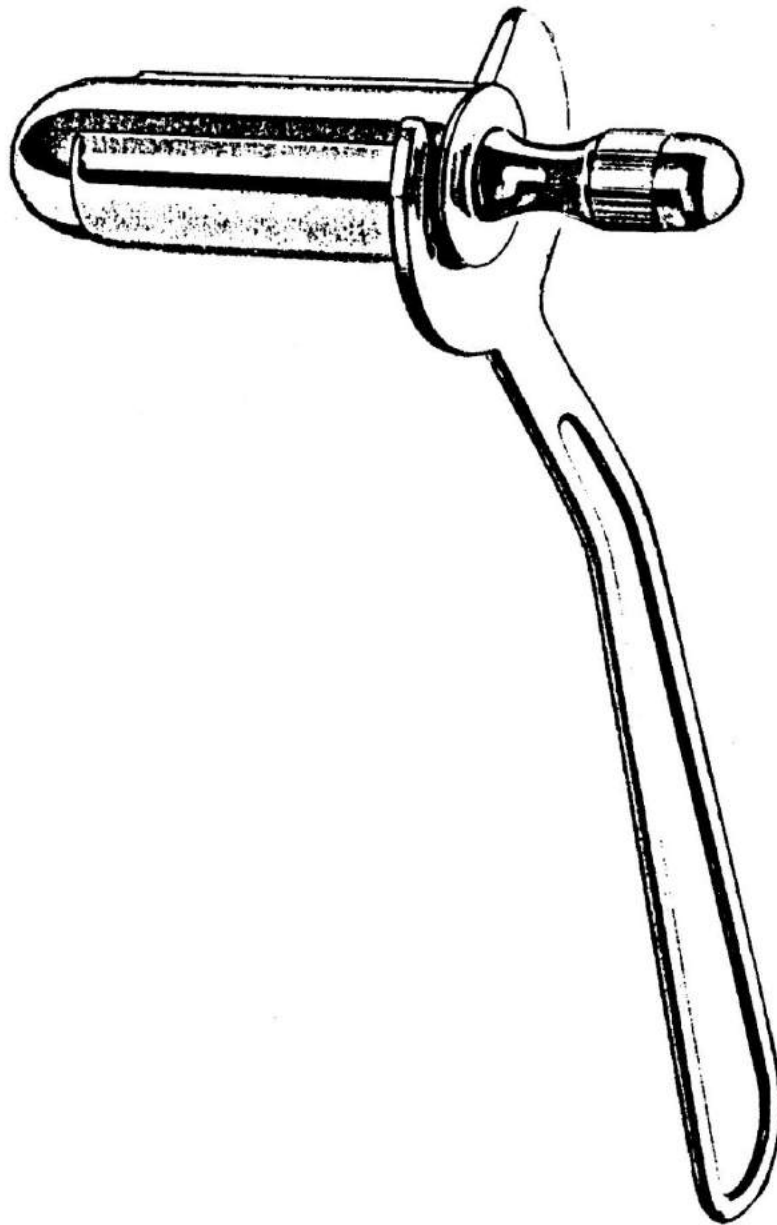

Fig. 1  
 76-251-01

Fig. 2  
 76-251-02

Fig. 3  
 76-251-03

PRATT  
 76-251-01 to 76-251-03



L x Ø	FANSLER
65 x 25 mm	76-226-25
65 x 29 mm	76-226-29
70 x 38 mm	76-226-38



Rectal Aspiration Cannula, Rectal Snare, Rectal Biopsy Specimen Forceps  
 Cánula de aspiración rectal, Cierra-nudo rectal, Pinzas para biopsia rectal



**BUIE**  
 76-261-41  
 41 cm, 16"

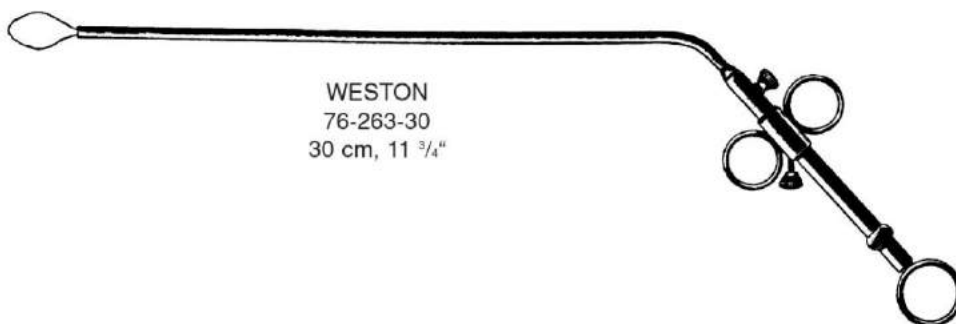

**WESTON**  
 76-263-30  
 30 cm, 11 3/4"

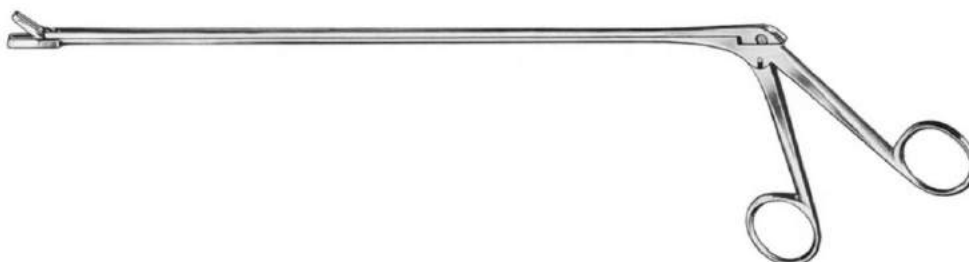

**YEOMAN**  
 76-301-28 to 76-304-42  
 28 cm, 11"  
 35 cm, 13.8"  
 42 cm, 16 1/2"

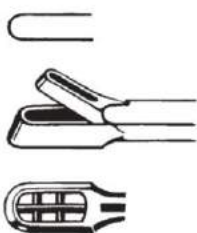

**Fig. 1**  
 76-301-28 28 cm, 11"  
 76-301-35 35 cm, 13.8"  
 76-301-42 42 cm, 16 1/2"

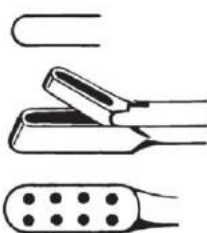

**Fig. 2**  
 76-302-28 28 cm, 11"  
 76-302-35 35 cm, 13.8"  
 76-302-42 42 cm, 16 1/2"

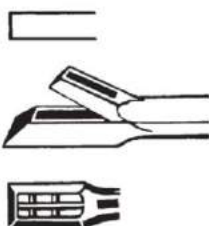

**Fig. 3**  
 76-303-28 28 cm, 11"  
 76-303-35 35 cm, 13.8"  
 76-303-42 42 cm, 16 1/2"

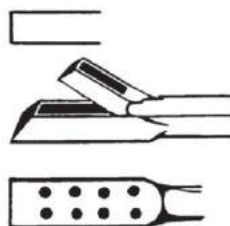

**Fig. 4**  
 76-304-28 28 cm, 11"  
 76-304-35 35 cm, 13.8"  
 76-304-42 42 cm, 16 1/2"



Rotating Rectal Biopsy Specimen Forceps, Hemorrhoidal Forceps  
Pinzas para biopsia rectal, giratoria, Pinzas-clamps hemorroidales

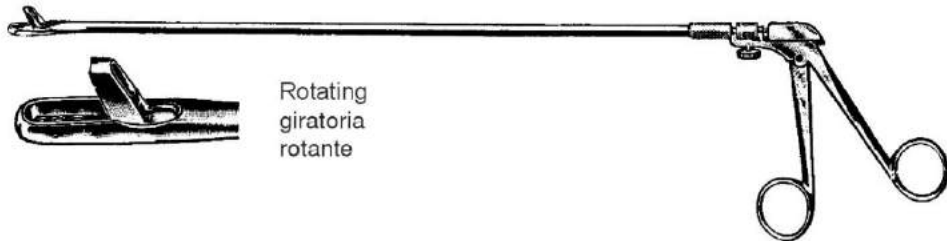

Rotating  
giratoria  
rotante

YEOMAN

76-311-23 23 cm, 9"  
76-311-33 33 cm, 13"  
76-311-40 40 cm, 15.4"

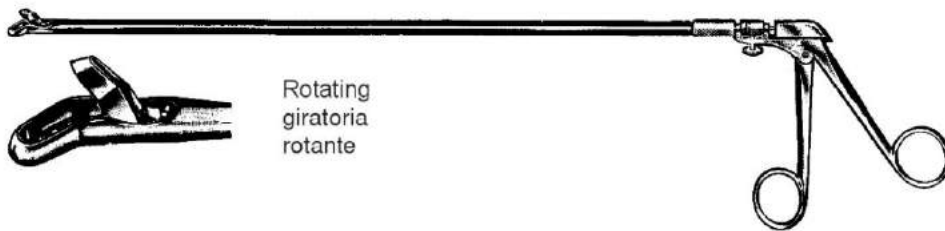

Rotating  
giratoria  
rotante

TURREL

76-321-23 23 cm, 9"  
76-321-33 33 cm, 13"  
76-321-40 40 cm, 15.4"

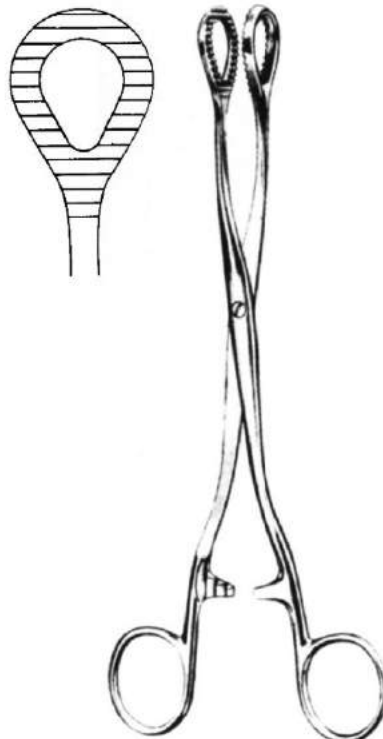

HEYWOOD-SMITH

76-402-21 21 cm, 8 1/4"  
76-402-25 25 cm, 10"



## Hemorrhoidal Ligators, Forceps Ligadores para hemorroides, Pinzas-clamps para hemorroides

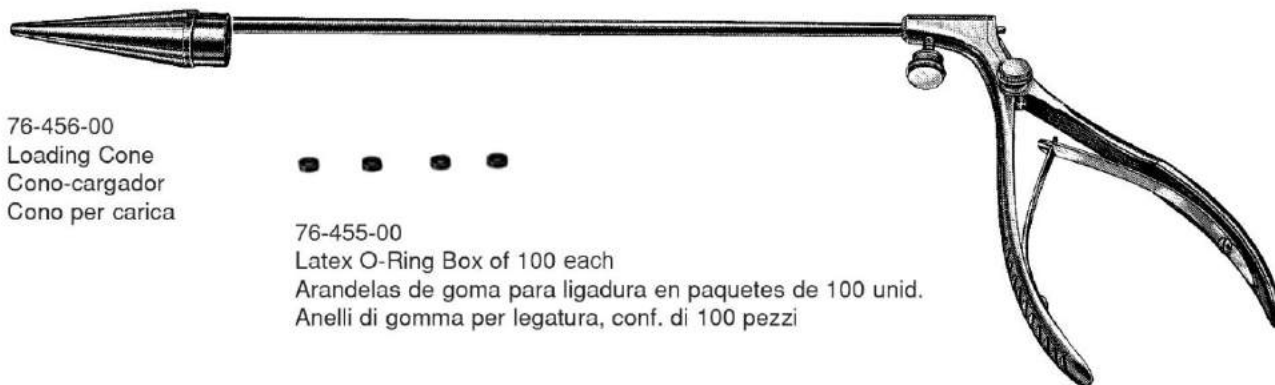

76-456-00  
Loading Cone  
Cono-cargador  
Cono per carica



76-455-00  
Latex O-Ring Box of 100 each  
Arandelas de goma para ligadura en paquetes de 100 unid.  
Anelli di gomma per legatura, conf. di 100 pezzi

McGIVNEY  
LIGATOR  
76-450-18

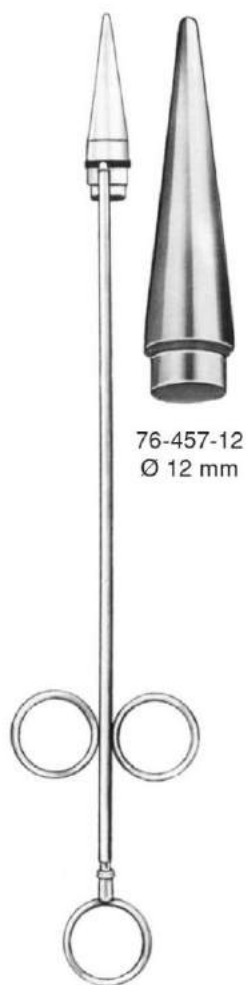

76-457-12  
Ø 12 mm

RUDD  
76-457-31  
31.5 cm, 12 1/2"  
Complete

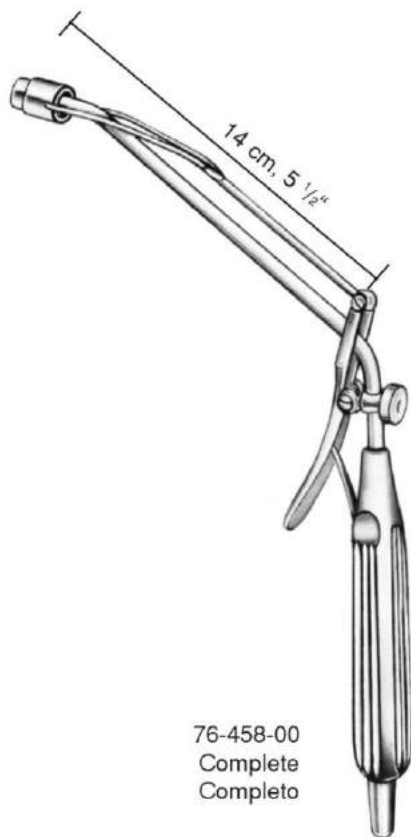

76-458-00  
Complete  
Completo



Ø 10 mm  
76-458-10  
Loading Cone  
Cono-cargador  
Cono per carica



Ø 10 mm  
76-458-11 11 mm  
76-458-16 16 mm  
Aspiration Tip  
Cabeza de aspiración  
Testa d'aspirazione

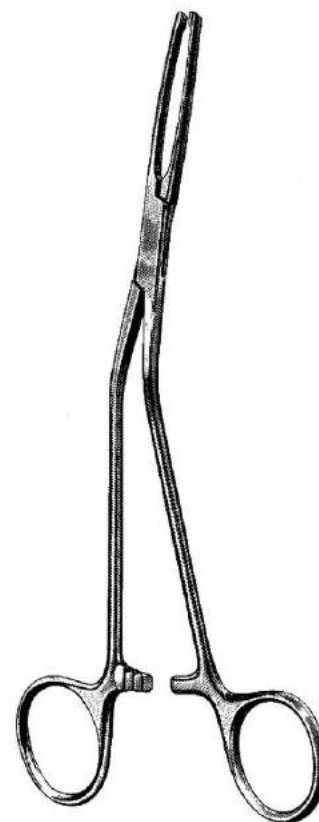

McGIVNEY  
76-460-00  
19 cm, 7 1/2"





Lateral Vaginal Retractor & Specula  
Especúlos vaginales

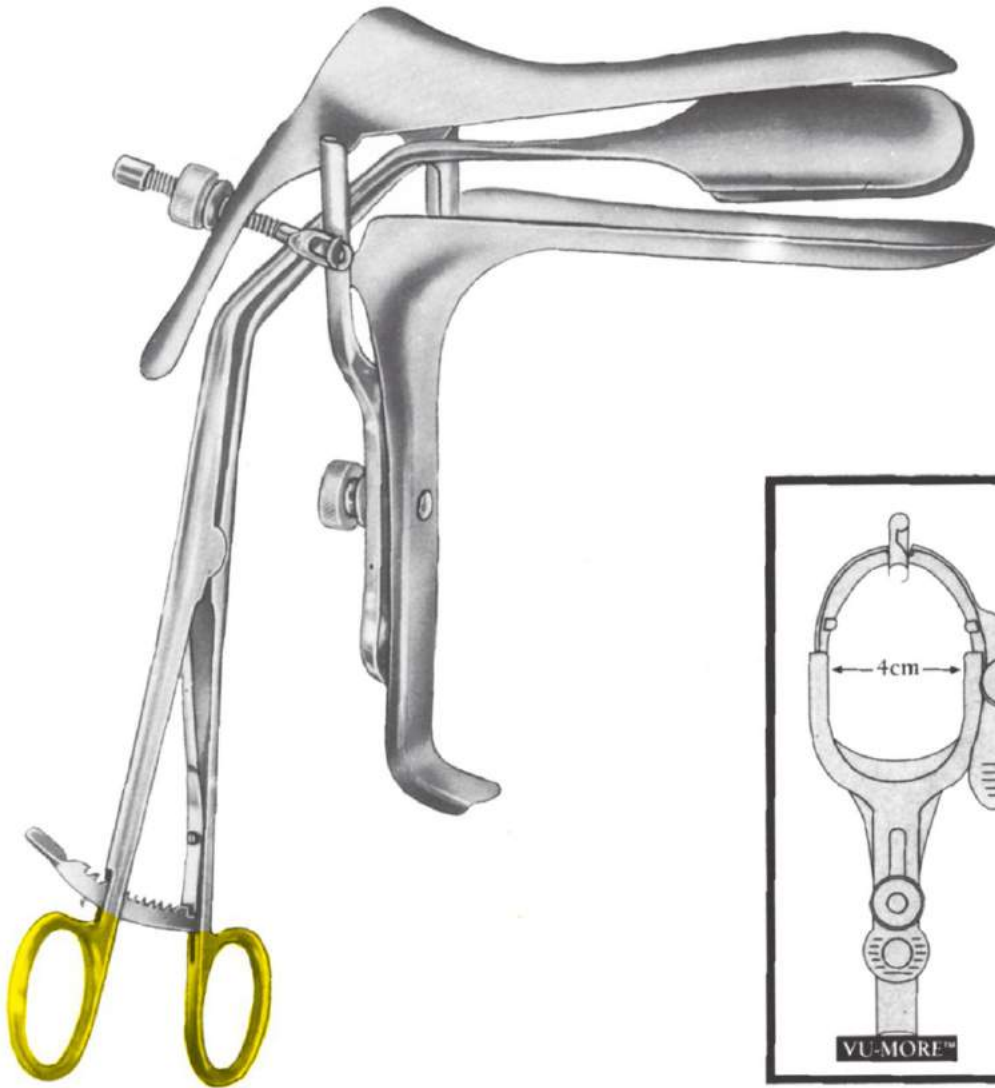

78-100-00  
Lateral Retractor  
21 cm, 8 1/4"

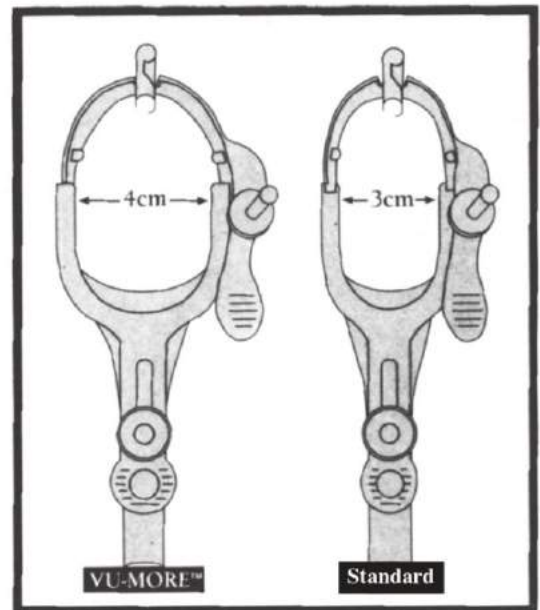

VU-MORE Specula  
78-115-02 78-115-03  
95 x 35 mm 115 x 35 mm  
See Page 570



## Vaginal Specula Espéculos vaginales

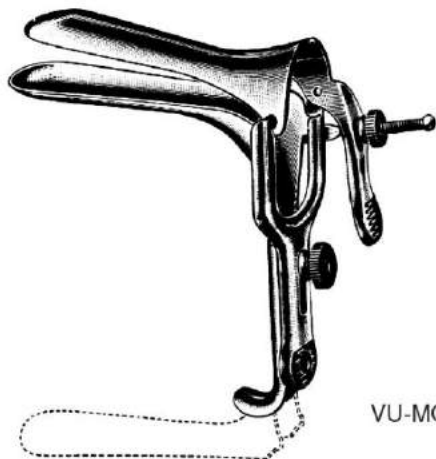

VU-MORE See Page 569

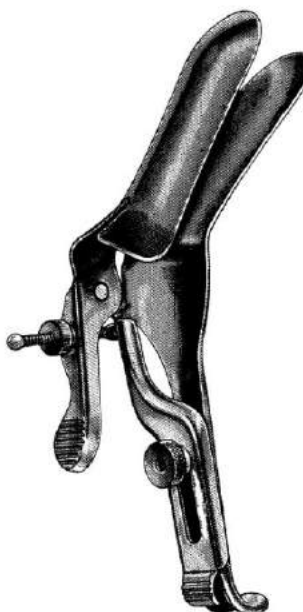

Open Right Side  
abierto a la derecha  
aperta a destra

Fig.	mm	GRAVES	
		Standard 3cm Wide	VU-MORE 4 cm Wide
1	75 x 20	78-110-01	Small
2	95 x 35	78-110-02	Medium
3	115 x 35	78-110-03	Large

GRAVES	
78-116-02	Medium, mediano, medio
101 x 35 mm	

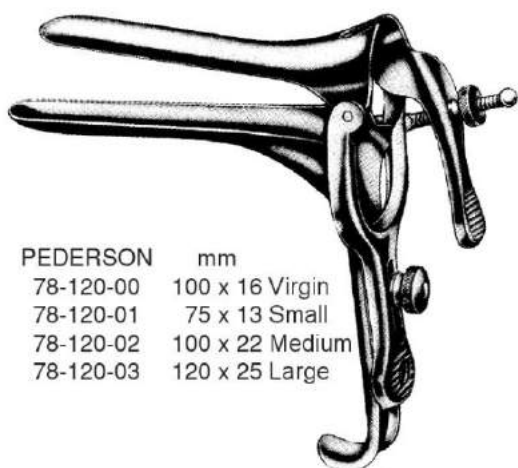

Fig.	PEDERSON	
	mm	
1	78-120-00	100 x 16 Virgin
2	78-120-01	75 x 13 Small
3	78-120-02	100 x 22 Medium
4	78-120-03	120 x 25 Large

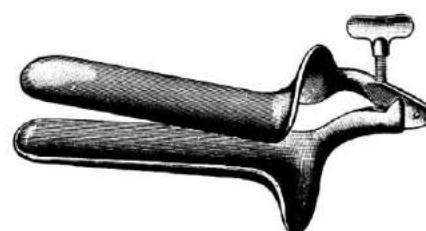
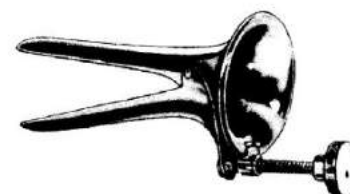

Fig.	COLLIN	
	mm	
1	78-130-01	85 x 30
2	78-130-02	100 x 35
3	78-130-03	110 x 40



Lateral Screw  
Tornillo lateral  
Vite laterale

CUSCO		
Fig.	mm	Standard
1	75 x 32	78-140-01 Small
2	85 x 35	78-140-02 Medium
3	100 x 35	78-140-03 Large
4	75 x 17	78-142-04 Virgin



COLLIN  
78-132-00  
65 x 10 mm



Vaginal Specula  
Especúlos vaginales

Central Screw  
Tornillo central  
Vite centrale

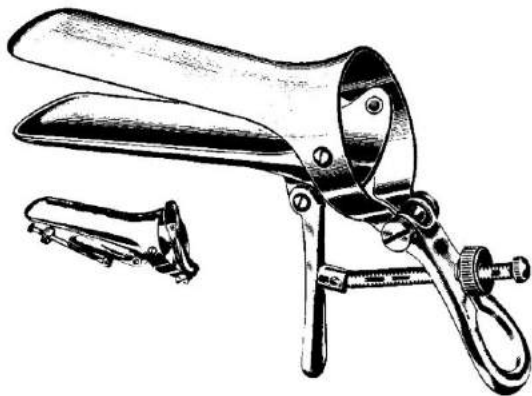

Fig.	CUSCO	mm
1	78-150-01	75 x 32
2	78-150-02	85 x 35
3	78-150-03	100 x 37

Swiss Pattern  
Modelo suizo  
Modello svizzero

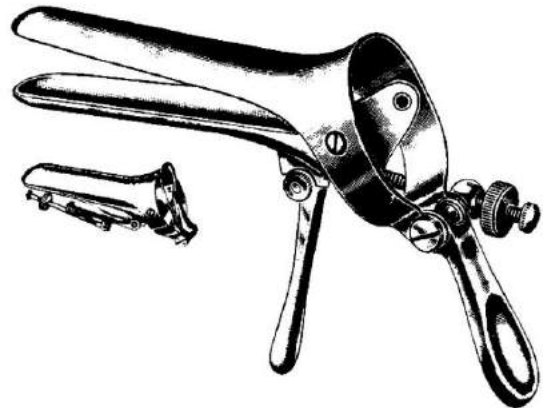
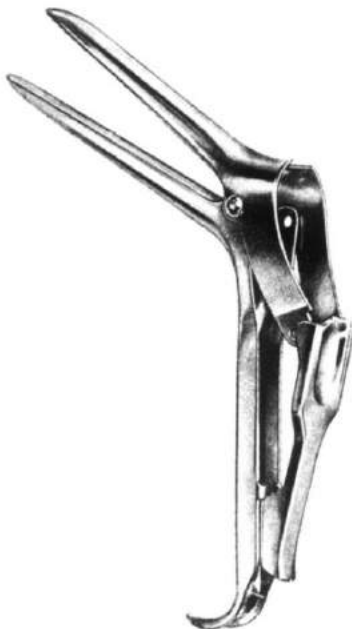

Fig.	CUSCO	mm
1	78-160-01	90 x 25
2	78-160-02	100 x 27
3	78-160-03	110 x 30



	SEMM	mm
78-161-17	100 x 20	
78-161-25	100 x 30	

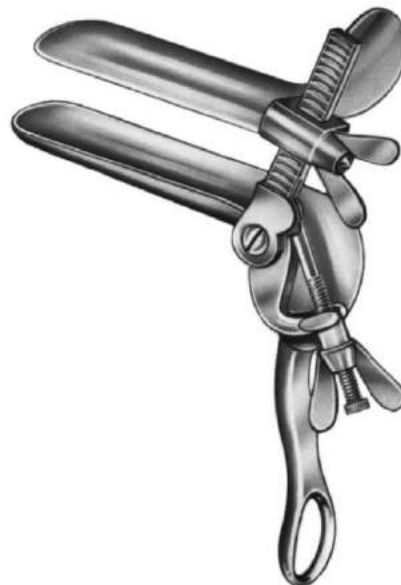

Fig.	TRÉLAT	mm
1	78-170-01	85 x 33
2	78-170-02	95 x 35
3	78-170-03	115 x 43



## Vaginal Specula Espéculos vaginales

Set Consisting of 1 Specula and 1 Retractor  
Juego de 1 espéculo y 1 valva  
Serie da 1 specolo e 1 valva

Speculum  
Espéculo  
Specolo

Retractor  
Valva  
Valve

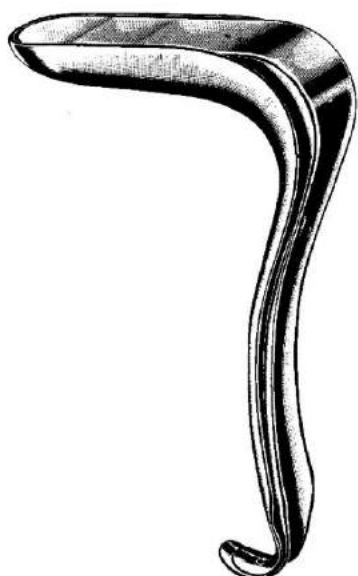

Fig.	KRISTELLER
1	78-210-01
2	78-210-02
3	78-210-03

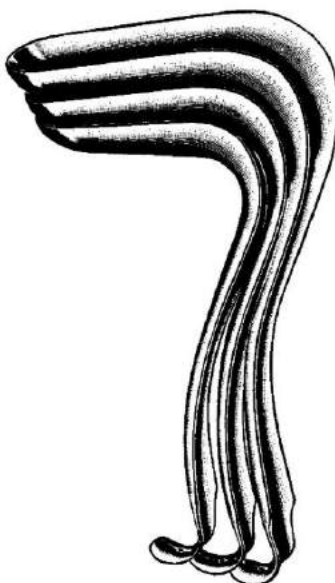

Fig.	KRISTELLER	mm
1	78-211-01	70 x 27
2	78-211-02	80 x 30
3	78-211-03	90 x 36



Fig.	KRISTELLER	mm
1	78-212-01	75 x 23
2	78-212-02	85 x 26
3	78-212-03	100 x 32

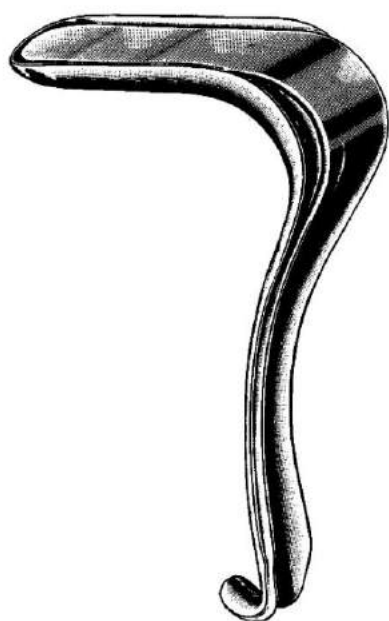

Fig.	KRISTELLER
00	78-240-00
0	78-240-10
1	78-240-01
2	78-240-02
3	78-240-03

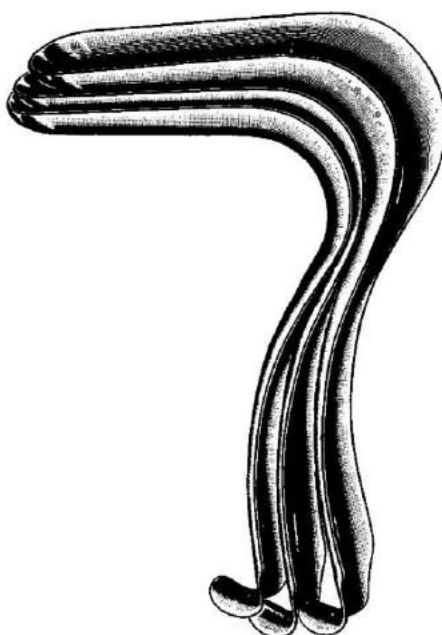

Fig.	KRISTELLER	mm
00	78-241-00	110 x 18
0	78-241-10	110 x 21
1	78-241-01	110 x 27
2	78-241-02	110 x 30
3	78-241-03	110 x 36

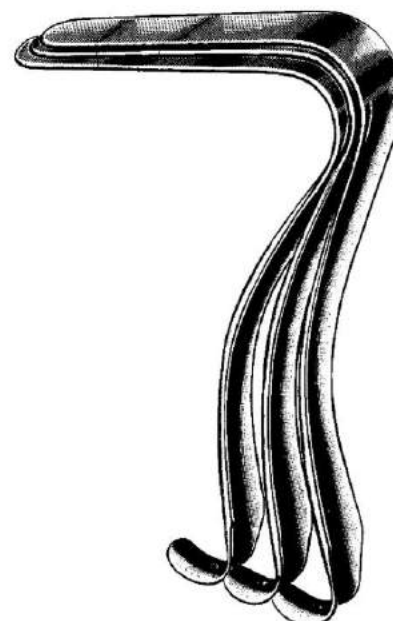

Fig.	KRISTELLER	mm
00	78-242-00	115 x 14
0	78-242-10	115 x 17
1	78-242-01	115 x 23
2	78-242-02	115 x 26
3	78-242-03	115 x 32



Vaginal Specula  
Espéculos vaginales



**KALLMORGEN**  
78-260-01 to 78-262-02

Fig.	Set	Speculum		Retractor	
	Juego	Espéculo	mm	Valva	mm
	Serie	Specolo		Valve	
1	78-260-01	78-261-01	70 x 40	78-262-01	70 x 33
2	78-260-02	78-261-02	90 x 40	78-262-02	90 x 33

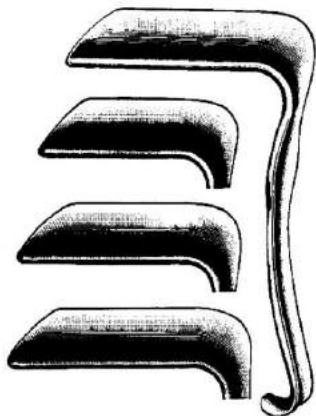

Fig.	JACKSON	mm
1	78-271-01	75 x 38
2	78-271-02	90 x 38
3	78-271-03	100 x 38

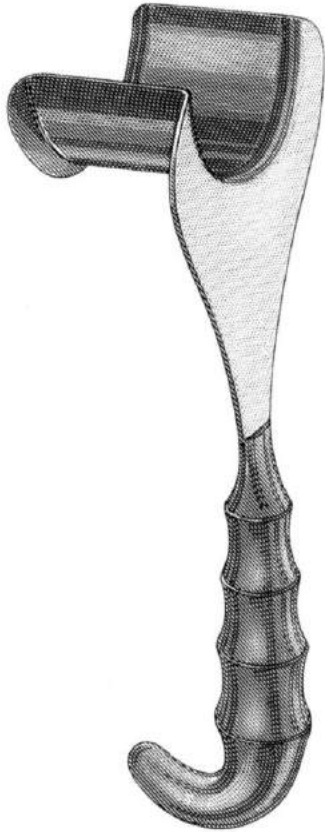

Fig.	SIMS	mm
1	78-281-01	63 x 32
2	78-281-02	76 x 32
3	78-281-03	89 x 38



Fig.	SIMS	mm
1	78-291-01	60 x 30
2	78-291-02	70 x 35
3	78-291-03	80 x 40
Set	78-291-00	Fig. 1,2,3

## Vaginal Specula Especúlos vaginales



DELEE  
78-300-01  
23.5 cm, 9 1/4"

Slightly Concave  
ligeramente concavos  
leggermente concavi

Fig.		mm
1	78-301-01	55 x 35
2	78-301-02	85 x 35
3	78-301-03	115 x 35

Fig.		mm
1	78-303-01	55 x 45
2	78-303-02	85 x 45
3	78-303-03	115 x 45
4	78-303-04	160 x 45
5	78-303-05	180 x 45

Fig.		mm
1	78-305-01	55 x 60
2	78-305-02	85 x 60
3	78-305-03	115 x 60
4	78-305-04	160 x 60
5	78-305-05	180 x 60



35 mm  
1.4"



45 mm  
1.8"



60 mm  
2.4"

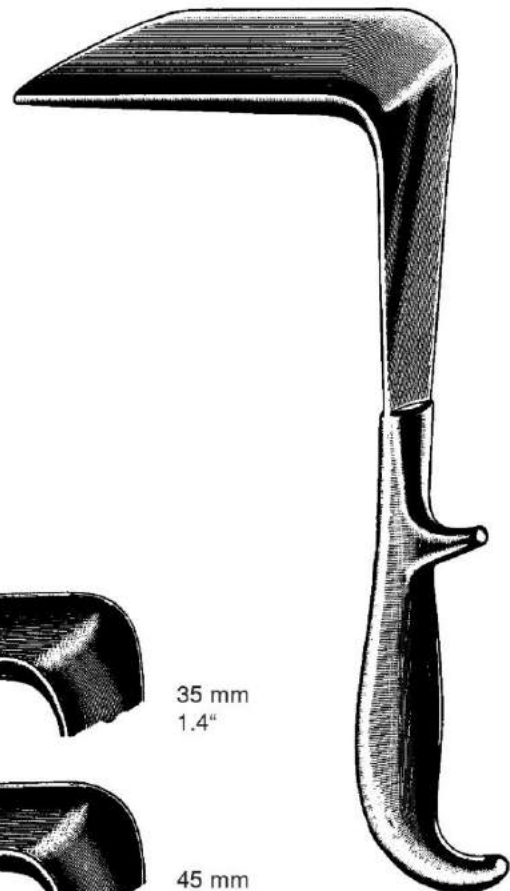

DOYEN



1 Ounce = 28.35 grams

Vaginal Specula  
Espéculos vaginales



78-306-01 to 78-306-03

78-306-01  
80 x 30 mm

78-306-02  
85 x 35 mm

78-306-03  
90 x 40 mm

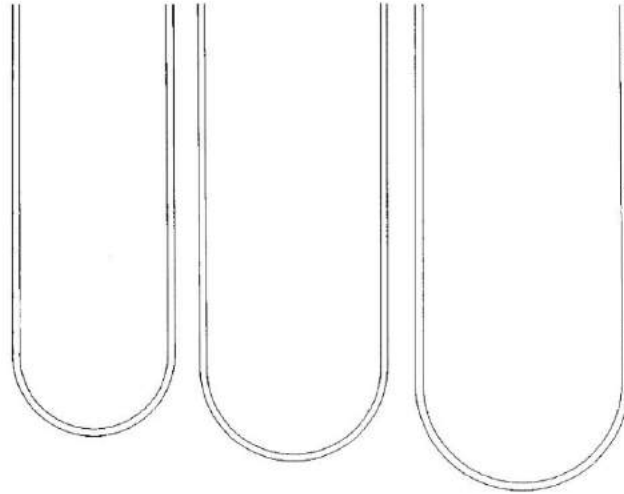

78-306-04  
Weight 400 grams  
pesa 400 g

78-306-05  
Weight 800 grams  
pesa 800 g

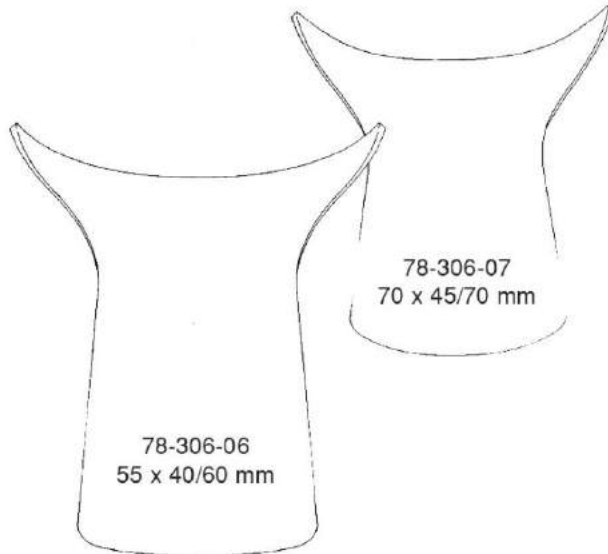

78-306-06  
55 x 40/60 mm

78-306-07  
70 x 45/70 mm

SCHERBAK  
78-306-00  
Complete Set  
juego completo  
set completo



78-306-08  
Handle  
mango



## Vaginal Retractor, Specula Especúlos vaginales



O'SULLIVAN-O'CONNOR  
78-308-00

78-308-04  
Frame only  
Marco solo  
Telaio solo

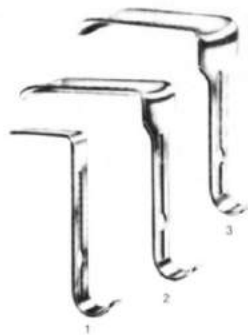

Fig. 1 45 x 17 mm 78-308-01  
Fig. 2 90 x 37 mm 78-308-02  
Fig. 3 90 x 45 mm 78-308-03

78-308-00

1 Frame with 2 Lateral Blades  
3 Interchangeable Blades Fig. 1-3

1 Marco de 2 separadores móviles laterales  
3 separadores centrales intercambiables fig. 1-3

1 telaio regolabile con 2 valve laterali mobili  
3 valve intercambiabili fig. 1-3



Detachable Weight  
Pesa desmontable  
Peso smontabile

78-307-00  
1.4 kg  
75 x 38 mm

AUVARD  
24 cm, 9 1/2"  
3lbs.

Fixed Weight  
Pesa fija  
Peso fisso

78-309-00  
1.4 kg  
105 x 38 mm





Vaginal Specula, Endospecula  
Especulos vaginales, Endo-especulos



mm	BREISKY	
100 x 20	78-310-20	28 cm, 11"
100 x 25	78-310-25	28 cm, 11"
100 x 30	78-310-30	28 cm, 11"
100 x 35	78-310-35	28 cm, 11"
100 x 40	78-310-40	28 cm, 11"
130 x 20	78-313-20	33 cm, 13"
130 x 25	78-313-25	33 cm, 13"
130 x 30	78-313-30	33 cm, 13"
130 x 35	78-313-35	33 cm, 13"
130 x 40	78-313-40	33 cm, 13"
155 x 40	78-315-40	



mm	LANDAU	
100 x 28	78-319-28	29 cm, 11.4"
100 x 38	78-319-38	29 cm, 11.4"

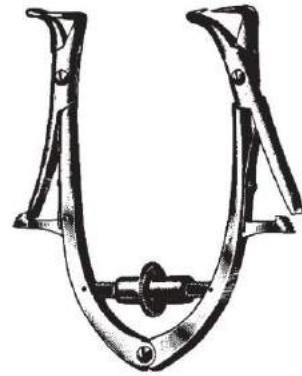

FRIEDMAN	
78-351-10	10 cm, 4"

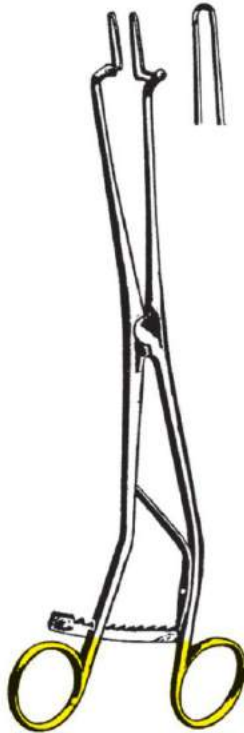

KOGAN		
78-360-24	3 mm	24 cm, 9 1/2"
78-361-24	4 mm	24 cm, 9 1/2"
78-362-24	5 mm	24 cm, 9 1/2"



KOGAN		
78-363-24	3 mm	24 cm, 9 1/2"
78-364-24	4 mm	24 cm, 9 1/2"
78-365-24	5 mm	24 cm, 9 1/2"

## Uterine Dilators Dilatadores uterinos



mm Ø	HEGAR		mm Ø
1	78-410-01	78-415-01	1.5
2	78-410-02	78-415-02	2.5
3	78-410-03	78-415-03	3.5
4	78-410-04	78-415-04	4.5
5	78-410-05	78-415-05	5.5
6	78-410-06	78-415-06	6.5
7	78-410-07	78-415-07	7.5
8	78-410-08	78-415-08	8.5
9	78-410-09	78-415-09	9.5
10	78-410-10	78-415-10	10.5
11	78-410-11	78-415-11	11.5
12	78-410-12	78-415-12	12.5
13	78-410-13	78-415-13	13.5
14	78-410-14	78-415-14	14.5
15	78-410-15	78-415-15	15.5
16	78-410-16	78-415-16	16.5
17	78-410-17	78-415-17	17.5
18	78-410-18	78-415-18	18.5
19	78-410-19	78-415-19	19.5
20	78-410-20		
21	78-410-21		
22	78-410-22		
23	78-410-23		
24	78-410-24		
25	78-410-25		
26	78-410-26		
27	78-410-27		
28	78-410-28		
29	78-410-29		
30	78-410-30		

HEGAR Set of 14 Each  
78-405-14 In Case

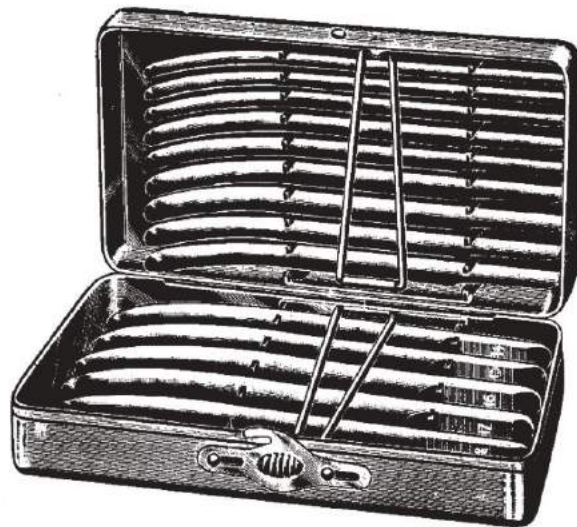

mm HEGAR  
4-17 78-406-14 Set of 14 Each  
1-26 78-406-26 Set of 26 Each

78-404-14 Set of 14 Each  
78-410-04 to 78-410-17  
78-404-26 Set of 26 Each  
78-410-01 to 78-410-26

In Metal Case  
en estuche de metal



## Uterine Dilators Dilatadores uterinos



mm	HEGAR
1/2	78-420-01
3/4	78-420-03
5/6	78-420-05
7/8	78-420-07
9/10	78-420-09
11/12	78-420-11
13/14	78-420-13
15/16	78-420-15
17/18	78-420-17
19/20	78-420-19
21/22	78-420-21
23/24	78-420-23
25/26	78-420-25

78-424-08	Set of 8 Each 78-420-03 to 78-420-17 3/4 to 17/18 mm
78-424-13	Set of 13 Each 78-420-01 to 78-420-25 1/2 to 25/26 mm

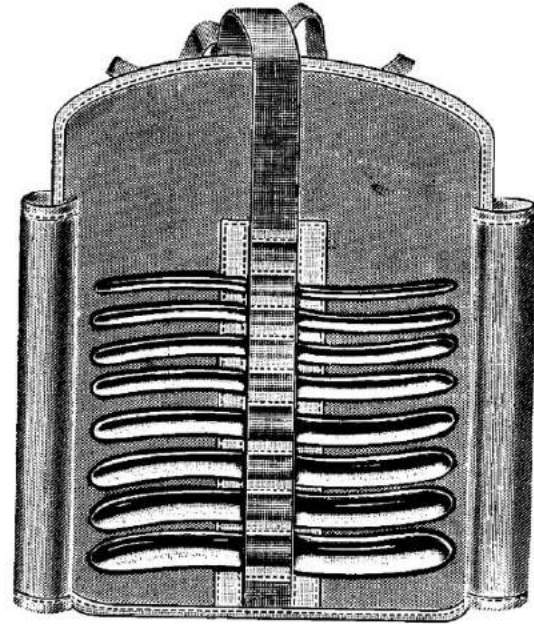

mm	HEGAR
3/4 to 17/18	78-425-08 Set of 8 Each

In Khaki Roll  
en bolsa de tela

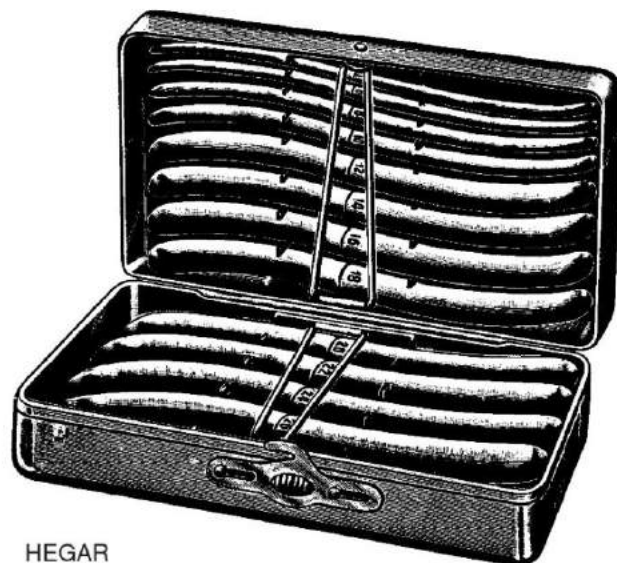

mm	HEGAR
3/4 to 17/18	78-426-08 Set of 8 Each
1/2 to 25/26	78-426-13 Set of 13 Each

In Metal Case  
en estuche de metal, in astuccio metallico



## Uterine Dilators Dilatadores uterinos

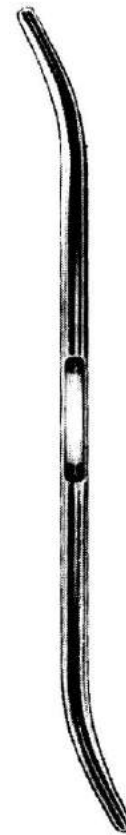
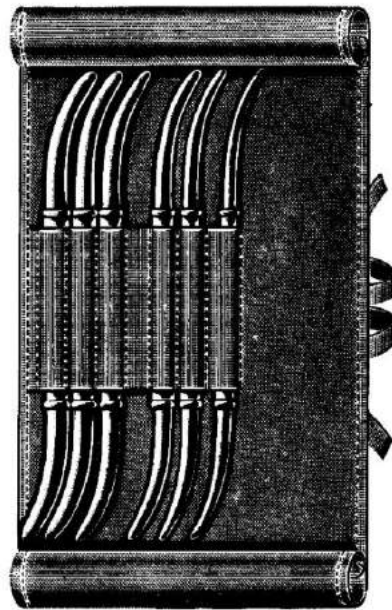
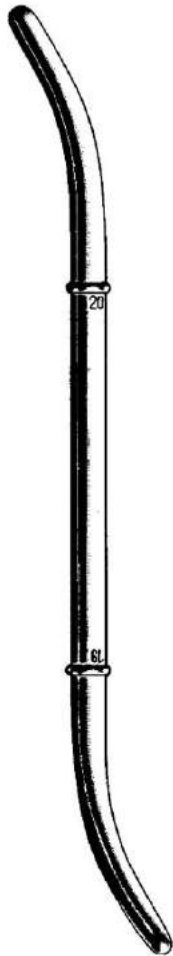

mm	HANK	Size
4.5/5	78-430-10	9/10
5.5/6	78-430-12	11/12
6.5/7	78-430-14	13/14
7.5/8	78-430-16	15/16
8.5/9	78-430-18	17/18
9.5/10	78-430-20	19/20

78-435-06 Set of 6 Each

HANK  
78-436-06  
Set of 6 Each  
In Khaki Roll

PRATT		
78-438-13 to 78-438-41		
78-438-00		
Set of 8 Each		
	Size	mm
78-438-13	13-15	4.5/8.0
78-438-17	17-19	5.6/6.3
78-438-21	21-23	7.0/7.6
78-438-25	25-27	8.3/9.0
78-438-29	29-32	9.6/10.3
78-438-33	33-35	11.0/11.6
78-438-37	37-39	12.3/13.0
78-438-41	41-43	13.6/14.3



Uterine Dilators  
Dilatadores uterinos

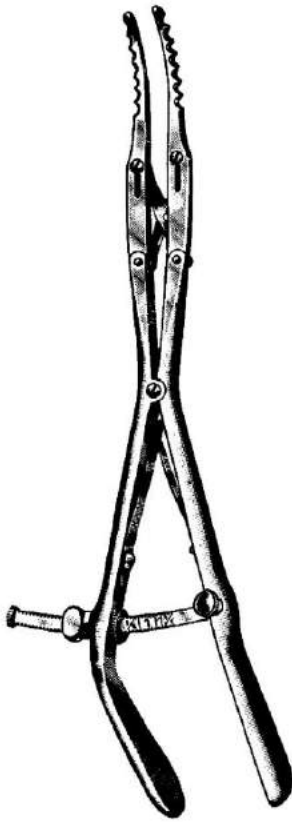

GOODELL  
78-441-34  
34 cm, 13.4"

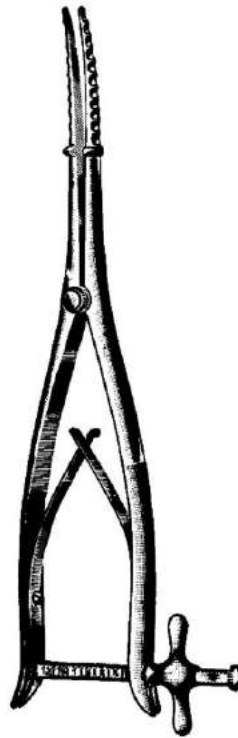

WYLIE  
78-443-29  
29 cm, 11.4"

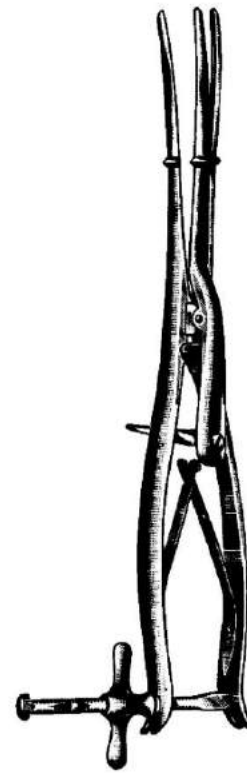

SIMS  
78-445-29  
29 cm, 11.4"



Tenaculum Forceps  
Pinzas para coger el cuello del útero

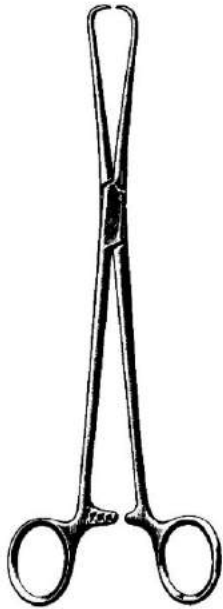

SCHROEDER (POZZI)  
78-502-25  
25 cm, 10"

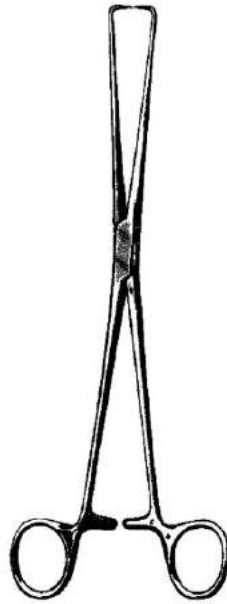

BRAUN  
78-504-25  
25 cm, 10"



SKENE  
78-505-24  
24 cm, 9 1/2"

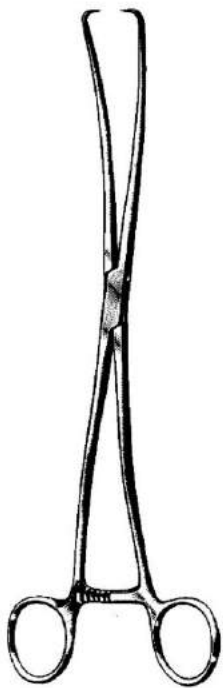

DUPLAY  
78-507-28  
28 cm, 11"



STAUDE-MOORE  
78-508-17  
17 cm, 6 3/4"

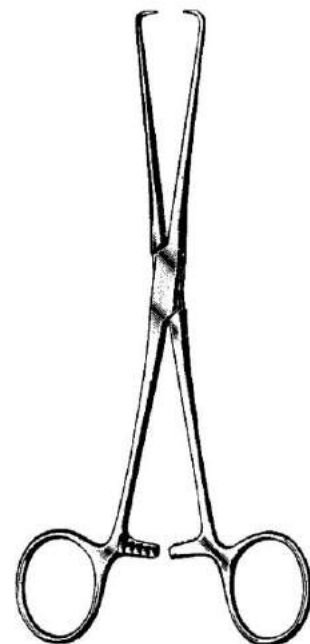

BARRETT  
78-510-18  
18 cm, 7"



Tenaculum, Vulsellum Forceps  
Pinzas para coger el cuello del útero



JARCHO  
78-512-20  
20 cm, 8"

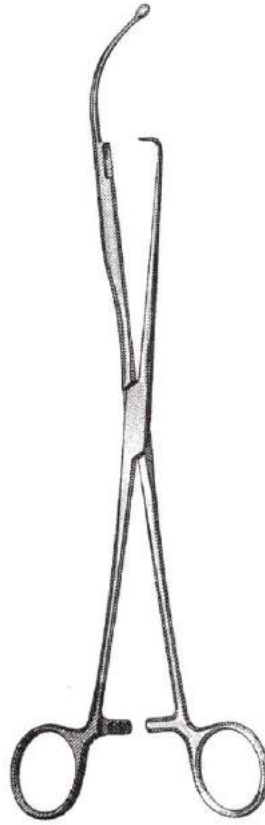

HULKA  
78-512-28  
28 cm, 11"

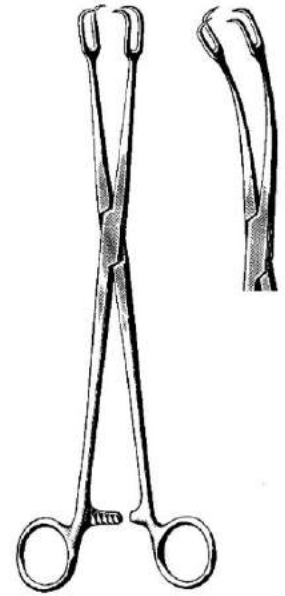

SCHROEDER  
78-514-24 78-515-24  
24 cm, 9 1/2"

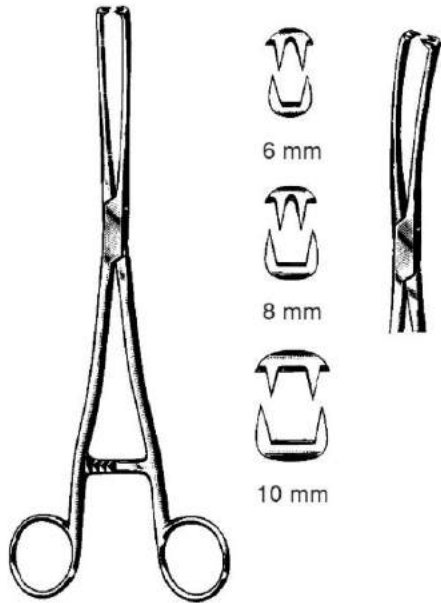

6 mm  
8 mm  
10 mm

MUSEUX  
78-524-06 6 mm 78-525-06  
78-524-08 8 mm 78-525-08  
78-524-10 10 mm 78-525-10  
24 cm, 9 1/2"



TEALE  
78-531-23  
23 cm, 9"

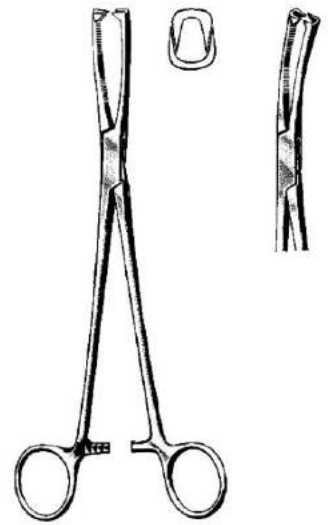

JACOBS  
78-532-21 78-533-21  
21 cm, 8 1/4"



Vulsellum, Tumor Forceps  
Pinzas para coger el cuello del útero



PRATT  
78-536-28  
28 cm, 11"

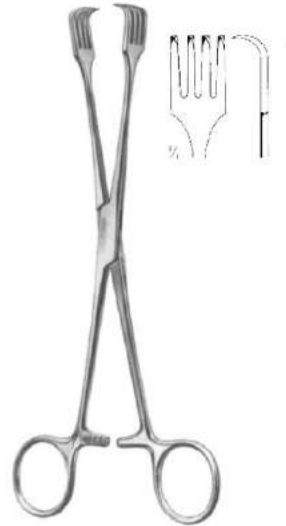

CZERNY  
78-536-21  
20 cm, 8"

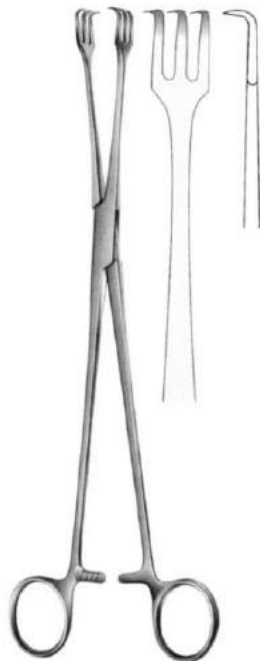

SCHROEDER  
78-537-27  
27 cm, 10 1/2"



IOWA  
78-539-26  
26 cm, 10 1/4"





Uterine Polyp Forceps, Uterine Elevating Forceps  
Pinzas para pólipos uterinos, Pinzas para el útero

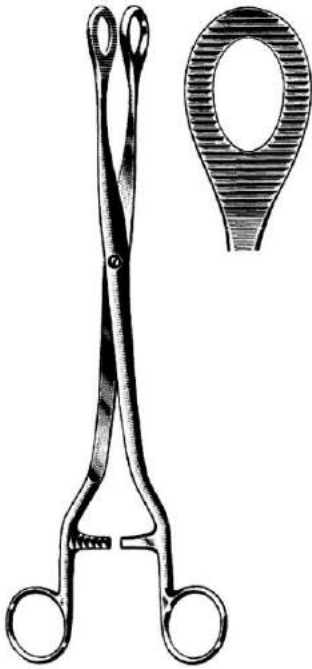

**NOTO**  
78-540-27  
27 cm, 10 1/2"



**DOYEN**  
78-542-20  
20 cm, 8"

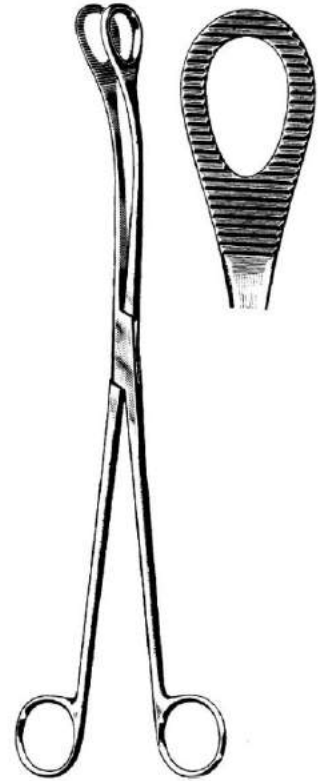

**KELLY**  
78-543-32  
32 cm, 12 3/4"



**DARTIGUES**  
78-545-27  
27 cm, 10 1/2"



**SOMER**  
78-547-23  
23 cm, 9"



**COLLIN**  
78-549-25  
25 cm, 10"



Amniotome, Uterine Depressors, Uterine Sounds  
 Amniótomo, Depresores uterinos, Histerómetros



**BEACHAM**  
 78-559-26  
 26 cm, 10 1/4"



**BRAUN**  
 78-565-28  
 28 cm, 11"

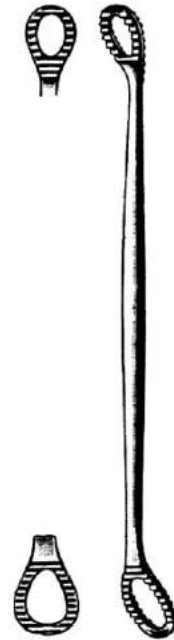

**SIMS**  
 78-567-26  
 26 cm, 10 1/4"



Rigid  
 rigido  
 rigida  
 78-580-32  
 32 cm, 12 3/4"

Malleable  
 maleable  
 malleabile  
 78-581-32

**SIMS**



Rigid  
 rigido  
 rigida  
 78-582-32  
 32 cm, 12 3/4"

Malleable  
 maleable  
 malleabile  
 78-583-32

**SIMPSON**



**COLLIN**  
 78-584-28  
 28 cm, 11"



**VALLEIX**  
 78-585-25



## Uterine Biopsy Curettes Curetas aspiradoras p. la biopsia uterina



RANDALL  
78-590-04  
24 cm, 9 1/2"  
Ø 4 mm

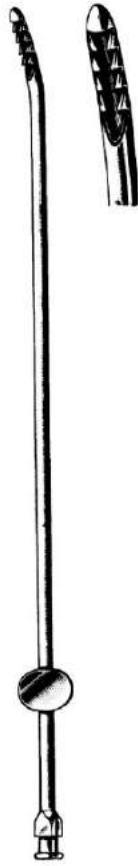

NOVAK  
78-592-01 1 mm  
78-592-02 2 mm  
78-592-03 3 mm  
78-592-04 4 mm



HEANY  
78-593-00  
22.5 cm, 8.9"



78-594-40



78-596-40

KEVORKIAN  
4.0 mm  
30 cm, 11 3/4"  
Without Basket  
sin cesto  
senza cestello  
78-594-40

With Basket  
con cesto  
con cestello  
78-596-40



MOD. MUENCHEN  
78-598-27  
27 cm, 10 1/2"





Biopsy Forceps  
Pinzas para biopsia



SCHUMACHER  
24 cm, 9 1/2"

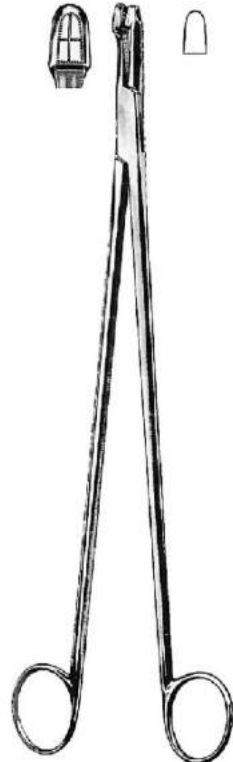

SCHUBERT  
78-604-21 21 cm, 8 1/4"  
78-604-28 28 cm, 11"

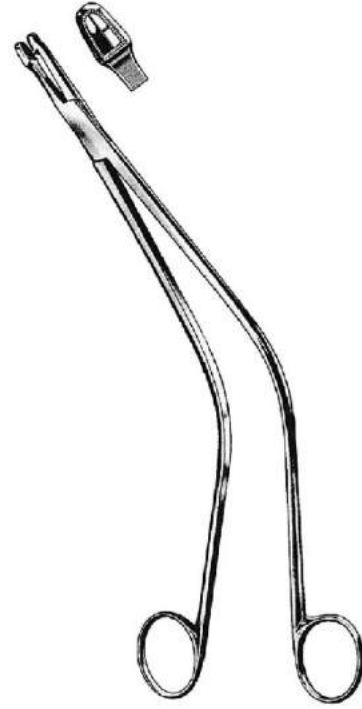

SCHUBERT  
78-605-26  
26 cm, 10 1/4"

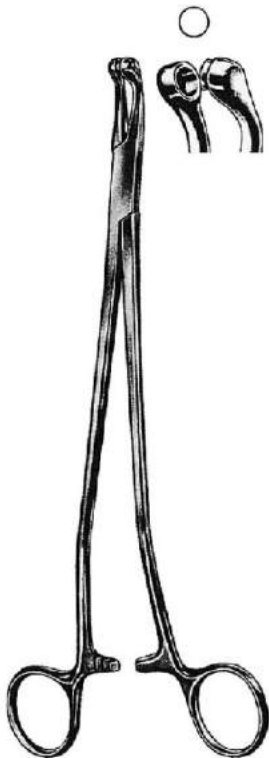

THOMAS-GAYLOR  
78-606-24  
24 cm, 9 1/2"

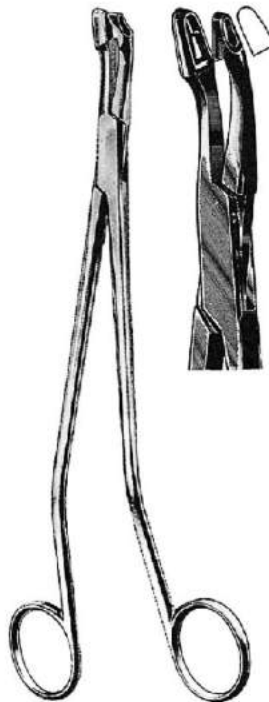

SCHUBERT S SHAPE  
78-611-25  
25 cm, 10"



FAURE  
78-612-21  
21 cm, 8 1/4"



Biopsy Forceps  
Pinzas para biopsia

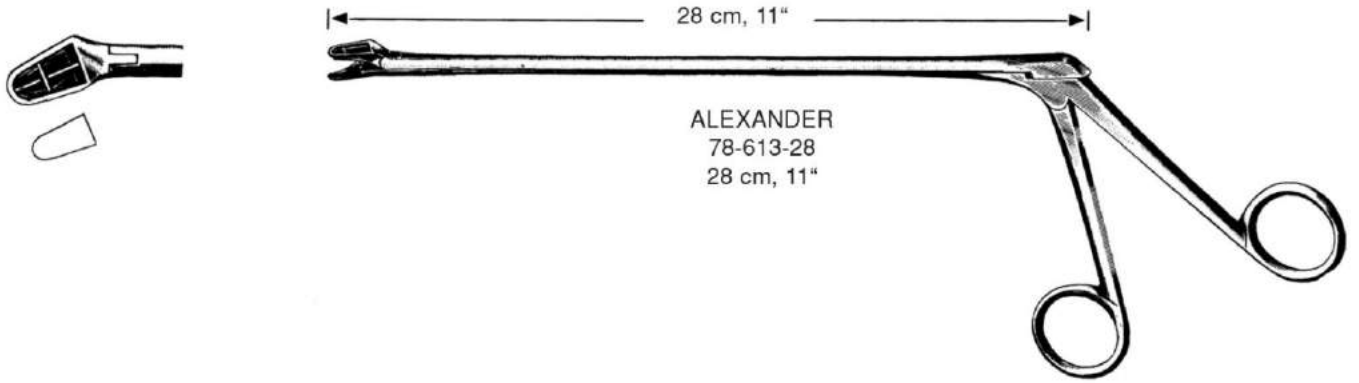

ALEXANDER  
78-613-28  
28 cm, 11"

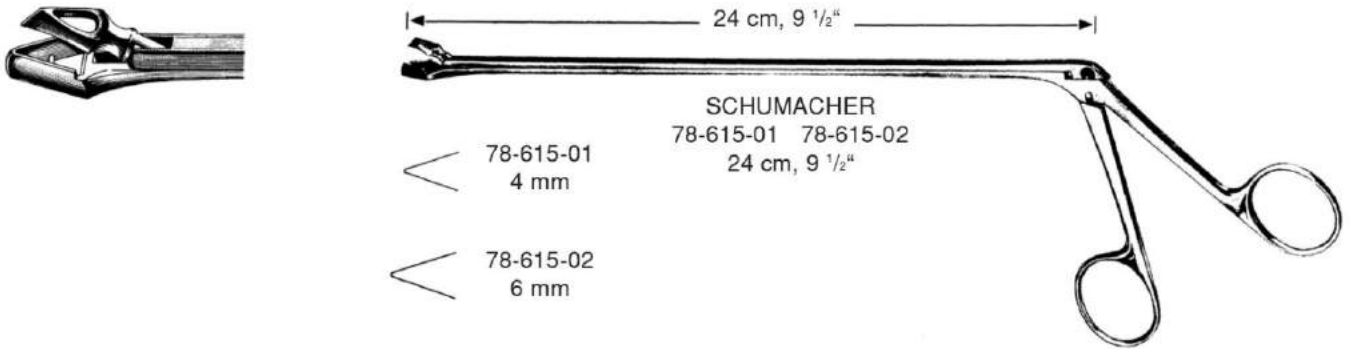

SCHUMACHER  
78-615-01 78-615-02  
24 cm, 9 1/2"

78-615-01  
4 mm

78-615-02  
6 mm

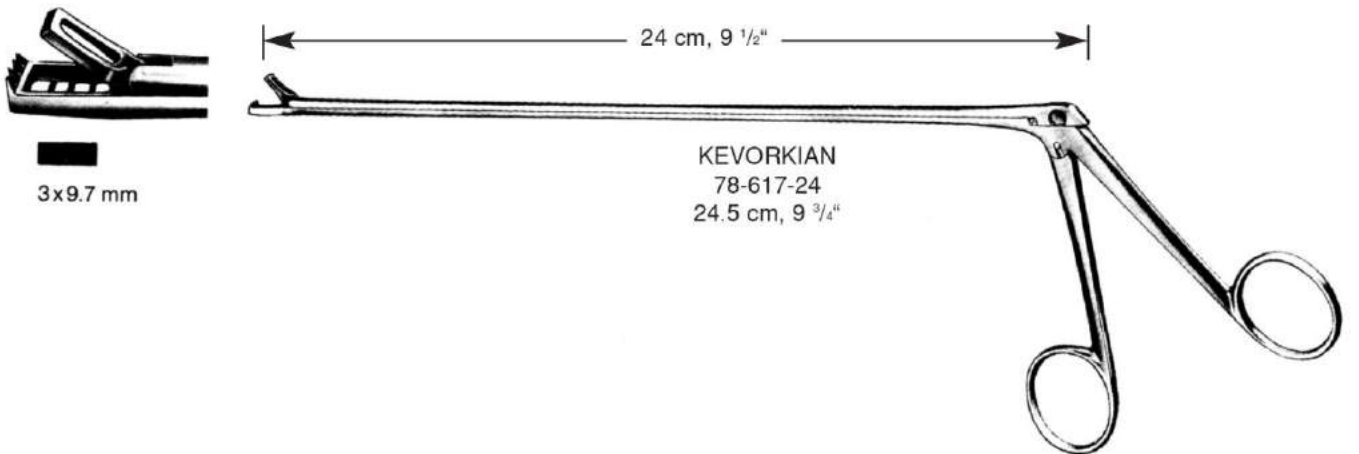

KEVORKIAN  
78-617-24  
24.5 cm, 9 3/4"

3x9.7 mm

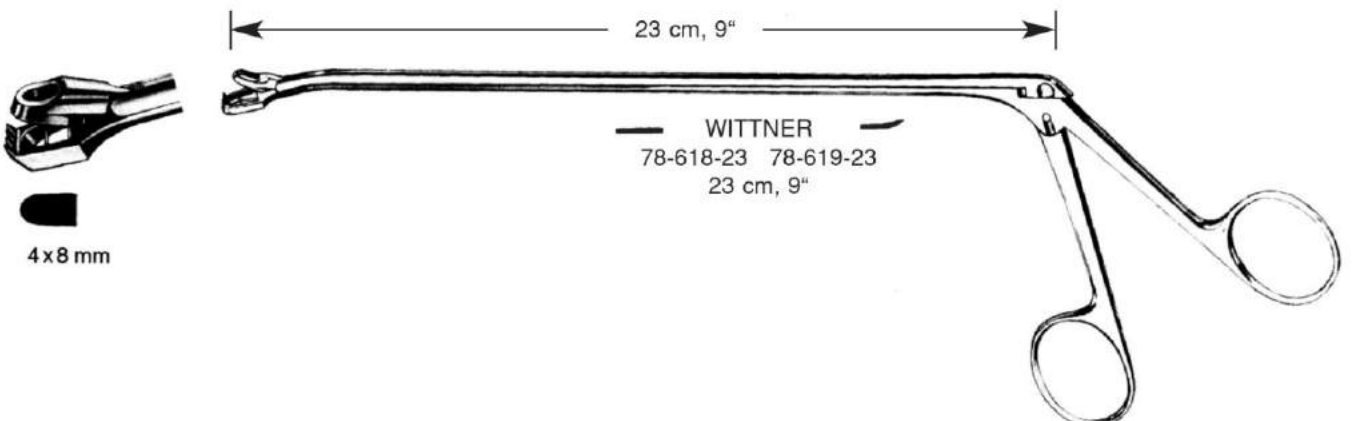

WITTNER  
78-618-23 78-619-23  
23 cm, 9"

4x8 mm

## Biopsy Forceps Pinzas sacabocado p. biopsia



4 x 8 mm

20 cm, 8"

**EPPENDORFER**  
78-630-20

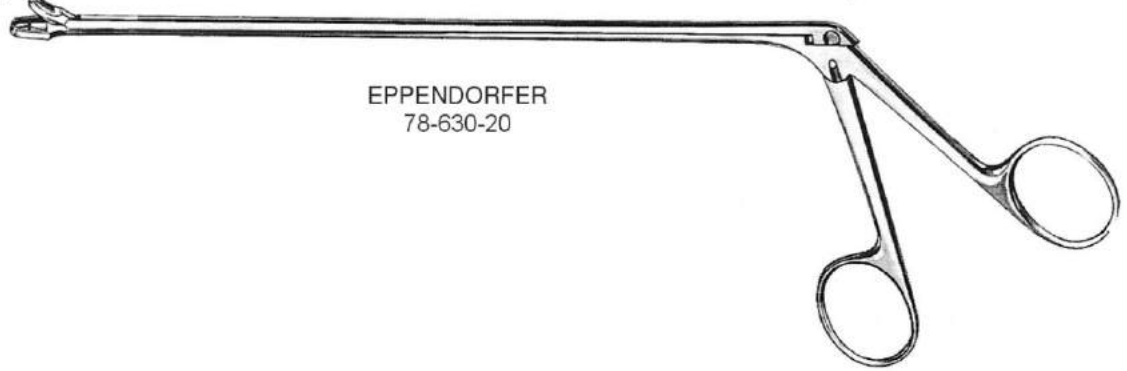

3 x 7 mm

20 cm, 8"

**TISCHLER**

78-621-20      20 cm, 8" Shaft  
78-621-25      25 cm, 10" Shaft

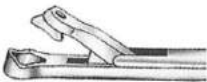
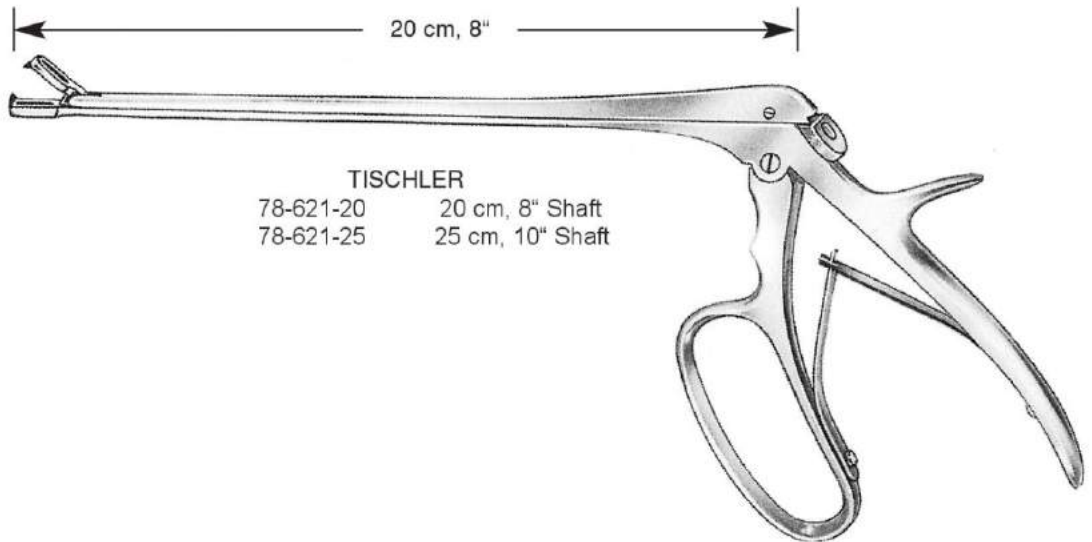

7 x 5 mm

20 cm, 8"

**BURKE**

78-622-20      20 cm, 8" Shaft  
78-622-25      25 cm, 10" Shaft

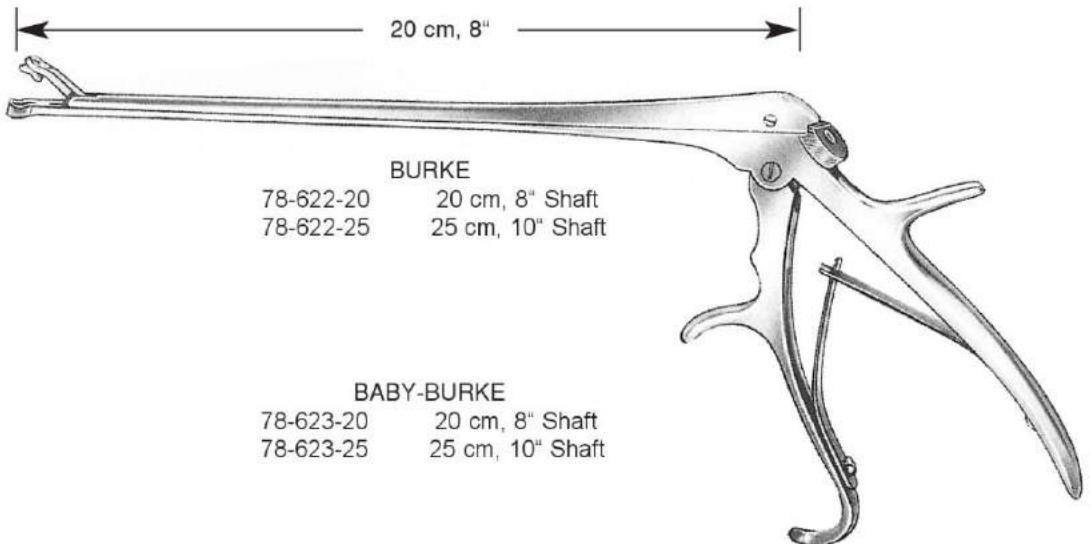

4.5 x 3 mm

**BABY-BURKE**

78-623-20      20 cm, 8" Shaft  
78-623-25      25 cm, 10" Shaft



## Rotating Biopsy Forceps Pinzas sacabocado p. biopsia



Fig. 1

TISCHLER



Fig. 6

TISCHLER UP



Fig. 3

Oval ● 3,7x5 mm

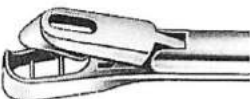

Fig. 7

TISCHLER DOWN



Fig. 4

KEVORKIAN



Fig. 8

BABY-TISCHLER UP



Fig. 5

BABY-TISCHLER

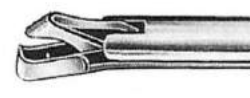
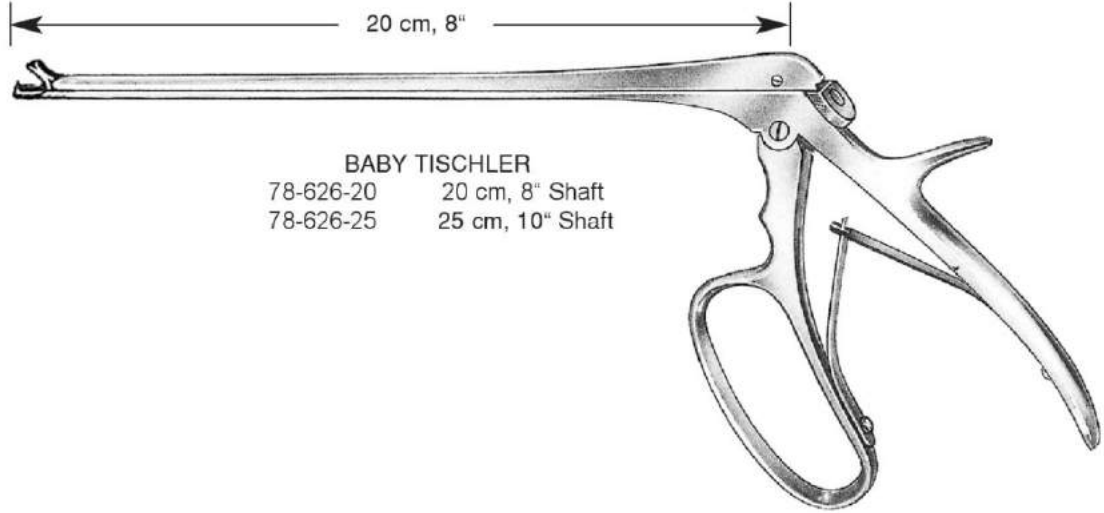
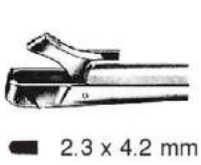

Fig. 9

BABY-TISCHLER DOWN

Fig.	Complete with Shaft and Handle	Interchangeable Shaft Only, 20 cm
1	78-624-01	78-624-11
3	78-624-03	78-624-13
4	78-624-04	78-624-14
5	78-624-05	78-624-15
6	78-624-06	78-624-16
7	78-624-07	78-624-17
8	78-624-08	78-624-18
9	78-624-09	78-624-19

**Biopsy Forceps**  
Pinzas sacabocado p. biopsia



**BABY TISCHLER**  
78-626-20 20 cm, 8" Shaft  
78-626-25 25 cm, 10" Shaft

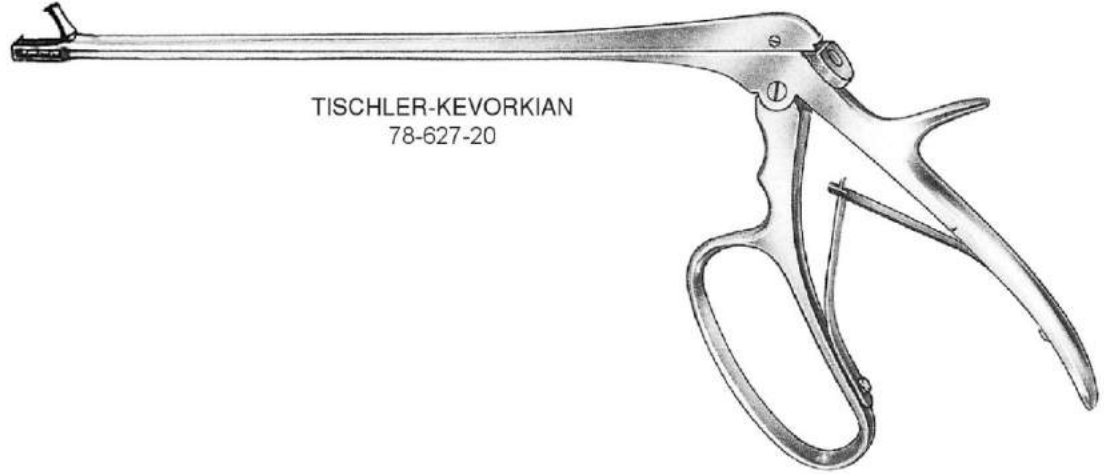

**TISCHLER-KEVORKIAN**  
78-627-20

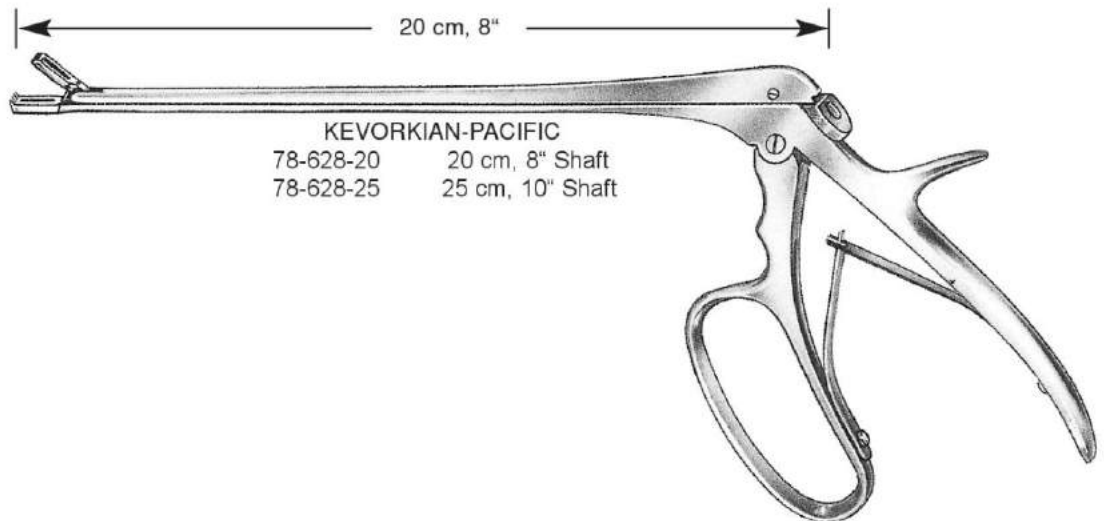
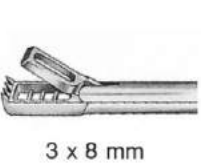

**KEVORKIAN-PACIFIC**  
78-628-20 20 cm, 8" Shaft  
78-628-25 25 cm, 10" Shaft





Biopsy Forceps  
Pinzas sacabocado p. biopsia

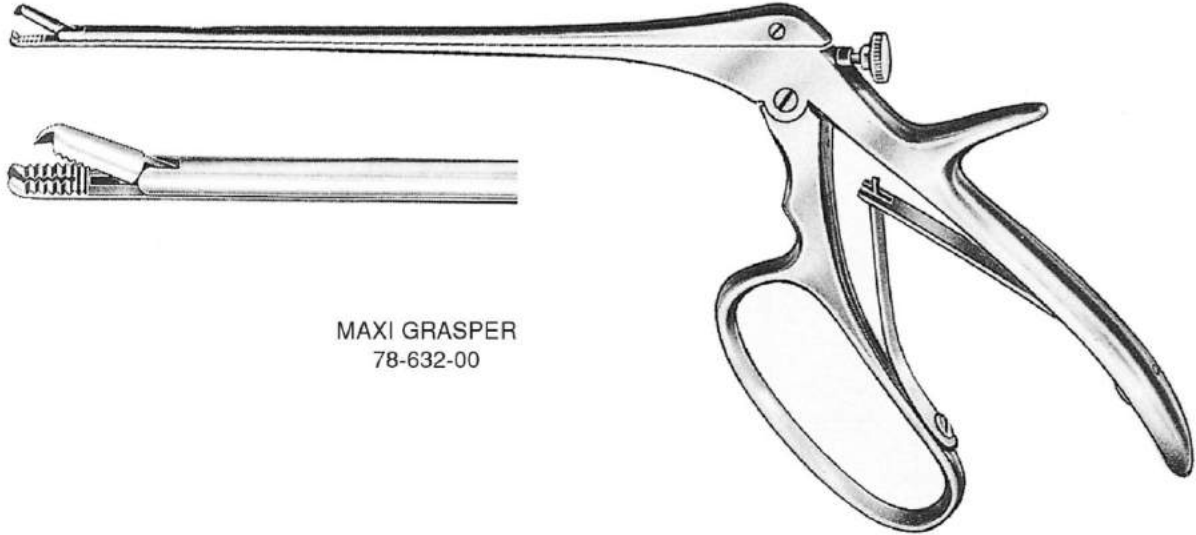

MAXI GRASPER  
78-632-00

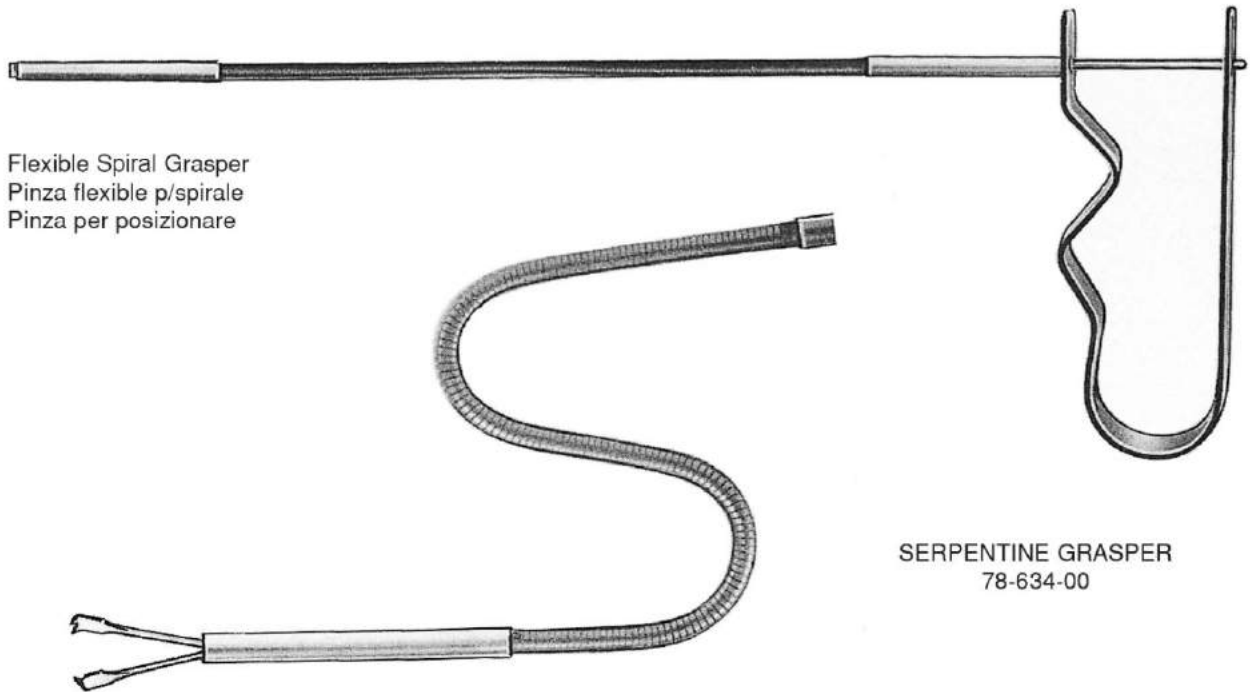

Flexible Spiral Grasper  
Pinza flexible p/spirale  
Pinza per posizionare

SERPENTINE GRASPER  
78-634-00



I.U.D.  
Extractor Hook  
78-635-26  
26 cm, 10 1/4"



Myoma Screw, Myoma Knife, Fistula Hook, Measuring Instruments, Uterine Curettes

Tirabuzón para fibromas, Bisturi para fibromas, Ganchos para fistulas, Instrumental para medir, Curetas uterinas



DOYEN  
78-641-17  
17 cm, 6 3/4"

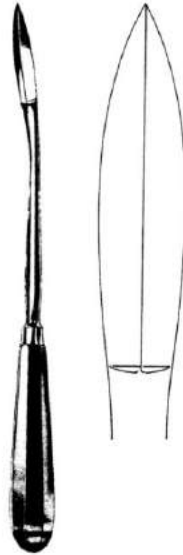

SEGOND  
78-643-27  
27 cm, 10 1/2"



78-645-01  
Fig. 1

78-645-02  
Fig. 2

78-645-03  
Fig. 3

EMMET  
78-645-01 to 78-645-03  
22 cm, 8 3/4"



78-646-01



78-646-02

Sharp  
cortante  
tagliente

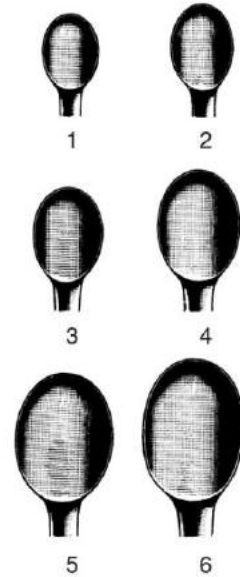

Fig. SIMON  
1 78-702-01  
2 78-702-02  
3 78-702-03  
4 78-702-04  
5 78-702-05  
6 78-702-06  
25 cm, 10"



## Uterine Curettes Curetas uterinas



SCHROEDER  
31 cm, 12 1/4"

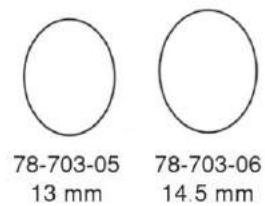
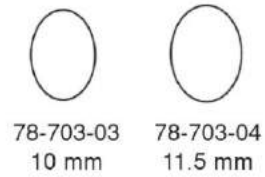
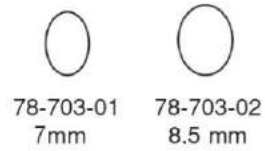

Sharp/Blunt  
cortante/roma  
tagliante/smussa

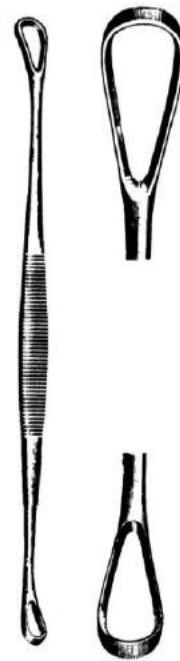

BLAKE  
78-704-27  
27 cm, 10 1/2"





Uterine Curettes  
Curetetas uterinas



**SIMS**  
78-710-05 to 78-717-14  
28 cm, 11"

	Sharp cort. tagl.	Fig.	mm	Blunt roma smussa
fest	78-710-05	00	5.0	78-715-05
rig.	78-710-06	0	6.0	78-715-06
	78-710-07	1	7.5	78-715-07
	78-710-08	2	8.5	78-715-08
	78-710-09	3	10.0	78-715-09
	78-710-11	4	11.5	78-715-11
	78-710-12	5	13.5	78-715-12
	78-710-14	6	14.5	78-715-14



**RECAMIER**  
78-720-05 to 78-727-20  
31 cm, 12 1/4"

	Sharp cort. tagl.	Fig.	mm	Blunt roma smussa
fest	78-720-05	00	5	78-725-05
rig.	78-720-06	0	6	78-725-06
	78-720-07	1	7	78-725-07
	78-720-08	2	8	78-725-08
	78-720-09	3	9	78-725-09
	78-720-11	4	11	78-725-11
	78-720-12	5	12	78-725-12
	78-720-14	6	14	78-725-14
	78-720-15	7	15	78-725-15
	78-720-16	8	16	78-725-16
	78-720-19	9	19	78-725-19
	78-720-20	10	20	78-725-20



**BUMM**  
78-730-30 to 78-737-40  
28 cm, 11"

	Sharp cort. tagl.	Fig.	Blunt roma smussa
fest	78-730-30	14	78-735-30
rig.	78-730-35	15	78-735-35
	78-730-40	16	78-735-40

	flexible fless.	Fig.	mm	78-717-05
	78-712-05	00	5.0	78-717-05
	78-712-06	0	6.0	78-717-06
	78-712-07	1	7.5	78-717-07
	78-712-08	2	8.5	78-717-08
	78-712-09	3	10.0	78-717-09
	78-712-11	4	11.5	78-717-11
	78-712-12	5	13.5	78-717-12
	78-712-14	6	14.5	78-717-14

	flexible fless.	Fig.	mm	78-727-05
	78-722-05	00	5	78-727-05
	78-722-06	0	6	78-727-06
	78-722-07	1	7	78-727-07
	78-722-08	2	8	78-727-08
	78-722-09	3	9	78-727-09
	78-722-11	4	11	78-727-11
	78-722-12	5	12	78-727-12
	78-722-14	6	14	78-727-14
	78-722-15	7	15	78-727-15
	78-722-16	8	16	78-727-16
	78-722-19	9	19	78-727-19
	78-722-20	10	20	78-727-20

	flexible fless.	Fig.	78-737-30
	78-732-30	14	78-737-30
	78-732-35	15	78-737-35
	78-732-40	16	78-737-40

See page 598 for  
working end illustrations



Uterine Curettes  
Curetas uterinas

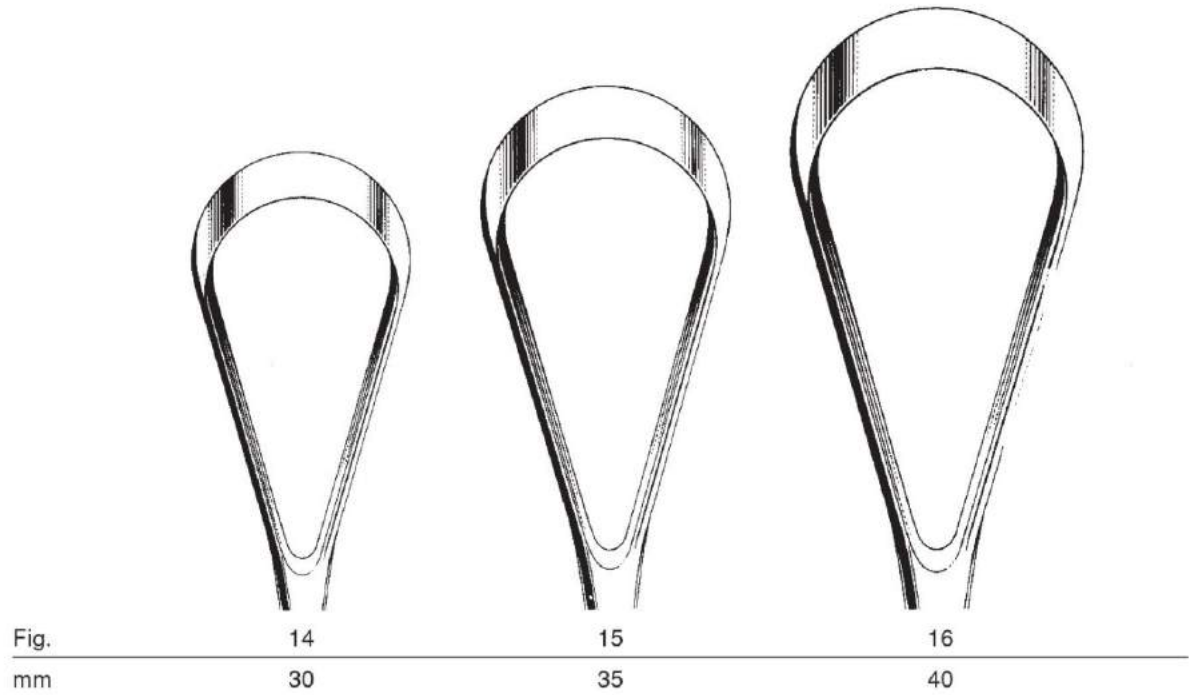
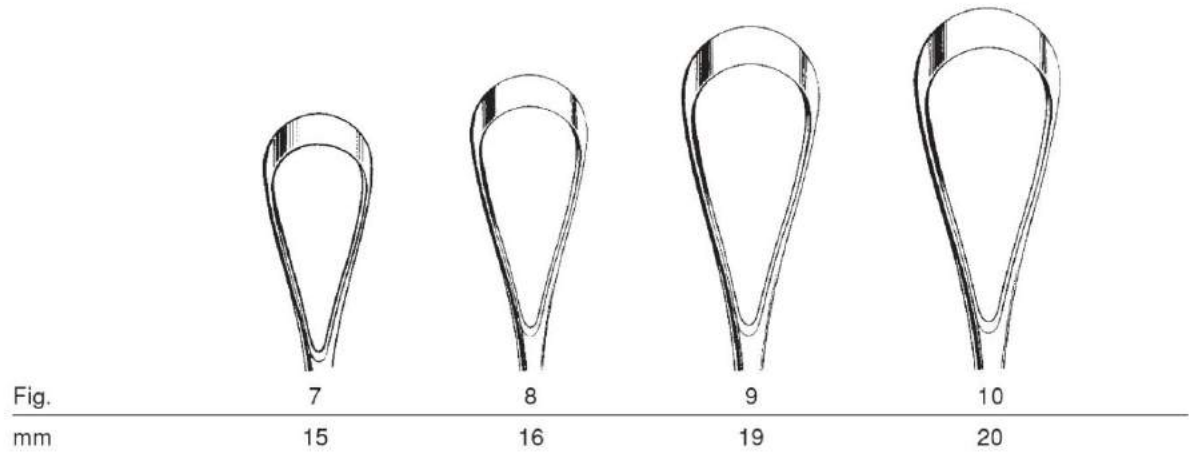
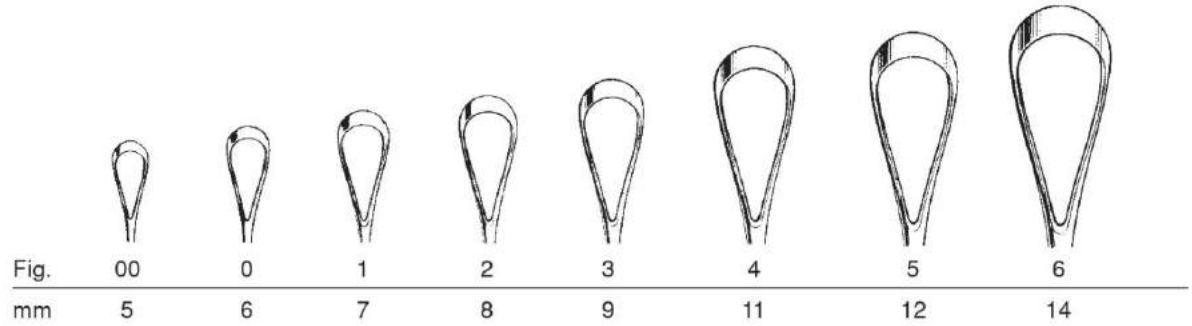

SIMS  
RECAMIER  
BUMM  
78-710-05 to 78-737-40



Uterine Curettes  
Curetas uterinas



THOMAS  
28 cm, 11"

Blunt  
roma  
smussa

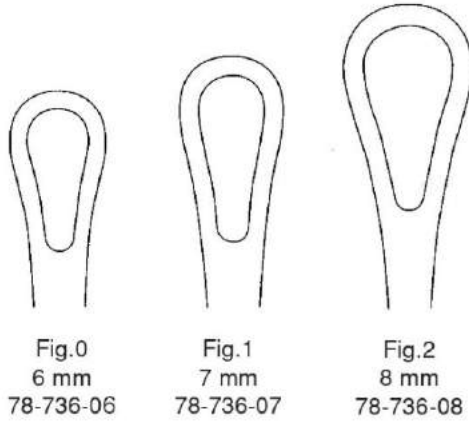

Fig.0  
6 mm  
78-736-06

Fig.1  
7 mm  
78-736-07

Fig.2  
8 mm  
78-736-08

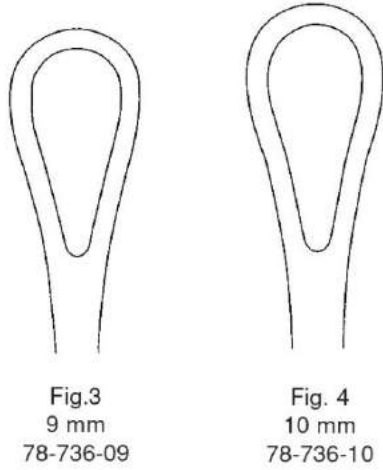

Fig.3  
9 mm  
78-736-09

Fig. 4  
10 mm  
78-736-10

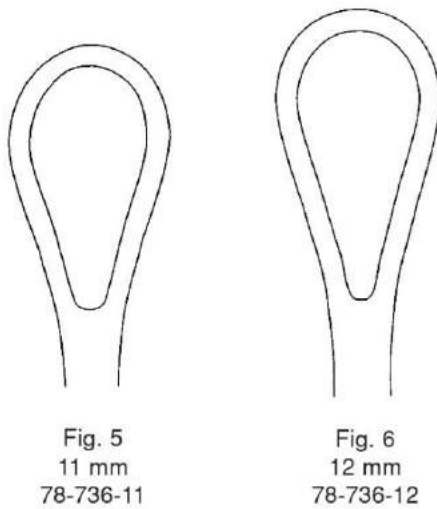
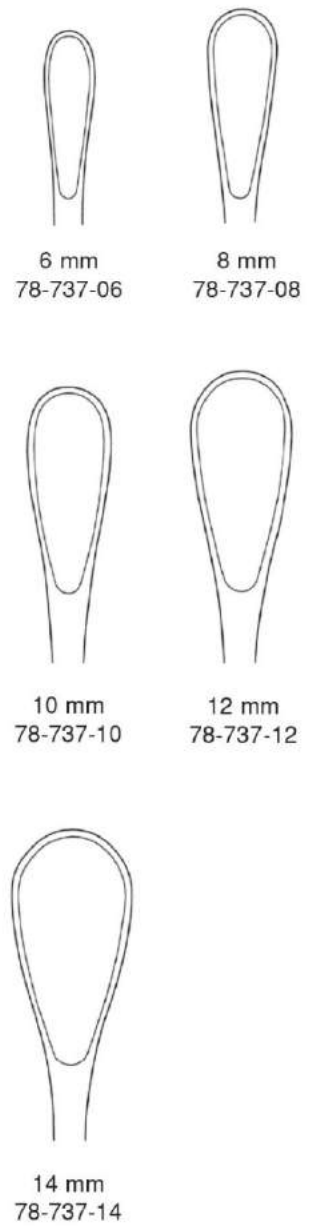

Fig. 5  
11 mm  
78-736-11

Fig. 6  
12 mm  
78-736-12



GOURDET  
28 cm, 11"



6 mm  
78-737-06

8 mm  
78-737-08

10 mm  
78-737-10

12 mm  
78-737-12

14 mm  
78-737-14



## Specimen and Aspirating Curettes, Hose Connector Curetas para biopsia y aspiración, Pieza conexión para tubos

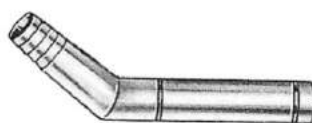
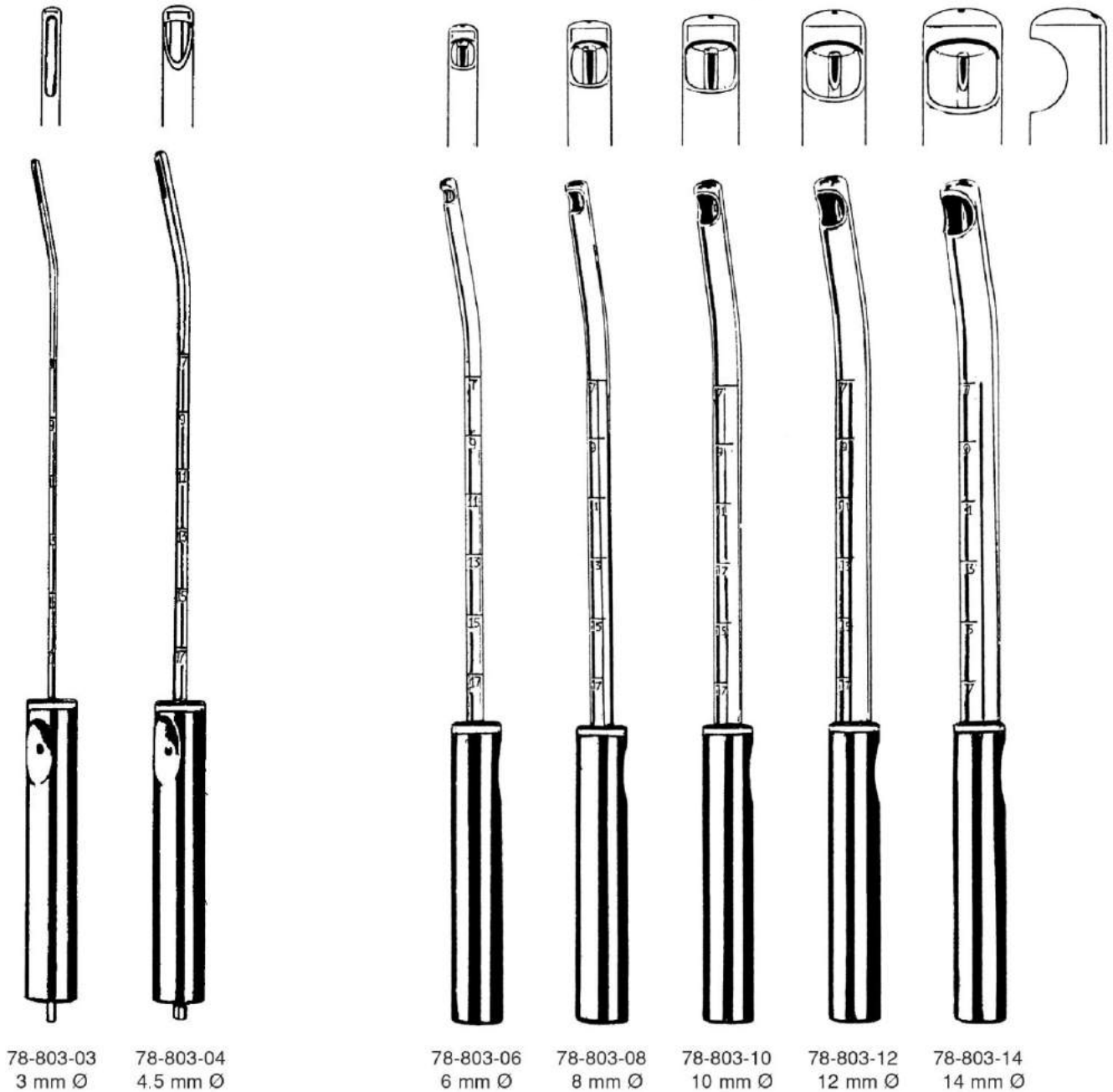

78-803-15





78-810-12 12 x 24 mm Ø 20 cm, 8"  
78-810-16 16 x 24 mm Ø 20 cm, 8"  
78-810-20 20 x 24 mm Ø 20 cm, 8"



78-810-50  
Cold Light Clamp  
Adaptados de iluminacion  
Adattore di illuminazione



## Obstetrical Forceps Forceps obstétricos



WRIGLEY  
82-101-23  
23 cm, 9"



SIMPSON  
82-102-30  
30 cm, 11 3/4"



SIMPSON-BRAUN  
82-105-33 33 cm, 13"  
82-105-36 36 cm, 14"



De LEE  
82-107-30  
30 cm, 11 3/4"



De LEE  
82-108-36 36 cm, 14"  
82-108-39 39 cm, 15.4"

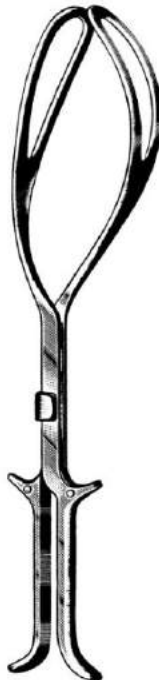

KIELLAND  
82-110-41  
41 cm, 16"



ELLIOT  
82-115-32 32 cm, 12 3/4"  
82-115-38 38 cm, 15"

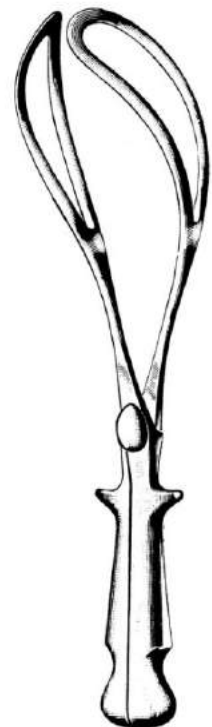

NAEGELE  
82-119-36 36 cm, 14"  
82-119-40 40 cm, 15 3/4"



Obstetrical Forceps  
Forceps obstétricos



LUIKART  
82-125-40  
40 cm, 15 3/4"



KIELLAND-LUIKART  
82-127-40  
40 cm, 15 3/4"



SIMPSON-LUIKART  
82-135-36  
36 cm, 14"

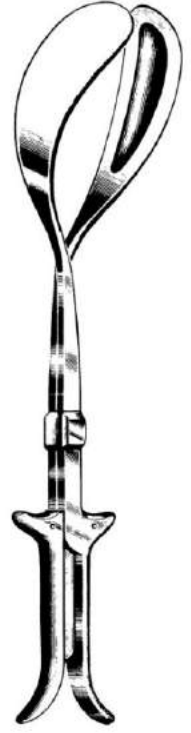

McLEAN-TUCKER-LUIKART  
82-139-40  
40 cm, 15 3/4"



McLEAN-TUCKER  
82-141-39  
39 cm, 15.4"



McLEAN-LUIKART  
82-143-39  
39 cm, 15.4"



McLEAN  
82-145-36  
36 cm, 14"

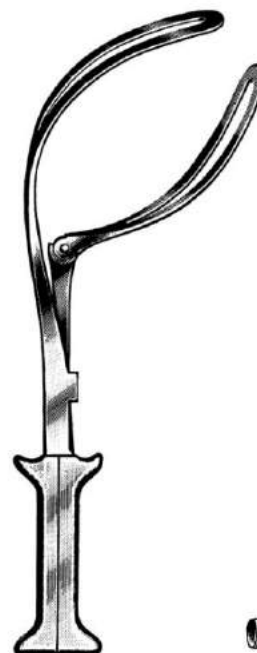

BARTON  
82-147-36  
36 cm, 14"

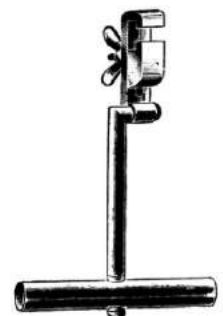

BARTON  
82-148-17  
17 cm, 6 3/4"



Obstetrical Forceps, Traction Handles  
 Forceps obstétricos, Dispositivos de tracción



BOERMA  
 82-151-29  
 29 cm, 11.4"

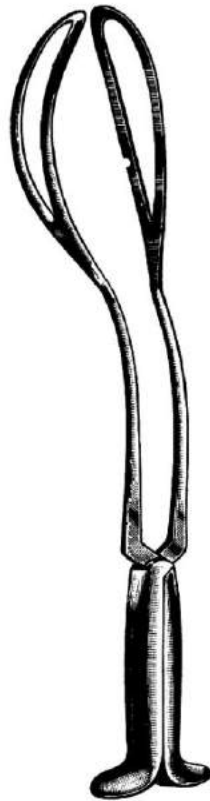

PIPER  
 82-155-44  
 44 cm, 17 1/4"



PIPER  
 82-157-40  
 40 cm, 15 3/4"

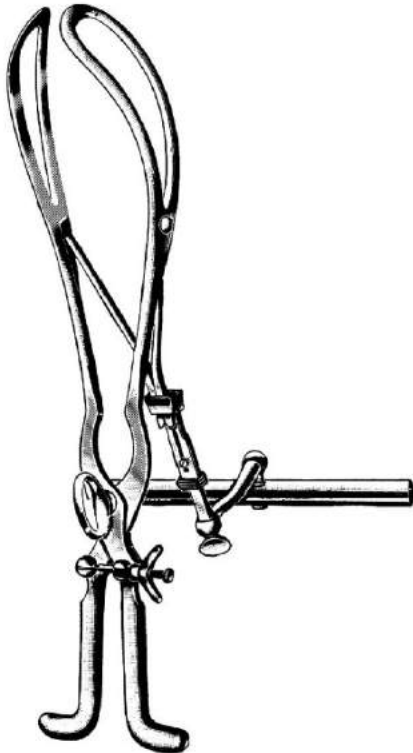

TARNIER  
 82-162-40  
 40 cm, 15 3/4"

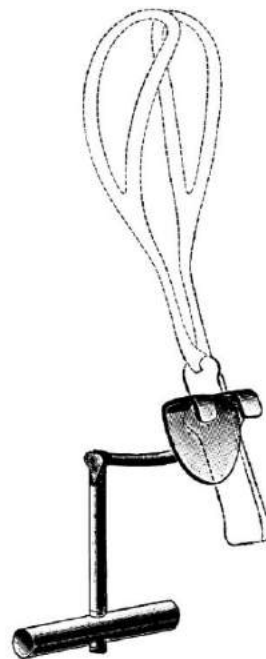

BILL  
 82-170-21  
 21 cm, 8 1/4"



LUIKART-BILL  
 82-171-21  
 21 cm, 8 1/4"



Obstetrical Instruments, Umbilical Cord Clamps, Pelvimeters  
Pinzas para cuero cabelludo, Pinzas-clamps uterinas para hemóstasis, Clamp umbilical, Pelvímetros



**SMELLIE**  
82-181-33  
33 cm, 13"

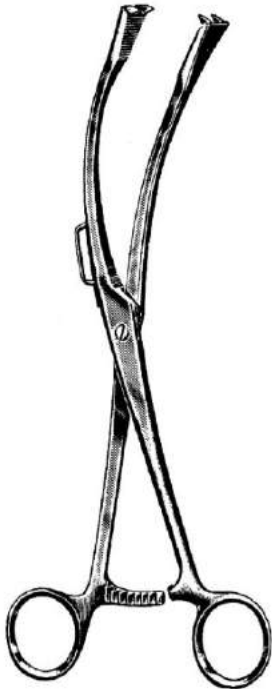

**GAUSS**  
82-183-27  
27 cm, 10 1/2"

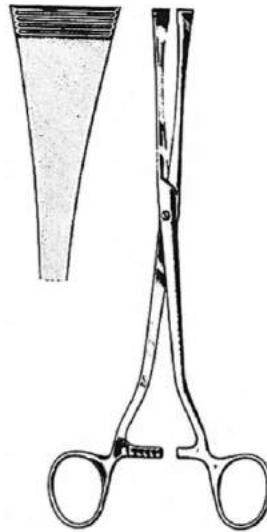

**GREEN-ARMYTAGE**  
82-184-21  
21 cm, 8 1/4"



**COLLIN**  
82-187-09  
9 cm, 3 1/2"

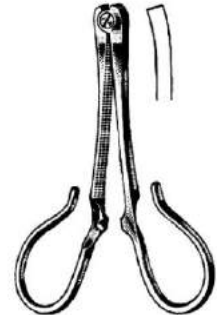

**KANE**  
82-189-09  
8.5 cm, 3.4"



**MARTIN**  
82-191-34  
34 cm, 13.4"

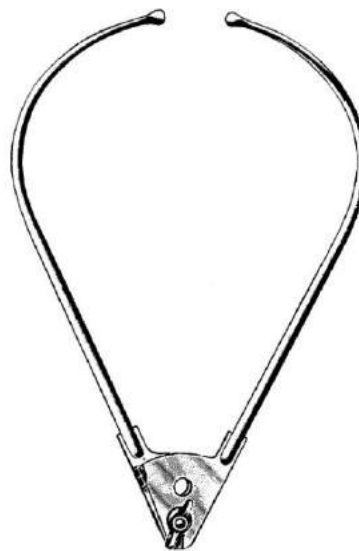

**COLLIER**  
82-193-30  
30 cm, 11 3/4"



**COLLIN**  
82-195-35  
35 cm, 13.8"



## Obstetrical Instruments Pinzas para aborto, Cucharillas para aborto

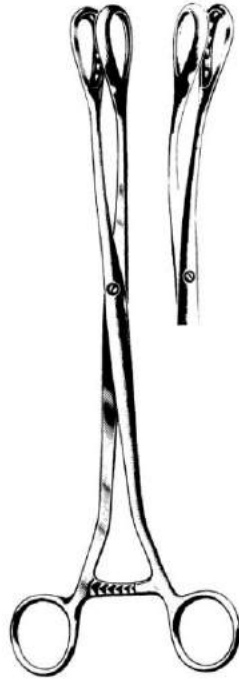

SAENGER

82-242-27 82-243-27  
27 cm, 10 1/2"

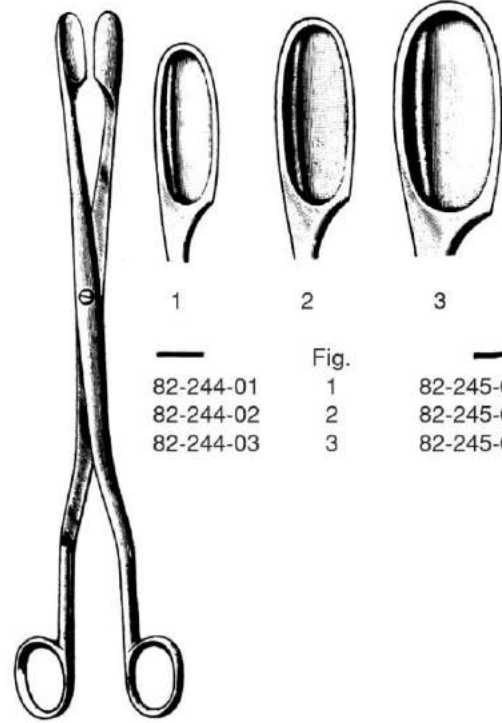

WINTER

82-244-01 to 82-245-03  
28 cm, 11"

	Fig.	
82-244-01	1	82-245-01
82-244-02	2	82-245-02
82-244-03	3	82-245-03

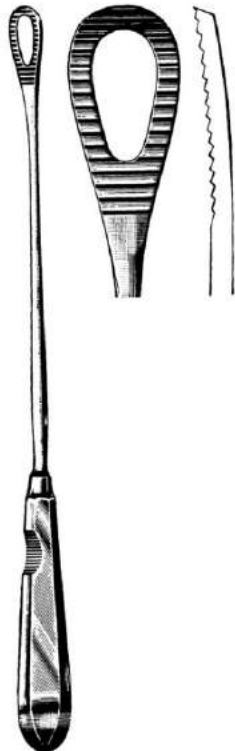

PESTALOZZA

82-252-30  
30 cm, 11 3/4"

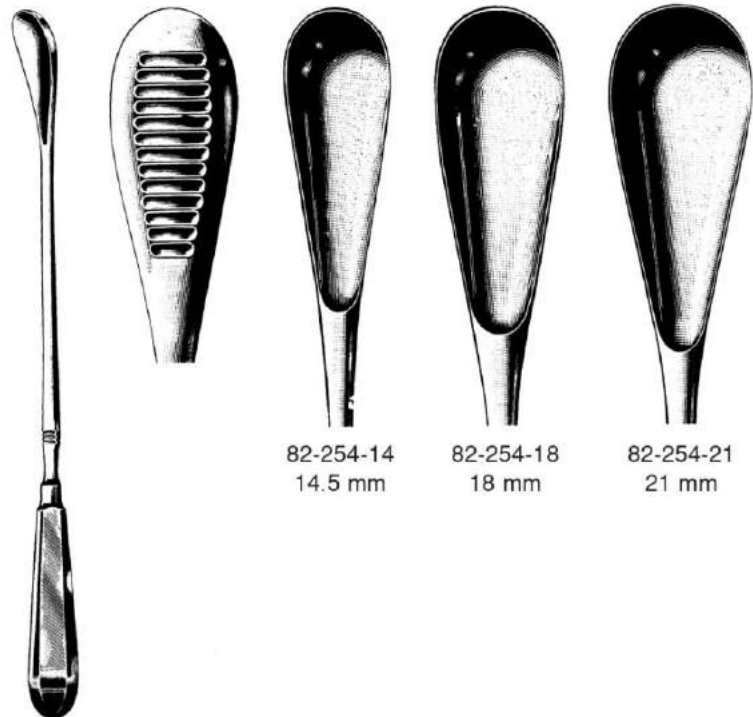

CUZZI

82-254-14 to 82-254-21  
30 cm, 11 3/4"

82-254-14	82-254-18	82-254-21
14.5 mm	18 mm	21 mm



## Obstetrical Instruments Separador obstetrico, Craneoclasto, Basiotribo, Perforacráneos

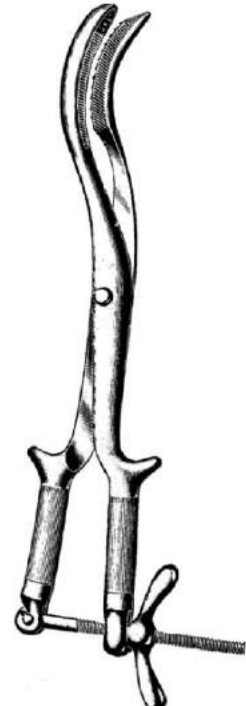

WALLICH  
82-256-42  
42 cm, 16 1/2"

SELLHEIM  
82-259-28  
28 cm, 11"

BRAUN  
82-302-42  
42 cm, 16 1/2"

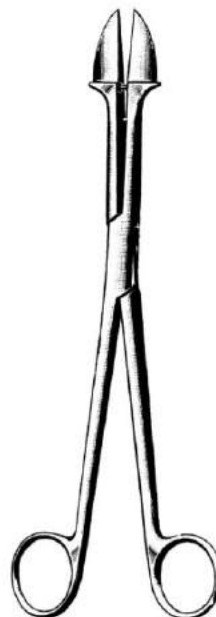
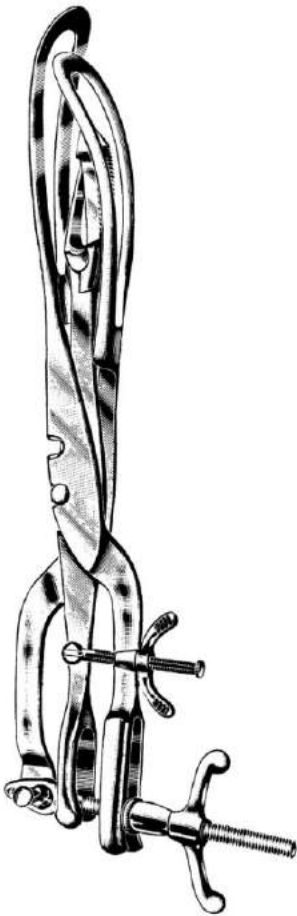

TARNIER  
82-304-46  
46 cm, 18"

SPELLIE  
82-306-25  
25 cm, 10"

BRAUN  
82-309-30  
30 cm, 11 3/4"



Skin Hook, Comedone Extractors, Lupus Currettes, Skin Currettes, Cutaneous Punches  
 Ganchos cutáneos, Saca comedones, Curetas para lupus, Curetas cutáneas, Trépanos cutáneos



**KILNER**  
 86-103-15  
 15 cm, 6"



**SCHAMBERG**  
 86-111-10  
 10 cm, 4"



**UNNA**  
 86-113-14  
 14 cm, 5 1/2"



**UNNA**  
 86-115-14  
 14 cm, 5 1/2"



**WALTON**  
 86-118-14  
 14 cm, 5 1/2"



**SAALFELD**  
 86-121-10  
 10 cm, 4"

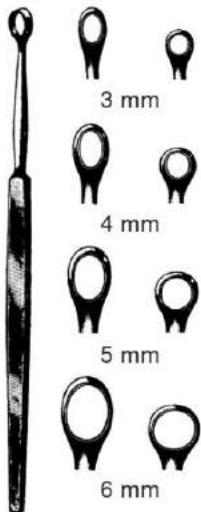

<b>PIFFARD Oval</b>	<b>FOX Round</b>
86-128-01 1 mm	86-129-01 1 mm
86-128-02 2 mm	86-129-02 2 mm
86-128-03 3 mm	86-129-03 3 mm
86-128-04 4 mm	86-129-04 4 mm
86-128-05 5 mm	86-129-05 5 mm
86-128-06 6 mm	86-129-06 6 mm

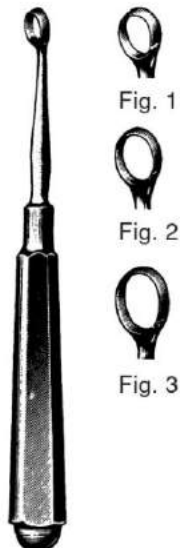

**PIFFARD**  
 86-130-01 Fig. 1  
 86-130-02 Fig. 2  
 86-130-03 Fig. 3

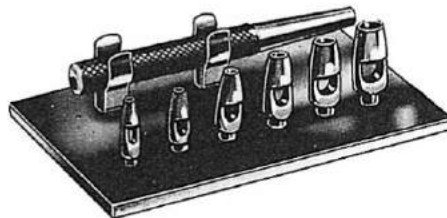

**86-138-00**  
**KEYES Biopsy Punch**  
 Set Complete With 6 Heads  
 Juego con 6 puntas  
 Serie completa con 6 trefini

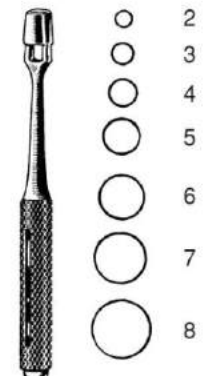

**KEYES**  
 86-140-02 2 mm  
 86-140-03 3 mm  
 86-140-04 4 mm  
 86-140-05 5 mm  
 86-140-06 6 mm  
 86-140-07 7 mm  
 86-140-08 8 mm





Nurse Set  
86-301-10

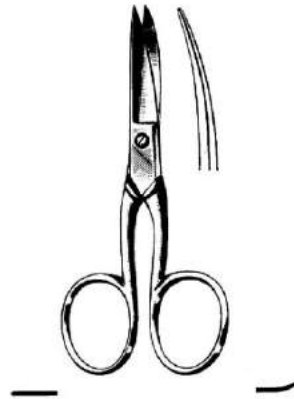

NAIL SCISSORS  
86-304-10 10 cm, 4" 86-305-10



NAIL NIPPER ANGLED  
86-331-14  
14 cm, 5 1/2"  
Stainless



TURNBULL  
86-341-11 11.5 cm, 4 1/2"  
86-341-13 13.5 cm, 5 1/4"  
Stainless



Cuticle Nipper, Cuticle Scissors, Nail Files  
Pinzas y Tijeras cuticulares, Limas para uñas



CUTICLE NIPPER  
86-373-10  
10.5 cm, 4.1"

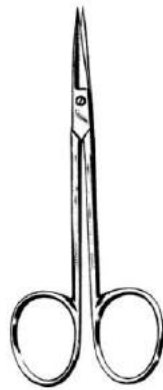

CUTICLE SCISSORS  
86-378-10  
10 cm, 4"

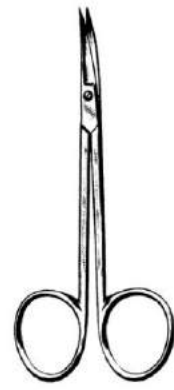

CUTICLE SCISSORS  
86-379-10  
10 cm, 4"



86-382-16



86-386-10 10 cm, 4"  
86-386-12 12 cm, 4<sup>3</sup>/<sub>4</sub>"



## Brush Dispenser, Nail Brushes Distribuidores de cepillos, Cepillo para unas

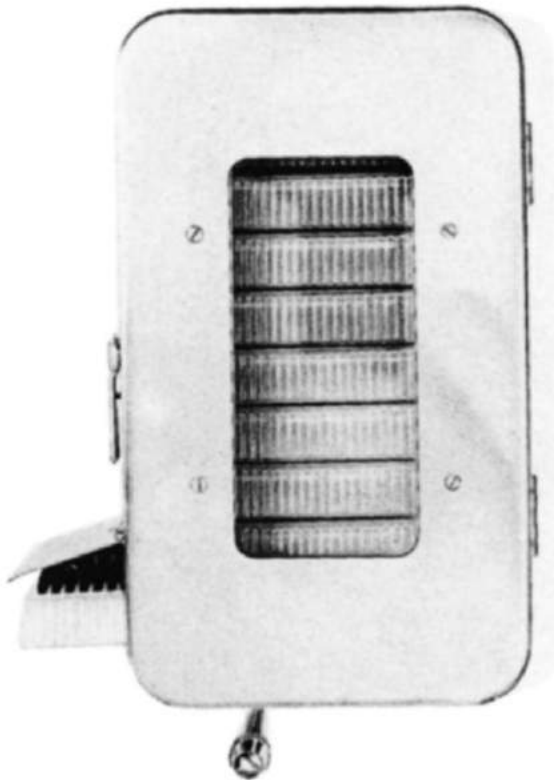

86-396-01  
Brush Dispenser for 10 Brushes  
Distribuidor de cepillos para 10 cepillos  
Distributore per spazzolini da 10

86-396-02  
Brush dispenser for 20 brushes  
Distribuidor de cepillos para 20 cepillos  
Distributore per spazzolini da 20

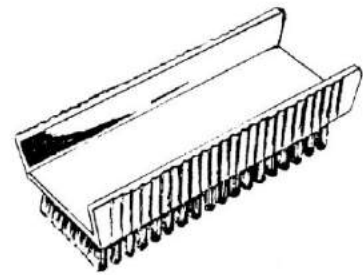

86-397-00

Box of 10 Brushes  
caja de 10 pzas.  
confezione da 10 pezzi



PROBE AND PACKER  
86-450-00



SPATULA AND PACKER  
86-440-00



Nail Curette D/E  
With Hole,  
con agujero, con foro

86-430-12 1.5 mm & 2 mm  
86-430-13 1.5 mm & 2.5 mm



Nail Curette S/E  
Without Hole,  
sin agujero, senza foro  
86-400-01 1 mm  
86-400-02 1.5 mm  
86-400-03 2 mm  
86-400-04 2.5 mm

Nail Curette S/E  
With Hole,  
con agujero, con foro  
86-410-01 1 mm  
86-410-02 1.5 mm  
86-410-03 2 mm  
86-410-04 2.5 mm



**Nail Nippers and Splitters**  
**Alicates corta-uñas**



86-450-13  
Concave



86-450-13 86-460-13  
13 cm, 5 1/8"



86-460-13  
Straight  
recto  
retta

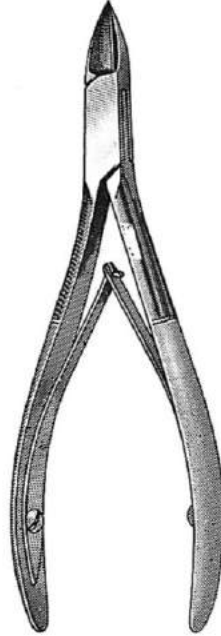

86-470-11  
10 cm  
4"



86-475-11  
11.5 cm  
4 1/2"

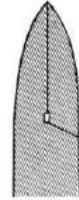

86-480-13  
12,5 cm  
5"



Fine  
86-485-13  
12.5 cm  
5"



86-490-15  
15 cm  
6"

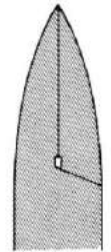

Fine  
86-500-15  
15 cm  
6"

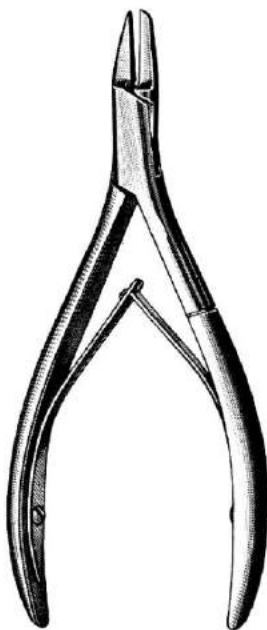

ENGLISH ANVIL  
86-550-13  
13 cm, 5 1/8"



CUTICLE NIPPER  
86-600-10  
10 cm, 4"

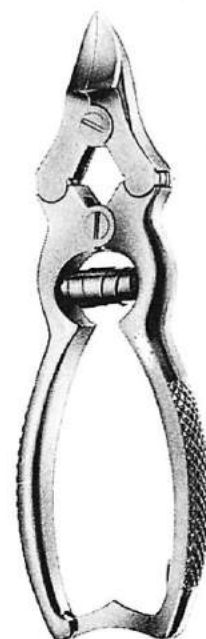

DOUBLE ACTION CONCAVE  
86-620-15  
15 cm, 6"

Nail Nipper, Nail Scissors  
Alicates corta-uñas, Tijeras para uñas



86-630-12  
12 cm, 4<sup>3</sup>/<sub>4</sub>"



86-640-15  
15 cm, 6"

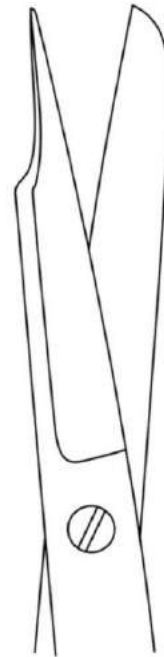

Nail Splitting Scissors  
Tijeras para hender uñas  
Forbici per staccare unghie



## Needle Sterilizing Cases, Sterilizing Forceps Estuches para esterilizar agujas, Combinacion tapa-pinza

18/10  
Stainless Steel  
Acero inoxidable  
Acciaio inossidabile



**SAUERBRUCH**  
90-110-21  
210 x 125 x 17 mm

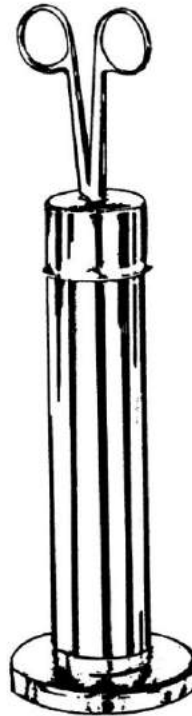

90-111-25 25 cm, 10"  
90-111-32 32 cm, 12<sup>3</sup>/<sub>4</sub>"

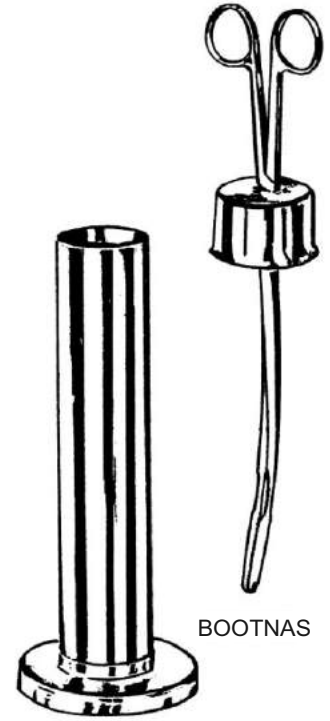

**BOOTNAS**

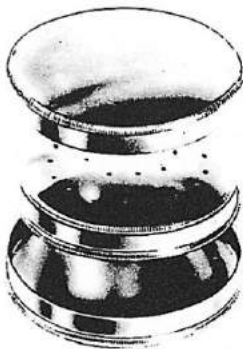

90-112-65  
65 x 15 mm



90-113-65

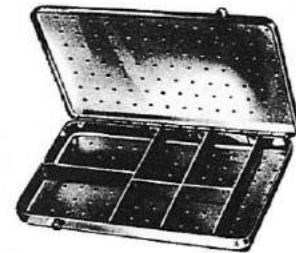

90-114-00  
150 x 95 x 13 mm



90-115-50 50 x 25 x 4.5 mm  
90-115-65 65 x 42 x 8.0 mm  
90-115-75 75 x 25 x 4.5 mm



90-116-50 50 x 25 x 4.5 mm  
90-116-65 65 x 42 x 8.0 mm  
90-116-75 75 x 25 x 4.5 mm

Sterilization Cases  
Cajas para esterilización



90-117-20 200 x 100 x 25 mm  
90-117-23 230 x 130 x 25 mm  
90-117-27 275 x 230 x 25 mm

Micro Instrument Tray with Silicone Mat  
Caja para instrumental micro-quirurgico con alfombrilla de silicona  
Scatola per sterilizzazione con stuoia in silicone

90-118-20  
90-118-23  
90-118-27

Silicone Mat  
Alfornbrilla de silicona  
Stuoia in silicone



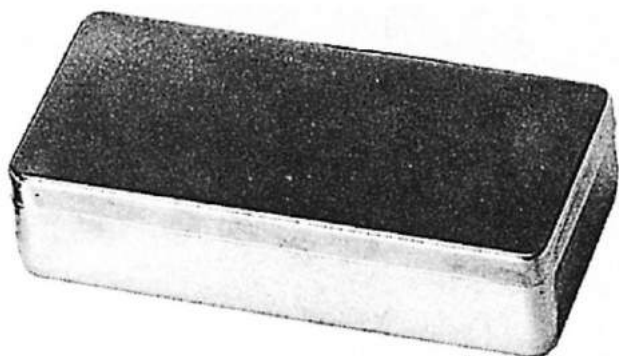

Sizes in mm  
tamaños en mm  
misura in mm

Lid without knob  
tapa sin botón  
coperchio senza bottone

165 x 85 x 35  
218 x 150 x 50  
260 x 150 x 50  
310 x 200 x 50

90-122-16  
90-122-21  
90-122-26  
90-122-30



Cotton dispensers

	Ø x H
90-123-10	75x0060 mm
90-123-11	75x0075 mm
90-123-12	100x060 mm
90-123-13	100x100 mm
90-123-14	125x080 mm
90-123-15	125x125 mm
90-123-16	150x150 mm



Kidney bowls

	L x B x H
90-121-17	170x100x30 mm
90-121-20	200x120x35 mm
90-121-25	250x140x40 mm
90-121-27	275x150x50 mm
90-121-30	300x160x50 mm
90-121-40	400x200x60 mm



## Sterilization Cases Cajas para esterilización



Sizes in mm L x W x H  
tamaños en mm (l x f x a)  
misura in mm (l x l x a)

230 x 130 x 50 9" x 5" x 2"  
260 x 150 x 50 10" x 6" x 2"  
275 x 235 x 50 11" x 9" x 2"  
300 x 200 x 50 12" x 8" x 2"  
325 x 275 x 50 13" x 11" x 2"  
420 x 175 x 50 16" x 7" x 2"

230 x 130 x 75 9" x 5" x 3"  
260 x 150 x 75 10" x 6" x 3"  
275 x 235 x 75 11" x 9" x 3"  
300 x 200 x 75 12" x 8" x 3"  
325 x 275 x 75 13" x 11" x 3"  
420 x 175 x 75 16" x 7" x 3"

Containers  
Recipientes  
Recipienti

90-124-23  
90-124-26  
90-124-27  
90-124-30  
90-124-32  
90-124-42

90-125-23  
90-125-26  
90-125-27  
90-125-30  
90-125-32  
90-125-42

Set of Special Filters 5 pairs  
Juego de filtros especiales (5 pares)  
Set die 5 paia di filtri speciali

90-126-23  
90-126-26  
90-126-27  
90-126-30  
90-126-32  
90-126-42

90-127-23  
90-127-26  
90-127-27  
90-127-30  
90-127-32  
90-127-42



## Trays, Bowls Bandejas

1 Liter = 33.8 oz  
 1.5 oz = 50 ml  
 2 oz = 75 ml  
 3 oz = 100 ml  
 4 oz = 150 ml

18/10  
 Stainless Steel  
 Acero inoxidable  
 Acciajo inossidabile

Satin Finish  
 pulidas mate  
 opaco



Sizes in mm Tamaños en mm misura in mm Ø x h	Capacity capacidad capacità Liter	
40 x 19	0.05	90-127-04
61 x 30	0.07	90-127-06
80 x 40	0.14	90-127-08
116 x 50	0.35	90-127-11
128 x 55	0.45	90-127-12
147 x 65	0.70	90-127-14
167 x 75	1.10	90-127-16
187 x 85	1.60	90-127-18



90-129-11

Sizes in mm Tamaños en mm misura in mm Ø x h	Capacity capacidad capacità Liter
110 x 28	0.15

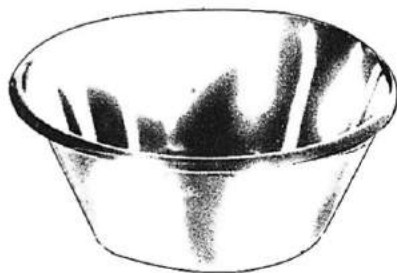

	mm	Liter
90-133-16	165 x 60	0.75
90-133-17	175 x 70	1.00
90-133-22	220 x 80	2.00
90-133-23	225 x 90	2.50
90-133-24	240 x 110	3.00
90-133-25	255 x 115	4.00
90-133-27	275 x 115	4.50
90-133-31	310 x 120	6.00
90-133-34	345 x 125	8.50
90-133-38	380 x 130	11.00

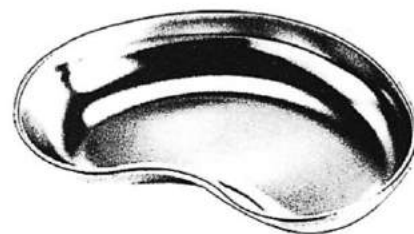

90-139-17	170 x 100 x 35 mm	0.50 Liter
90-139-25	250 x 140 x 40 mm	1.25
90-139-27	275 x 150 x 45 mm	2.25



## Travs. Bowls



Liter	
0.25	90-140-02
0.5	90-140-05
1.0	90-140-10
2.0	90-140-20

18/10  
Stainless Steel  
Acero inoxidable  
Acciajo inossidabile

Satin Finish  
pulidas mate  
opaco



90-141-10  
100 x 20 mm



	W x H mm
90-142-01	30 x 90
90-142-02	50 x 100
90-142-03	50 x 130
90-142-04	50 x 175
90-142-05	75 x 100
90-142-06	75 x 130
90-142-07	75 x 175

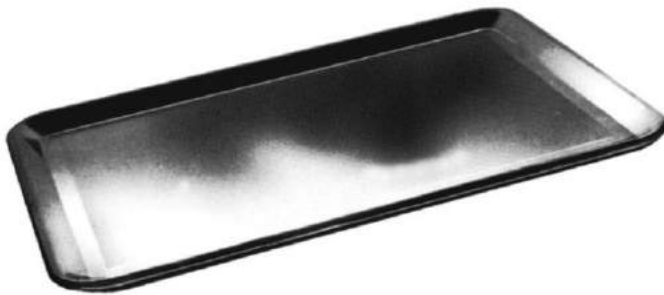

90-147-21 to 90-147-42

	L x W x H
90-147-21	210 x 160 x 10 mm
90-147-24	240 x 180 x 10 mm
90-147-30	310 x 150 x 10 mm
90-147-31	310 x 210 x 10 mm
90-147-35	350 x 240 x 10 mm
90-147-40	400 x 270 x 20 mm
90-147-42	420 x 280 x 10 mm



90-145-20 to 90-145-42

### Instrument Trays

	L x B x H
90-145-20	200x150x25 mm
90-145-22	230x155x30 mm
90-145-28	300x175x30 mm
90-145-31	300x175x40 mm
90-145-32	300x200x50 mm
90-145-35	350x220x40 mm
90-145-37	400x300x50 mm
90-145-42	450x350x50 mm



Medicine Spoon and Cups, Trays for Tablets, Sputum Cup  
Cuchara graduada, Vasos graduados, Platos para tabletas, Escupidera

1 oz = 29.5 cc



90-147-10 100 cc  
90-147-25 250 cc



90-148-25 25 cc  
90-148-50 50 cc

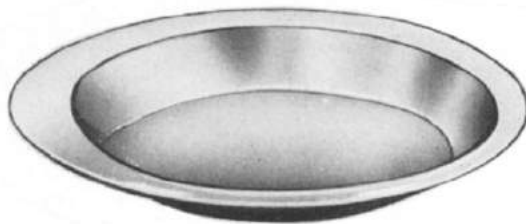

90-149-13 110 x 13 mm  
90-149-20 95 x 20 mm



90-150-30  
90 x 80 mm



## Sterilizing Drums, Sterilization Trays Tambores p. esterilización, Cestas de esterilización



### SCHIMMELBUSCH

Ø

mm

90-152-08	125 x 80
90-152-10	125 x 100
90-152-12	125 x 125
90-155-08	150 x 80
90-155-10	150 x 100
90-155-13	150 x 130
90-155-15	150 x 150
90-155-19	150 x 190
90-159-14	190 x 145
90-159-16	190 x 165
90-159-19	190 x 190
90-159-24	190 x 240
90-164-14	240 x 145
90-164-16	240 x 165
90-164-19	240 x 190
90-164-24	240 x 240
90-164-29	240 x 290
90-164-34	240 x 340
90-164-39	240 x 390
90-169-14	290 x 145
90-169-16	290 x 165
90-169-19	290 x 190
90-169-24	290 x 240
90-169-29	290 x 290
90-169-34	290 x 340
90-169-39	290 x 390
90-174-14	340 x 145
90-174-16	340 x 165
90-174-19	340 x 190
90-174-24	340 x 240
90-174-29	340 x 290
90-174-34	340 x 340
90-174-39	340 x 390
90-179-14	390 x 145
90-179-16	390 x 165
90-179-19	390 x 190
90-179-24	390 x 240
90-179-29	390 x 290
90-179-34	390 x 340
90-179-39	390 x 390
90-179-49	390 x 490
90-179-59	390 x 590

18/10

Stainless Steel  
Acero inoxidable  
Acciajo inossidabile  
Acciaio inossidabile

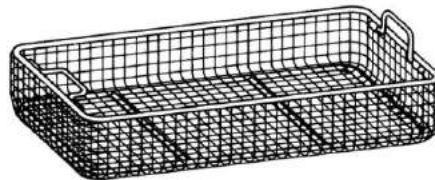

90-230-05	240 x 250 x 50 mm
90-230-07	240 x 250 x 70 mm
90-231-05	240 x 254 x 50 mm
90-232-05	480 x 250 x 50 mm
90-232-07	480 x 250 x 70 mm
90-232-10	480 x 250 x 100 mm
90-233-05	480 x 254 x 50 mm
90-234-05	510 x 254 x 50 mm



## Trays Bandejas

Perforated Sheet Metal  
De chapa de acero perforada  
In acciaio perforato

18/10  
Stainless Steel  
Acero inoxidable  
Acciaio inossidabile

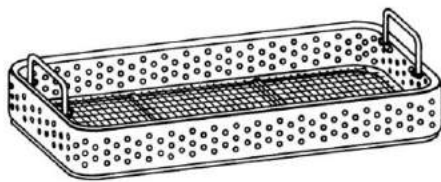

Basket tray with perforated wall, folding handle  
Bandeja metálica perforada con asas plegables  
Cestelli in acciaio perforato con maniglie mobile

90-240-06 240 x 250 x 60 mm  
90-241-06 480 x 250 x 60 mm

	mm x mm x mm
90-250-10	240 x 240 x 50
90-250-20	240 x 240 x 80
90-250-30	240 x 240 x 100
90-250-40	480 x 260 x 50
90-250-50	520 x 260 x 80
90-250-60	520 x 260 x 100

Label Holder  
Soporte p. placas  
Supporto per targhette

90-242-25 50 x 25 mm

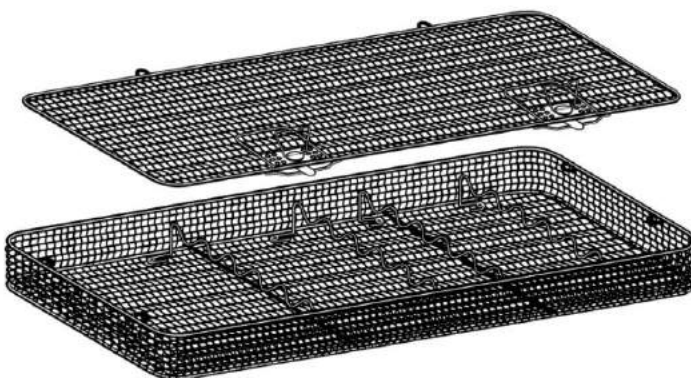

For Cold Light Cables  
para cables de luz fría  
per cavi a fibre/ottiche  
90-255-60 420 x 250 x 60 mm

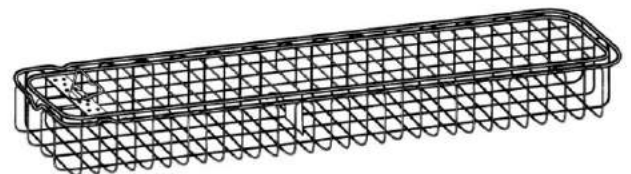

For 1 Endoscope,  
para 1 endoscopio, per 1 endoscopio  
90-256-29 290 x 80 x 52 mm  
90-256-46 460 x 80 x 52 mm  
90-256-67 670 x 80 x 52 mm

For 2 Endoscopes,  
para 2 endoscopios, per 2 endoscopi rigidi  
90-257-46 460 x 80 x 52 mm



Tubing Clamp, Decimal Spring Caliper, Forceps Holder  
 Pinzas para tubos, calibrador decimal, Cadres de esterilizacion

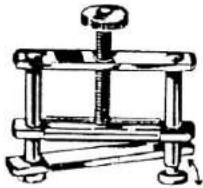

**HOFFMAN**  
 90-260-13 13 mm  
 90-260-17 17 mm  
 90-260-20 20 mm  
 90-260-25 25 mm  
 90-260-30 30 mm  
 90-260-40 40 mm



**SIMPLEX**  
 90-265-12

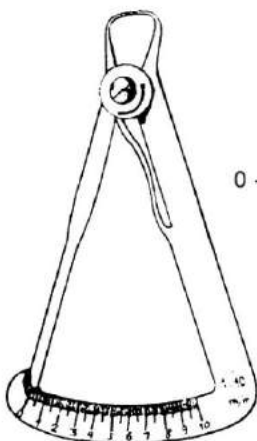

0 - 10 mm

**IWANSON**  
 90-270-15



**BUNT**  
 34-150-12  
 12 cm, 4<sup>3</sup>/<sub>4</sub>"

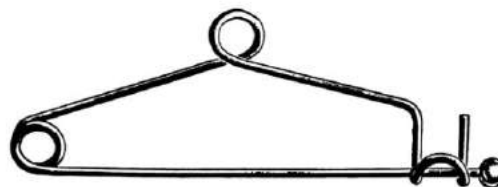

**MAYO**  
 34-152-14  
 14 cm, 5<sup>1</sup>/<sub>2</sub>"



## Stainless Steel Perforated Sheet Baskets Bandejas en acero inoxidable

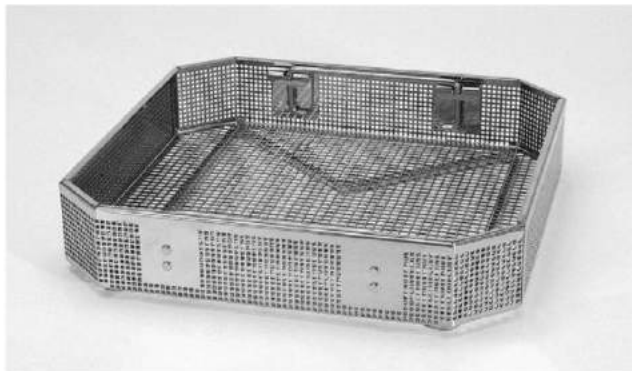

- Stainless steel perforated sheet baskets
- Paniers en tôle perforée inox
- Cestelli in lamiera forata inox

90-421-50	mm	210	145	50
90-424-45	mm	240	240	45
90-424-50	mm	240	240	50
90-424-70	mm	240	240	70
90-424-90	mm	240	240	90
90-424-41	mm	240	240	41
90-424-51	mm	240	300	50
90-440-45	mm	400	240	45
90-440-50	mm	400	240	50
90-440-70	mm	400	240	70
90-440-90	mm	400	240	90
90-440-41	mm	400	240	41
90-448-45	mm	480	240	45
90-448-50	mm	480	240	50
90-448-70	mm	480	240	70
90-448-90	mm	480	240	90
90-448-41	mm	480	240	41
90-454-45	mm	540	240	45
90-454-50	mm	540	240	50
90-454-70	mm	540	240	70
90-454-90	mm	540	240	90
90-454-41	mm	540	240	41
90-428-40	mm	280	110	40
90-428-70	mm	280	110	70

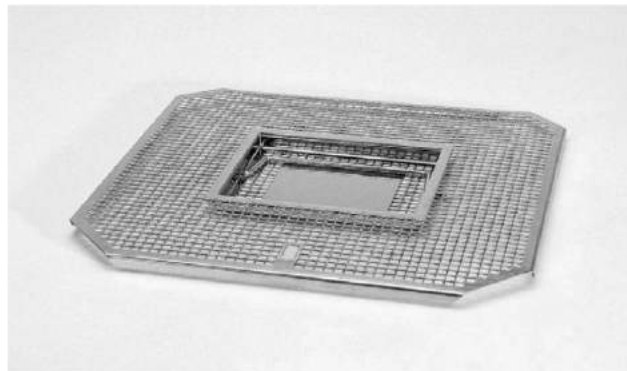

- Stainless steel covers for baskets made of perforated stainless steel sheet
- Couverdes inox pour paniers en tôle percée inox
- Coperchi inox per cestelli in lamiera forata inox

90-424-24	mm	240	240
90-424-30	mm	240	300
90-440-24	mm	400	240
90-448-24	mm	480	240
90-454-24	mm	540	240



## Water Jet Pistol Pistola-lavatora



90-500-00  
Complete with 9 Tips  
con 9 toberas  
completa con 9 raccordi

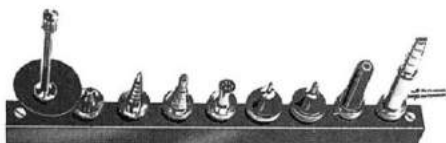

90-500-12  
Pistol Only  
Pistola sola  
Pistola sola

90-500-06  
Cleansing Tip for Hypodermic Needles with Record Cone  
Tobera para agujas de inyección con cono Record  
Raccordo di lavaggio per aghi ipodermici con cono Record



90-500-07  
Cleansing Tip for Hypodermic Needles with Luer Cone  
Tobera para agujas de inyección con cono Luer  
Raccordo di lavaggio per aghi ipodermici con cono Luer



90-500-08  
Cleansing Tip for Meas. and Volumetric Pipettes  
Tobera para pipetas de medida y volumétricas  
Raccordo di lavaggio per pipette comuni e graduate



90-500-09  
Cleansing Tip for Fine Pipettes  
Tobera para pipetas finas  
Raccordo di lavaggio per pipette fine



90-500-01  
Cleansing Tip for Bottles  
Tobera para botellas  
Raccordo di lavaggio per bottiglie



90-500-02  
Cleansing Tip for Cones of Record Syringes  
Tobera para conos de jeringas Record  
Raccordo per coni di siringhe Record



90-500-03  
Cleansing Tip for Catheters  
Tobera para catéteres  
Raccordo di lavaggio per cateteri



90-500-04  
Cleansing Tip for Drainage Tubings  
Tobera para tubos de drenaje  
Raccordo di lavaggio per tubi di drenaggio



90-500-05  
Cleansing Tip for Receptacles (Shower)  
Tobera para recipientes (ducha)  
Raccordo di lavaggio per recipienti (doccia)



90-500-10  
Cleansing Tip 31 cm, 12 1/4" Straight  
Tobera 31 cm, 12 1/4" recta  
Raccordo 31 cm, 12 1/4" rette



90-500-11  
Cleansing Tip 30 cm, 11 3/4" Curved  
Tobera 30 cm, 11 3/4" curva  
Raccordo di lavaggio 30 cm, 11 3/4" curvo

90-501-03  
Couplings for Connection to Water Tap  
Tuercas-hembras para conexión al grifo de agua  
Dadi premistoppa per connessione ai rubinetti filettati





## High Frequency Surgery Electrocirugía

Minimum Order Quantity 10 Each  
Cantidad mínima 10



94-010-01  
Fig. 1



94-010-02  
Fig. 2 45°



94-010-03  
Fig. 3 120°



94-010-11  
Fig. 11  
Ø 3 mm



94-010-12  
Fig. 12  
Ø 5 mm



94-010-13  
Fig. 13  
Ø 8 mm



94-010-14  
Fig. 14



94-010-15  
Fig. 15 45°  
7.0 x 1.5 mm



94-010-16  
Fig. 16 45°  
7 mm



94-010-17  
Fig. 17  
6.0 x 1.3 mm



94-010-18  
Fig. 18 30°  
7.0 x 1.7 mm



94-010-21  
Fig. 21  
7.0 x 1.7 mm



94-010-31  
Fig. 31 45°  
Ø 0.6 mm



94-010-33  
Fig. 33 45°  
Ø 1.7 mm



94-010-34  
Fig. 34 45°  
Ø 3.0 mm



94-010-35  
Fig. 35



94-010-36  
Fig. 36 90°



High Frequency Surgery  
Electrocirugia



94-011-51  
Fig. 51 45°  
Ø 3 mm



94-011-52  
Fig. 52 45°  
7.0 x 1.7 mm



94-011-53  
Fig. 53 45°



94-011-54  
Fig. 54



94-011-55  
Fig. 55



94-011-56  
Fig. 56 45°  
Ø 5 mm



94-011-61  
Fig. 61 45°



94-011-62  
Fig. 62 90°

Shaft □ 4 mm

STANDARD



94-020-01



94-020-02



94-020-03



94-020-04



Ø mm  
5 94-022-05  
10 94-022-10  
20 94-022-20



Ø mm  
10 94-024-10  
15 94-024-15  
20 94-024-20



Ø mm  
2 94-030-02  
4 94-030-04  
6 94-030-06

Shaft  
Ø 4 mm



## Bipolar Coagulation Coagulación bipolar



94-102-11  
11 cm, 4 <sup>3</sup>/<sub>8</sub>"



94-104-11  
11 cm, 4 <sup>3</sup>/<sub>8</sub>"



94-109-11  
11 cm, 4 <sup>3</sup>/<sub>8</sub>"  
45°



94-113-11  
11 cm, 4 <sup>3</sup>/<sub>8</sub>"  
45°



94-115-11  
11 cm, 4 <sup>3</sup>/<sub>8</sub>"  
45°



94-122-16  
16.5 cm, 6 <sup>1</sup>/<sub>2</sub>"



94-123-16  
16.5 cm, 6 <sup>1</sup>/<sub>2</sub>"



94-124-16  
16.5 cm, 6 <sup>1</sup>/<sub>2</sub>"  
1 mm



94-125-16  
16.5 cm, 6 <sup>1</sup>/<sub>2</sub>"



94-127-16  
16.5 cm, 6 <sup>1</sup>/<sub>2</sub>"  
1 mm



Bipolar Coagulation  
Coagulación bipolar



94-135-16  
16.5 cm, 6 1/2"



94-139-16  
16.5 cm, 6 1/2"



94-142-16  
16.5 cm, 6 1/2"



94-144-16  
16.5 cm, 6 1/2"



94-146-16  
16.5 cm, 6 1/2"  
1 mm



94-152-19  
19.5 cm, 7 3/4"



94-154-19  
19.5 cm, 7 3/4"  
1 mm



94-157-19  
19.5 cm, 7 3/4"  
1 mm



94-159-19  
19.5 cm, 7 3/4"  
2 mm



Bipolar Coagulation  
Coagulación bipolar



94-162-19  
19.5 cm, 7 3/4"  
—



94-164-19  
19.5 cm, 7 3/4"  
1 mm



94-166-19  
19.5 cm, 7 3/4"  
2 mm



94-167-19  
19.5 cm, 7 3/4"  
1 mm



94-169-19  
19.5 cm, 7 3/4"  
1 mm



94-172-03 - 94-172-12  
22.5 cm, 8.9"



94-172-03  
0.3 mm



94-172-07  
0.7 mm



94-172-12  
1.2 mm





Connection Cords  
Cables de conexión



ERBE

AESCULAP

USA Mod.

MARTIN

3 m	118"	94-190-30
5 m	197"	94-190-50

94-191-30

94-192-30
94-192-50

94-193-30
94-193-50

For Electrosurgery Equipment  
para Electrobisturios  
per Elettrobisturi



## Suggested Surgical Sets Modelos para cirugía

### GENERAL SURGERY

#### Basic Laparotomy Set

Quantity	BOOTNAS Catalog #	Description
1ea.	05-340-15	Metal Ruler Mm/Inch 15cm/6"
1ea.	07-130-10	POOLE Aspiration Tube 30 Fr 10mm
1ea.	07-150-27	YANKAUER Suction Tube Complete 27cm/10.5"
2ea.	09-103-01	Scalpel Handle No. 3
2ea.	09-104-00	Scalpel Handle No. 4
1ea.	09-107-00	Scalpel Handle No. 7
1ea.	11-110-14	Operating Scss Sharp/Blunt Str 14.5cm/5.5"
1ea.	11-160-17TC	MAYO Scss Str TC 17cm/6.75"
1ea.	11-161-17TC	MAYO Scss Cvd TC 17cm/6.75"
1ea.	11-280-23TC	METZENBAUM Scss Str TC 23cm/9"
1ea.	11-281-18TC	METZENBAUM Scss Cvd TC 18cm/7"
1ea.	11-281-23TC	METZENBAUM Scss Cvd TC 23cm/9"
1ea.	14-102-14	Dressing Forceps 14cm/5.5"
1ea.	14-120-14	Tissue Forceps 1x2 T 14.5cm /5.5"
1ea.	14-176-12	ADSON Dressing Forceps 12cm/4.75"
1ea.	14-186-12	ADSON Tissue Forceps 1x2 T 12cm/4.75"
1ea.	14-220-17	CUSHING Dressing Forceps Str 17cm/6.75"
1ea.	14-256-20	RUSSIAN Tissue Forceps 20cm/8"
1ea.	14-310-17	CUSHING Tissue Forceps 1x2T 17cm/6.75"
1ea.	16-306-20	DE BAKEY Forceps Atraumatic Straight 1.5mm 20cm/8"
6ea.	18-220-12	HALSTED Mosq Fcps Str 12.5cm/4.75"
6ea.	18-221-12	HALSTED Mosq Fcps Cvd 12.5cm/4.75"
6ea.	18-240-14	KELLY Fcps Str 14cm/5.5"
12ea.	18-241-14	KELLY Fcps Cvd 14cm/5.5"
6ea.	18-311-16	ROCHESTER-PEAN Fcps Cvd 16cm/6.25"
2ea.	18-311-20	ROCHESTER-PEAN Fcps Cvd 20cm/8"
4ea.	18-320-16	ROCHESTER-OCHSNER Fcps 1x2 T Str 16cm/6.25"
1ea.	18-471-18	MIXTER Forceps 18cm/7"
1ea.	18-471-23	MIXTER Forceps 23cm/9"
1ea.	18-475-14	BABY-MIXTER Fcps 14cm/5.5"
2ea.	18-491-19	LAHEY Gall Duct Forceps 19cm/7.5"
8ea.	20-111-13	BACKHAUS Towel Forceps 13cm/5.25"
1ea.	22-170-25	FOERSTER Sponge Fcps Serr Str 25cm/9.5"
1ea.	24-131-21	US-ARMY Retractor Double 21cm/8.25"
2ea.	24-135-19	GOELET Retractor Double 37x40mm 19cm/7.5"
1ea.	24-152-25	RICHARDSON GRIP Retractor 20 X 25mm/10"
1ea.	24-152-38	RICHARDSON GRIP Retractor 38 X 38mm/10"
1ea.	24-158-64	RICHARDSON GRIP Retractor 41 X 64mm/10"
1ea.	24-170-20	RIBBON Retractor 20 X 330mm .75"x 13"
1ea.	24-170-32	RIBBON Retractor 32 X 330mm 1.25" x 13"
1ea.	24-170-50	RIBBON Retractor 50 X 330mm 2"x 13"
1ea.	24-183-25	DEAVER Retractor 25 X 300mm 1"x 12"
1ea.	24-187-50	DEAVER Retractor 50 X 300mm 2"x 12"
1ea.	24-767-18	BALFOUR Abdominal Retractor 18cm/7"



## Suggested Surgical Sets Modelos para cirugía (Cont.)

### Basic Laparotomy Set (Cont.)

Quantity	BOOTNAS Catalog #	Description
1ea.	30-180-16TC	MAYO-HEGAR Needle Holder TC 15cm/6"
1ea.	30-180-18TC	MAYO-HEGAR Needle Holder TC 18cm/7"
1ea.	30-180-20TC	MAYO-HEGAR Needle Holder TC 20cm/8"
1ea.	30-250-27TC	MASSON Needle Holder TC 27cm/10.5"
4ea.	56-187-19	SCHNIDT Tonsil Forceps Curved Closed Rings 19cm/7.5"
2ea.	72-110-15	ALLIS Tissue Forceps 4x5 Teeth 15cm/6"
2ea.	72-120-24	ALLIS Tissue Forceps 5x6 Teeth 24cm/9.5"
2ea.	72-160-16	BABCOCK Intestinal Forceps 16cm/6.25"
2ea.	72-160-24	BABCOCK Intestinal Forceps 24cm/9.5"

### Minor Basic Instrument Set

Quantity	BOOTNAS Catalog #	Description
1ea.	07-150-27	YANKAUER Aspiration Tube Complete 27cm/10.5"
1ea.	09-103-01	Scalpel Handle No. 3
1ea.	11-110-14	Operating Scss Sharp/Blunt Str 14.5cm/5.5"
1ea.	11-160-14TC	MAYO Scss Str TC 14.5cm/5.5"
1ea.	11-161-14TC	MAYO Scss Cvd TC 14.5cm/5.5"
1ea.	11-281-18TC	METZENBAUM Scss Cvd TC 18cm/7"
1ea.	14-102-14	Dressing Forceps 14cm/5.5"
4ea.	18-220-12	HALSTED Mosq Fcps Str 12.5cm/4.75"
4ea.	18-221-12	HALSTED Mosq Fcps Cvd 12.5cm/4.75"
4ea.	18-241-14	KELLY Fcps Cvd 14cm/5.5"
6ea.	20-111-13	BACKHAUS Towel Forceps 13cm/5.25"
1ea.	22-170-25	FOERSTER Sponge Fcps Serr Str 25cm/9.5"
2ea.	24-160-17	SENN-MILLER Retractor Sharp 17cm/6.75"
2ea.	24-281-03	VOLKMAN Retractor Blunt 3 Tooth 21.5cm/8.5"
1ea.	26-102-14	Probe Buttoned With Eye 14.5cm/5.5"
1ea.	26-112-14	Grooved Director Buttoned 14.5cm/5.5"
1ea.	30-160-15TC	CRILE-WOOD Needle Holder TC 15cm/6"
1ea.	30-180-16TC	MAYO-HEGAR Needle Holder TC 15cm/6"
1ea.	30-180-18TC	MAYO-HEGAR Needle Holder TC 18cm/7"
1ea.	44-295-09	FRAZIER Suction Tube 19cm 30° 9Fr
2ea.	56-187-19	SCHNIDT Tonsil Forceps Curved Closed Rings 19cm/7.5"
2ea.	72-110-15	ALLIS Tissue Forceps 4x5 Teeth 15cm/6"

### Plastic Set

Quantity	BOOTNAS Catalog #	Description
1ea.	11-281-14	METZENBAUM Scss Cvd 14cm/5.5"
1ea.	11-310-12	KILNER (Ragnell) Sciss Flat Cvd 12cm/4.75"
1ea.	11-340-11	IRIS Sciss Str 11cm/4.5"
1ea.	11-341-11	IRIS Sciss Cvd 11cm/4.5"
1ea.	11-824-12	WAGNER Scss Str S/S 12cm/4.75"



**Suggested Surgical Sets  
Modelos para cirurgia (Cont.)**

**Plastic Set (Cont.)**

<b>Quantity</b>	<b>BOOTNAS Catalog #</b>	<b>Description</b>
1ea.	14-176-12	ADSON Dressing Forceps 12cm/4.75"
1ea.	14-186-12	ADSON Tissue Forceps 1x2 T 12cm/4.75"
1ea.	14-188-12	ADSON-BROWN Tissue Fcps 7x7 T 12cm/4.75"
2ea.	18-220-12	HALSTED Mosq Fcps Str 12.5cm/4.75"
2ea.	18-221-12	HALSTED Mosq Fcps Cvd 12.5cm/4.75"
1ea.	18-241-14	KELLY Fcps Cvd 14cm/5.5"
1ea.	18-263-16	CRILE-RANKIN Fcps Cvd 16cm/6.25"
2ea.	18-431-16	GEMINI Forceps Cvd 16cm/6"
8ea.	20-111-09	BACKHAUS Towel Forceps 9cm/3.5"
1ea.	22-170-25	FOERSTER Sponge Fcps Serr Str 25cm/9.5"
2ea.	24-160-17	SENN-MILLER Retractor Sharp 17cm/6.75"
2ea.	24-216-01	JOSEPH Hook 1 Prong 16cm/6.25"
2ea.	24-216-05	JOSEPH Hook 2 Prong 5mm 16cm/6.25"
1ea.	24-631-10	JANSEN Retractor Blunt 10cm/4"
1ea.	24-651-10	WEITLANER Retractor Blunt 11cm/4"
1ea.	30-128-13TC	WEBSTER Needle Holder TC 13cm/5"
1ea.	30-160-15TC	CRILE-WOOD Needle Holder TC 15cm/6"
1ea.	44-295-09	FRAZIER Suction Tube 30° 9Fr 19cm/7.5"
2ea.	72-110-15	ALLIS Tissue Forceps 4x5 Teeth 15cm/6"

**Hand Set**

<b>Quantity</b>	<b>BOOTNAS Catalog #</b>	<b>Description</b>
2ea.	09-103-01	Scalpel Handle No. 3
1ea.	11-160-17TC	MAYO Scss Str TC 17cm/6.75"
1ea.	11-281-18TC	METZENBAUM Scss Cvd TC 18cm/7"
1ea.	11-283-18	METZENBAUM-FINO Scss Cvd 18cm/7"
1ea.	11-340-11TC	IRIS Sciss Str TC 11cm/4.5"
2ea.	14-102-14	Dressing Forceps 14cm/5.5"
2ea.	14-120-14	Tissue Forceps 1x2 T 14.5cm /5.5"
2ea.	14-176-12	ADSON Dressing Forceps 12cm/4.75"
2ea.	14-186-12	ADSON Tissue Forceps 1x2 T 12cm/4.75"
6ea.	18-220-12	HALSTED Mosq Fcps Str 12.5cm/4.75"
6ea.	18-221-12	HALSTED Mosq Fcps Cvd 12.5cm/4.75"
6ea.	18-241-14	KELLY Fcps Cvd 14cm/5.5"
4ea.	20-111-09	BACKHAUS Towel Forceps 9cm/3.5"
2ea.	22-170-18	FOERSTER Sponge Fcps Serr Str 18cm/7"
2ea.	24-220-01	Rigid Neck Retractor Sharp 1 Prong 16cm/6.25"
2ea.	24-235-21	CUSHING Vein Retractor 21.5cm/8.5"
2ea.	24-281-02	VOLKMAN Retractor Blunt 2 Prong 21.5cm/8.5"
2ea.	30-180-13TC	MAYO-HEGAR Needle Holder TC 13cm/5"
2ea.	72-120-15	ALLIS Tissue Forceps 5x6 Teeth 15cm/6"

## Suggested Surgical Sets Modelos para cirugía (Cont.)

### OBSTETRICAL AND GYNECOLOGICAL SURGERY

#### Basic Vaginal Instrument Set

Quantity	BOOTNAS Catalog #	Description
1ea.	09-103-01	Scalpel Handle No. 3
1ea.	09-105-02	Scalpel Handle No. 4 L
1ea.	11-110-14	Operating Scss Sharp/Blunt Str 14.5cm/5.5"
1ea.	11-160-17TC	MAYO Scss Str TC 17cm/6.75"
1ea.	11-161-17TC	MAYO Scss Cvd TC 17cm/6.75"
1ea.	11-281-18TC	METZENBAUM Scss Cvd TC 18cm/7"
1ea.	14-102-14	Dressing Forceps 14cm/5.5"
1ea.	14-102-20	Dressing Forceps 20cm/8"
1ea.	14-120-14	Tissue Forceps 1x2 T 14.5cm /5.5"
1ea.	14-120-20	Tissue Forceps 1x2 T 20cm/8"
4ea.	18-240-14	KELLY Fcps Str 14cm/5.5"
4ea.	18-241-14	KELLY Fcps Cvd 14cm/5.5"
4ea.	18-311-16	ROCHESTER-PEAN Fcps Cvd 16cm/6.25"
2ea.	18-320-16	ROCHESTER-OCHSNER Fcps 1x2 T Str 16cm/6.25"
8ea.	20-111-13	BACKHAUS Towel Forceps 13cm/5.25"
1ea.	22-170-25	FOERSTER Sponge Fcps Serr Str 25cm/9.5"
1ea.	22-231-26	BOZEMAN Sponge Fcps S-Shape Cvd 26cm/10.5"
1ea.	24-110-18	PARKER Retractor Double 18cm/7"
1ea.	24-181-25	DEAVER Retractor 25 X 230mm 1"x 9"
2ea.	72-120-19	ALLIS Tissue Forceps 5x6 Teeth 19cm/7.5"
1ea.	78-291-02	SIMS Specula Double End 70 x 30+35mm Fig.2
1ea.	78-309-00	AUVARD Vaginal Specula Fixed Weight 3 lbs. 105 x 38mm
2ea.	78-504-25	BRAUN Tenaculum Forceps Str. 25cm/10"
1ea.	78-505-24	SKENE Tenaculum Forceps 24cm/9.75"

#### DILATATION AND CURETTAGE SET

Quantity	BOOTNAS Catalog #	Description
1ea.	09-103-01	Scalpel Handle No. 3
1ea.	09-105-02	Scalpel Handle No. 4 L
1ea.	14-102-20	Dressing Forceps 20cm/8"
1ea.	14-242-14	LANE Forceps 2x3 Teeth 14.5cm/5.5"
4ea.	20-111-13	BACKHAUS Towel Forceps 13cm/5.25"
1ea.	22-170-25	FOERSTER Sponge Fcps Serr Str 25cm/9.5"
1ea.	22-231-26	BOZEMAN Sponge Fcps S-Shape Cvd 26cm/10.5"
1ea.	30-241-21TC	HEANEY Needle Holder Cvd TC 21cm/8.25"
1ea.	78-110-02	GRAVES Vaginal Speculum Medium
1ea.	78-271-01	JACKSON Vaginal Specula 75x38mm Fig.1
1ea.	78-271-02	JACKSON Vaginal Specula 90x38mm Fig.2
1ea.	78-271-03	JACKSON Vaginal Specula 100x38mm Fig.3
1ea.	78-309-00	AUVARD Vaginal Specula Fixed Weight 3 lbs. 105 x 38mm
1ea.	78-425-08	HEGAR Uterine Dilators D/E Set Of 8 In Khaki Roll
1ea.	78-504-25	BRAUN Tenaculum Forceps Str 25cm/10"



**Suggested Surgical Sets  
Modelos para cirugía (Cont.)**

**DILATATION AND CURETTAGE SET (Cont.)**

Quantity	BOOTNAS Catalog #	Description
1ea.	78-532-21	JACOBS Tenaculum Forceps Str 21cm/8.5"
1ea.	78-581-32	SIMS Uterine Sound Malleable 32cm/13.25"
1ea.	78-596-40	KEVORKIAN Biopsy Curette With Basket 4mm 30cm/12"
1ea.	78-710-07	SIMS Uterine Curette Sharp/Rigid Fig.1 7.5mm 28cm/11"
1ea.	78-710-09	SIMS Uterine Curette Sharp/Rigid Fig.3 10mm 28cm/11"
1ea.	78-710-12	SIMS Uterine Curette Sharp/Rigid Fig.5 13.5mm 28cm/11"

**OPHTHALMIC SURGERY**

**Basic Eye Set**

Quantity	BOOTNAS Catalog #	Description
1ea.	09-103-01	Scalpel Handle No. 3
1ea.	09-107-00	Scalpel Handle No. 7
1ea.	09-109-10	Mini Scalpel Blade Handle 10cm/4.25"
1ea.	11-340-09	IRIS Sciss Str 9cm/4"
1ea.	11-341-09	IRIS Sciss Cvd 9cm/4"
1ea.	11-361-11	STEVENS Scissors Sharp/Sharp Curved 11cm/4.5"
1ea.	11-365-09	GRADLE Eye Suture Scissors 9.5cm/3.75"
1ea.	12-140-08	VANNAS Ophthalmic Sciss Straight 8cm/3 1/8"
1ea.	12-151-11	CASTROVIEJO Corneal Scissors Left 11cm/4.5"
1ea.	12-153-11	CASTROVIEJO Corneal Scissors Right 11cm/4.5"
1ea.	12-320-09	Micro Scissors Straight 9cm/3.5"
4ea.	18-222-12	HALSTED Mosq Fcps Micro Str 12cm/4.75"
6ea.	18-223-12	HALSTED Mosq Fcps Micro Cvd 12cm/4.75"
4ea.	20-111-09	BACKHAUS Towel Forceps 9cm/3.5"
1ea.	24-230-14	DESMARRES Retractor (Eyelid) 14mm 16cm/6.25"
1ea.	30-676-14TC	CASTROVIEJO Needle Holder Str Serr With Catch TC 14.5cm/5.5"
1ea.	46-129-07	LANCASTER Eye Speculum 7cm/2.75"
1ea.	46-132-08	CASTROVIEJO Eye Speculum 8cm/3 1/8"
1ea.	46-351-02	GRAEFE Strabismus Hook 10mm Fig.2 14cm/5.5"
1ea.	46-521-12	CASTROVIEJO Cyclodialysis Spatula
1ea.	46-583-07	CASTROVIEJO Marker 0-20mm 7cm/2.75"
1ea.	46-810-10	EYE Dressing Fcps Str 10cm/4.25"
1ea.	46-811-10	EYE Dressing Fcps Cvd 10cm/4.25"
1ea.	46-820-10	IRIS Forceps 1x2 Teeth Str 10cm/4"
1ea.	46-821-10	IRIS Forceps 1x2 Teeth Cvd 10cm/4"
1ea.	48-050-11	GRAEFE Fixation Forceps Without Lock 11cm/4.5"
1ea.	48-111-10	ARRUGA Capsular Forceps 10cm/4"
1ea.	48-150-03	CASTROVIEJO Suturing Forceps Straight 0.30mm
1ea.	48-256-09	DESMARRES Chalazion Forceps Medium 9cm/3.5"

## Suggested Surgical Sets Modelos para cirugía (Cont.)

### EAR, NOSE AND THROAT SURGERY

#### Basic Ear Set

Quantity	BOOTNAS Catalog #	Description
1ea.	09-103-01	Scalpel Handle No. 3
1ea.	11-161-14TC	MAYO Scss Cvd TC 14.5cm/4.5"
1ea.	11-283-15TC	METZENBAUM-FINO Scissors Curved TC 15cm/6"
1ea.	11-283-18TC	METZENBAUM-FINO Scissors Curved TC 18cm/7"
1ea.	11-371-11	STRABISMUS Scissors Curved 11cm/4.5"
1ea.	11-831-12	UNIVERSAL Wire Scissors 12cm/4 3/4"
1ea.	14-176-12	ADSON Dressing Forceps 12cm/4.75"
1ea.	14-186-12	ADSON Tissue Forceps 1x2 T 12cm/4.75"
6ea.	18-220-12	HALSTED Mosq Fcps Str 12.5cm/4.75"
2ea.	18-240-14	KELLY Fcps Str 14cm/5.5"
4ea.	20-111-09	BACKHAUS Towel Forceps 9cm/3.5"
2ea.	24-160-17	SENN-MILLER Retractor Sharp 17cm/6.75"
2ea.	24-216-01	JOSEPH Hook 1 Prong 16cm/6.25"
1ea.	24-310-01	LANGENBECK Retractor 30x11mm 22cm/9"
1ea.	24-310-04	LANGENBECK Retractor 40x11mm 22cm/9"
1ea.	24-620-10	ALM Retractor Sharp 10cm/4"
1ea.	24-631-10	JANSEN Retractor Blunt 10cm/4"
1ea.	24-675-13	WULLSTEIN Retractor 13cm/5"
1ea.	30-140-13TC	HALSEY Needle Holder Serrated TC 13cm/5"
1ea.	44-295-07	FRAZIER Suction Tube 30° 7Fr 19cm/7.5"
1ea.	44-295-09	FRAZIER Suction Tube 30° 9Fr 19cm/7.5"
1ea.	48-050-11	GRAEFE Fixation Forceps Without Lock 11cm
1ea.	50-020-30	FARRIOR Ear Specula 3 x 4 mm
1ea.	50-020-45	FARRIOR Ear Specula 4.5 x 5.5 mm
1ea.	50-020-55	FARRIOR Ear Specula 5.5 x 6.5 mm
1ea.	50-020-65	FARRIOR Ear Specula 6.5 x 7.5 mm
1ea.	50-111-00	BUCK Ear Curette Straight Sharp Fig. 00
1ea.	50-112-01	BUCK Ear Curette Straight Sharp Fig. 1
1ea.	52-154-20	JANSEN Nasal Forceps 20cm/8"
1ea.	52-415-18	FREER Septum Elevator Blunt 18cm/7"
2ea.	72-110-15	ALLIS Tissue Forceps 4x5 Teeth 15cm/6"

#### Basic Nasal Set

Quantity	BOOTNAS Catalog #	Description
1ea.	07-150-27	YANKAUER Aspiration Tube Complete 27cm/10.5"
1ea.	09-103-01	Scalpel Handle No. 3
1ea.	09-107-00	Scalpel Handle No. 7
1ea.	11-161-14TC	MAYO Scss Cvd TC 14.5cm/4.5"
1ea.	11-283-15TC	METZENBAUM-FINO Scissors Curved TC 15cm/6"
1ea.	11-283-18TC	METZENBAUM-FINO Scissors Curved TC 18cm/7"
1ea.	11-304-14	JOSEPH Sciss Fine Str 14.5cm/5.5"
1ea.	11-305-14	JOSEPH Sciss Fine Cvd 14.5cm/5.5"



**Suggested Surgical Sets  
Modelos para cirurgia (Cont.)**

**Basic Nasal Set (Cont.)**

<b>Quantity</b>	<b>BOOTNAS Catalog #</b>	<b>Description</b>
1ea.	11-825-12	WAGNER Scss Cvd S/S 12cm/4.75"
2ea.	14-186-12	ADSON Tissue Forceps 1x2 T 12cm/4.75"
6ea.	18-220-12	HALSTED Mosq Fcps Str 12.5cm/4.75"
4ea.	20-111-09	BACKHAUS Towel Forceps 9cm/3.5"
1ea.	24-131-21	US-ARMY Retractor Double 21cm/8.25"
2ea.	24-160-17	SENN-MILLER Retractor Sharp 17cm/6.75"
1ea.	24-216-01	JOSEPH Hook 1 Prong 16cm/6.25"
1ea.	24-216-02	JOSEPH Hook 2 Prong 2mm 16cm/6.25"
1ea.	24-216-07	JOSEPH Hook 2 Prong 7mm 16cm/6.25"
1ea.	26-270-16	FARRELL Cotton Applicators 16.5cm
1ea.	30-140-13TC	HALSEY Needle Holder Serr TC 13cm/5"
2ea.	44-295-07	FRAZIER Suction Tube 30° 7Fr 19cm/7.5"
1ea.	48-050-11	GRAEFE Fixation Forceps Without Lock 11cm/4.25"
1ea.	52-112-02	VIENNA Nasal Speculum Medium
1ea.	52-120-75	KILLIAN Nasal Speculum 75mm 13cm/5"
1ea.	52-124-50	COTTLE Nasal Speculum 50mm 14cm/5 1/2"
1ea.	52-151-18	WILLDE-TROELTSCH Nasal Forceps 18cm/7"
1ea.	52-551-16	AUFRICHT Nasal Retractor 16cm/6.25"
2ea.	72-102-14	BABY-ALLIS Tissue Forceps 4x5 Teeth 14cm/5 1/2"

**ORTHOPEDIC SURGERY**

**Basic Major Orthopedic Set**

<b>Quantity</b>	<b>BOOTNAS Catalog #</b>	<b>Description</b>
2ea.	24-280-01	VOLKMAN Retractor Blunt 1 Prong 21.5cm/8.5"
1ea.	38-370-27	LAMBOTTE Bone Holding Forceps 27cm/11"
2ea.	38-378-21	KERN Bone Holding Forceps Without Ratchet 21cm/8.5"
1ea.	38-384-33	LANE Bone Holding Forceps With Ratchet 33cm/13.25"
1ea.	38-441-13	LOWMAN Bone Holding Clamp 13cm/5"
1ea.	38-441-20	LOWMAN Bone Holding Clamp 20cm/8"
1ea.	38-670-06	HIBBS Osteotome Straight 6mm 24cm/9.5"
1ea.	38-670-13	HIBBS Osteotome Straight 13mm 24cm/9.5"
1ea.	38-670-19	HIBBS Osteotome Straight 19mm 24cm/9.5"
1ea.	38-670-32	HIBBS Osteotome Straight 32mm 24cm/9.5"
1ea.	38-671-09	HIBBS Osteotome Curved 9mm 24cm/9.5"
1ea.	38-671-16	HIBBS Osteotome Curved 16mm 24cm/9.5"
1ea.	38-671-25	HIBBS Osteotome Curved 25mm 24cm/9.5"
1ea.	38-673-06	HIBBS Gouge Straight 6mm 24cm/9.5"
1ea.	38-673-13	HIBBS Gouge Straight 13mm 24cm/9.5"
1ea.	38-673-19	HIBBS Gouge Straight 19mm 24cm/9.5"
1ea.	38-675-09	HIBBS Gouge Curved 9mm 24cm/9.5"
1ea.	38-675-16	HIBBS Gouge Curved 16mm 24cm/9.5"
1ea.	38-688-45	KAMBO Mallet 450g 26.5cm/10.5"





## Suggested Surgical Sets Modelos para cirugía (Cont.)

### Basic Major Orthopedic Set

Quantity	BOOTNAS Catalog #	Description
1ea.	38-758-01	SAYRE Elevator Sharp 17cm/6.75"
1ea.	38-759-06	KEY Elevator 6mm 19cm/7.5"
1ea.	38-759-12	KEY Elevator 12mm 19cm/7.5"
1ea.	38-759-25	KEY Elevator 25mm 19cm/7.5"

### Basic Orthopedic Soft Tissue Set

Quantity	BOOTNAS Catalog #	Description
1ea.	05-340-15	Metal Ruler Mm/Inch 15cm/6"
1ea.	09-103-01	Scalpel Handle No. 3
1ea.	09-104-00	Scalpel Handle No. 4
1ea.	11-160-14TC	MAYO Scss Str TC 14.5cm/5.5"
1ea.	11-161-14TC	MAYO Scss Cvd TC 14.5cm/5.5"
1ea.	11-281-18TC	METZENBAUM Scss Cvd TC 18cm/7"
1ea.	11-901-14	LISTER Bandage Sciss 14cm/5.5"
1ea.	14-120-16	Tissue Forceps 1x2 T 16cm/6.25"
1ea.	14-160-16	Tissue Forceps 4x5 T 16cm/6.25"
1ea.	14-176-12	ADSON Dressing Forceps 12cm/4.75"
4ea.	18-220-12	HALSTED Mosq Fcps Str 12.5cm/4.75"
4ea.	18-221-12	HALSTED Mosq Fcps Cvd 12.5cm/4.75"
6ea.	18-241-14	KELLY Fcps Cvd 14cm/5.5"
4ea.	18-322-14	KOCHER Hemo Fcps Str 14cm/5.5"
6ea.	20-111-13	BACKHAUS Towel Forceps 13cm/5.25"
1ea.	24-131-21	US-ARMY Retractor Double 21cm/8.25"
1ea.	24-160-17	SENN-MILLER Retractor Sharp 17cm/6.75"
1ea.	24-161-17	SENN-MILLER Retractor Blunt 17cm/6.75"
2ea.	24-216-01	JOSEPH Hook 1 Prong 16cm/6.25"
2ea.	24-216-07	JOSEPH Hook 2 Prong 7mm 16cm/6.25"
1ea.	24-280-02	VOLKMAN Retractor Sharp 2 Prong 21.5cm/8.5"
1ea.	24-280-03	VOLKMAN Retractor Sharp 3 Prong 21.5cm/8.5"
1ea.	24-310-01	LANGENBECK Retractor 30x11mm 22cm/9"
1ea.	24-310-04	LANGENBECK Retractor 40x11mm 22cm/9"
1ea.	24-484-01	HIBBS Retractor 25x75mm 24cm/9.5"
1ea.	24-670-14	WEITLANER Retractor Sharp 14cm/5.5"
1ea.	24-671-14	WEITLANER Retractor Blunt 14cm/5.5"
1ea.	30-128-13TC	WEBSTER Needle Holder TC 13cm/5"
1ea.	30-160-15TC	CRILE-WOOD Needle Holder TC 15cm/6"
1ea.	38-211-15	RUSKIN Bone Rongeur Str 3mm Bite 15cm/6"
1ea.	38-286-18	RUSKIN-LISTON Bone Cutting Fcps Str 18cm/7"
1ea.	38-694-01	ANMUTH Hammer with Nylon Caps
1ea.	38-757-17	ADSON Raspatories Curved 17cm/6.75"
1ea.	38-758-01	SAYRE Elevator Sharp 17cm/6.75"
1ea.	38-759-06	KEY Elevator 6mm 19cm/7.5"
1ea.	38-759-12	KEY Elevator 12mm 19cm/7.5"
1ea.	44-295-09	FRAZIER Suction Tube 30° 9Fr 19cm/7.5"



**Suggested Surgical Sets  
Modelos para cirugía (Cont.)**

**Basic Orthopedic Soft Tissue Set (Cont.)**

Quantity	BOOTNAS Catalog #	Description
1ea.	52-415-18	FREER Septum Elevator Blunt 18cm/7"
4ea.	72-110-15	ALLIS Tissue Forceps 4x5 Teeth 15cm/6"

**Knee Set**

Quantity	BOOTNAS Catalog #	Description
1ea.	05-340-15	Metal Ruler Mm/Inch 15cm/6"
1ea.	09-103-01	Scalpel Handle No. 3
1ea.	09-107-00	Scalpel Handle No. 7
1ea.	11-160-17TC	MAYO Scss Str TC 17cm/6.75"
1ea.	11-161-17TC	MAYO Scss Cvd TC 17cm/6.75"
1ea.	11-281-14TC	METZENBAUM Scss Cvd TC 14cm/5.5"
1ea.	11-281-18TC	METZENBAUM Scss Cvd TC 18cm/7"
1ea.	11-901-14	LISTER Bandage Sciss 14cm/5.5"
1ea.	14-120-14	Tissue Forceps 1x2 T 14.5cm /5.5"
1ea.	14-176-12	ADSON Dressing Forceps 12cm/4.75"
2ea.	14-186-12	ADSON Tissue Forceps 1x2 T 12cm/4.75"
1ea.	14-232-15	LERCHE Forceps 5x6 Teeth 15cm/6"
6ea.	18-241-14	KELLY Fcps Cvd 14cm/5.5"
4ea.	18-320-16	ROCHESTER-OCHSNER Fcps 1x2 T Str 16cm/6.25"
6ea.	20-111-09	BACKHAUS Towel Forceps 9cm/3.5"
1ea.	24-131-21	US-ARMY Retractor Double 21cm/8.25"
1ea.	24-160-17	SENN-MILLER Retractor Sharp 17cm/6.75"
1ea.	24-161-17	SENN-MILLER Retractor Blunt 17cm/6.75"
1ea.	24-280-02	VOLKMAN Retractor Sharp 2 Prong 21.5cm/8.5"
1ea.	24-280-04	VOLKMAN Retractor Sharp 4 Prong 21.5cm/8.5"
1ea.	24-671-14	WEITLANER Retractor Blunt 14cm/5.5"
1ea.	30-128-13TC	WEBSTER Needle Holder TC 13cm/5"
1ea.	30-160-18TC	CRILE-WOOD Needle Holder TC 18cm/7"
1ea.	38-410-19	MARTIN Bone Holding Forceps 19cm/7.5"
1ea.	38-694-01	ANMUTH Hammer with Nylon Caps
1ea.	38-757-17	ADSON Raspatories Curved 17cm/6.75"
1ea.	38-758-01	SAYRE Elevator Sharp 17cm/6.75"
1ea.	38-759-12	KEY Elevator 12mm 19cm/7.5"
1ea.	38-759-25	KEY Elevator 25mm 19cm/7.5"
1ea.	38-801-08	HOHMAN Bone Lever 8mm
1ea.	38-801-43	HOHMAN Bone Lever 43mm
2ea.	38-827-17	BLOUNT Meniscotome 17.5cm/7.75"
1ea.	38-832-03	SMILLIE Bone Lever 32 X 19mm 14cm/5 1/2"
1ea.	38-910-17	SMILLIE Meniscotome 17cm/6.75"
1ea.	38-911-17	SMILLIE Meniscotome Left 17cm/6.75"
1ea.	38-913-17	SMILLIE Meniscotome Right 17cm/6.75"
1ea.	44-061-16	GRAHAM Nerve Hook 16.5cm/6.5"
1ea.	44-069-20	ADSON Dura Hook 20cm/8"

## Suggested Surgical Sets Modelos para cirugía (Cont.)

### Knee Set (Cont.)

Quantity	BOOTNAS Catalog #	Description
4ea.	72-110-15	ALLIS Tissue Forceps 4x5 Teeth 15cm/6"
1ea.	52-415-18	FREER Septum Elevator Blunt 18cm/7"

### SUTURE

#### Small Suture Set

Quantity	BOOTNAS Catalog #	Description
1ea.	09-103-01	Scalpel Handle No. 3
1ea.	11-370-11	STRABISMUS Scss Str 11cm/4.5"
1ea.	11-371-11	STRABISMUS Scss Cvd 11cm/4.5"
2ea.	14-186-12	ADSON Tissue Forceps1x2 T 12cm/4.75"
2ea.	18-211-10	HARTMAN Mosq Fcps Cvd 10cm/4.25"
4ea.	18-221-12	HALSTED Mosq Fcps Cvd 12cm/4.75"
2ea.	30-128-13TC	WEBSTER Needle Holder TC 13cm/5"

#### Emergency Room Suture Set

Quantity	BOOTNAS Catalog #	Description
1ea.	09-103-01	Scalpel Handle No. 3
1ea.	11-110-14	Operating Scss Sharp/Blunt Str 14.5cm/5.5"
1ea.	11-310-12	KILNER (Ragnell) Sciss Flat Cvd 12cm/4.75"
1ea.	14-176-12	ADSON Dressing Forceps 12cm/4.75"
1ea.	14-186-12	ADSON Tissue Forceps1x2 T 12cm/4.75"
2ea.	18-220-12	HALSTED Mosq Fcps Str 12.5cm/4.75"
2ea.	18-221-12	HALSTED Mosq Fcps Cvd 12cm/4.75"
1ea.	18-240-14	KELLY Fcps Str 14cm/5.5"
1ea.	18-241-14	KELLY Fcps Cvd 14cm/5.5"
2ea.	20-111-09	BACKHAUS Towel Forceps 9cm/3.5"
1ea.	30-160-15TC	CRILE-WOOD Needle Holder TC 15cm/6"

**Index**  
**Indice**  
**Indice**

ABRAHAM Tonsil Knife	466	A-BOOTNAS Nasal Specula	423
Adenoid Curette BARNHILL	450	A-BOOTNAS Plaster Retractor	232
Adenoid Curette BECKMANN	450	A-BOOTNAS Sickle Knives	435
Adenoid Curette St. CLAIR-THOMSON	450	A-BOOTNAS Skin Hook	150
Adenotome LAFORCE	450	A-BOOTNAS Sterilization Forceps	615
ADLERKREUTZ Vascular Tissue Forceps	84	A-BOOTNAS Tuning Fork	403
ADSON BABY Hemostatic Clamp	113	Anoscope HIRSCHMANN	563
ADSON BABY Retractors	173	Anoscope IVES-FANSLER	563
ADSON Bone Rongeur	236	Antrum Curette	435
ADSON Dressing Forceps	82	Antrum Curette COAKLEY	449
ADSON Dura Hook	328	Antrum Rasp GALLAHER	446
ADSON Hemostatic Clamp	112	Antrum Rasp LEWIS	443
ADSON Holding Clamp	298	Aortic Dilator COOLEY	528
ADSON Hypophyseal Tissue Forceps	334	Aortic Dilator TUBBS	528
ADSON Micro Tissue Forceps	82	Appendix Intestinal Forceps ALLEN	544
ADSON Needle Holder	211	Appendix Intestinal Forceps KLEINSCHMIDT	544
ADSON Raspatory	282	Applying Forceps Aneurysm Clip	357 to 360
ADSON Retractors	172 to 174	Applying Forceps BIEMER	361, 366
ADSON Suction Tube	336	Applying Forceps JOHNS-HOPKINS	104
ADSON Tissue Forceps	82	Applying Forceps McKENZIE	326
ADSON-BROWN (OWEN) Micro Tissue Forceps	96	Applying Forceps MEHDORN	362
ADSON-BROWN Tissue Forceps	83	Applying Forceps RANEY	327
AEBLI Ophthalmology Scissors	58	Applying Forceps SMITHWICK	326
Air Blower	405	Applying Forceps SWEET	326
Air Blower POLITZER	406	Approximator BIEMER	366
Air Pump	295	Approximator BIEMER-MUELLER	363
ALAN-PARKS Rectal Specula	561	Approximator MUELLER	364
ALDERDYCE Elevator	282	ARCHER Splinter Forceps	92
ALEXANDER Biopsy Forceps	589	ARLT Cataract Loop	378
ALEXANDER Chisels	259	Arm System Endoscopic	188, 189
ALEXANDER Raspatory	276	ARRUGA Capsular Forceps	391
ALLEN Appendix Intestinal Forceps	544	ARRUGA Extraction Hook	375
ALLIS Bowel Grasping Forceps	537	ARRUGA Eye Specula	370
ALLIS-ADAIR Bowel Grasping Forceps	537	ARRUGA Needle Holder	214
ALLIS-BABY Bowel Grasping Forceps	537	ARRUGA Wound Curette	378
ALLISON Lung Spatula	489	ASCH Septum Straightening Forceps	449
ALM Retractor	168	Aspirating and Specimen Curettes	600
ALVIS Foreign Body Curette	374	Atraumatic Bulldog Clamp GLOVER	103
Amnioscope	601	Atraumatic Neonatal Clamp	523
Amniotome BEACHAM	586	Atraumatic Vascular Clamps Delicate	526
Amputation Knives ANMUTH	44	Atraumatic Bulldog Clamp	100, 102
Amputation Knives CATLIN	44	Atraumatic Tissue Forceps DEBAKEY	99
Amputation Knives LANGENBECK	44	AUFRANC Retractor	289
Amputation Knives LISTON	44	AUFRICHT Nasal Rasp	443
Amputation Saw BIER	296	AUFRICHT Retractor	447
Amputation Saw CHARRIERE	296	Auricle Clamp HARKEN	503
Amputation Saw SATTERLEE	296	AUVARD Vaginal Specula	576
Anal Retractor SMITH-BUIE	561	Awl OBWEGESER	463
Anastomosis Clamp DE MARTEL-WOLFSON	546	Awl PERTHES	304
Anastomosis Clamp BECK	520	Awl T-BAR	304
Anastomosis Clamp COOLEY	519, 520	Awls	304
Anastomosis Clamp COOLEY-DERRA	519	AXENFELD Chalazion Curette	377
Anastomosis Clamp DEBAKEY	505	AYER Chalazion Tissue Forceps	393
Anastomosis Clamp LAMBERT-KAY	505		
ANDERSON Breast Retractor	198	B	
ANDERSON-ADSON Retractors	172	BABCOCK Bowel Grasping Forceps	539
ANDREW Tongue Depressor	452	BABINSKI Percussion Hammer	24
ANDREWS-PYNCHON Suction Tube	28	BABY-ADSON Hemostatic Clamp	113
Aneurysm Clip Applier Forceps	357 to 360	BABY-ADSON Retractor	173
Aneurysm Clamp DEBAKEY -BAHNSON	506	BABY-ALLIS Tissue Forceps	537
Aneurysm Vascular Clip YASARGIL	349 to 356	BABY-BAILEY Rib Spreader	489
A-BOOTNAS Amputation Knives	44	BABY-BALFOUR Abdominal Retractors	182
A-BOOTNAS Bladebreaker	45	BABY-BURKE Biopsy Forceps	590
A-BOOTNAS Bone Curettes	256	BABY-DOYEN Intestinal Forceps	540
A-BOOTNAS Bone Hand Drills	300	BABY-FINNOCHIETTO Rib Spreader	482
A-BOOTNAS Bone Holding Forceps	246, 247	BABY-GOSSET Abdominal Retractors	181
A-BOOTNAS Bowel Grasping Forceps	111	BABY-KOCHER Intestinal Forceps	540
A-BOOTNAS Cilia Forceps	395	BABY-METZENBAUM Supercut Scissors	71
A-BOOTNAS Cotton Applicator	203	BABY-MIKULICZ Peritoneum Clamp	123
A-BOOTNAS Eye Magnet	395	BABY-MIXTER Hemostatic Clamp	119
A-BOOTNAS Finger Ring Saw	297	BABY-OLSEN HEGAR Needle Holder	212
A-BOOTNAS Hammer	270	BABY-OVERHOLT Hemostatic Clamp	114

**Index  
Indice  
Indice**

BABYPHON Sphygmomanometer	10	BERGH Cilia Forceps	395
BABY-TISCHLER Biopsy Forceps	592	BERGMANN Bandage Scissors	69
BABY-TROUSSEAU Trachea Dilator	476	BERGMANN Hammer	272
BABY-WEBSTER Needle Holder	208	BERKE Muscle Forceps	389
BABY-YANKAUER Suction Tube	27	BERLINER Percussion Hammer	24
Back Holder Abdominal Retractor Set	192, 193	BERNHARD Towel Clamp	133
Back Holder Abdominal Retractor Set Parts	193 to 195	BERRY Wire Forceps	319
BACKHAUS Towel Clamp	132	BETHUNE Rib Shears	481
BACKHAUS-CLIP Forceps	132	BEYER Bone Rongeur	237, 238
BAILEY Rib Spreader	489	BIEMER Approximator	366
BAILEY-GIBBON Rib Spreader	489	BIEMER Clip Appying Forceps	361
BAINBRIDGE Hemostatic Clamp	120	BIEMER Vascular Clips	361
BAINBRIDGE Vascular Clamp	495	BIEMER-MUELLER Approximator	363
BAKES Gall Duct Dilator	532	BIER Amputation Saw	296
BALFOUR Abdominal Retractors	182	BILLEAU Ear Loops	409
BALFOUR-US Abdominal Retractor Blades	183, 184	Biopsy Curette HEANEY	587
BALL and SOCKET Towel Clamp	133	Biopsy Curette KEVORKIAN	587
Ball Electrode Monopolar	628, 629	Biopsy Curette NOVAK	587
BALLENGER Septum Elevator	439	Biopsy Curette RANDALL	587
BALLENGER Swivel Knives	436	Biopsy Curette Type MUENCHEN	587
BALLENGER Tonsil Forceps	467	Biopsy Forceps ALEXANDER	589
Bandage Scissors BERGMANN	69	Biopsy Forceps BABY-BURKE	590
Bandage Scissors BRUNS	70	Biopsy Forceps BURKE	590
Bandage Scissors ESMARCH	69	Biopsy Forceps EPPENDORFER	590
Bandage Scissors FIRST AID	70	Biopsy Forceps FAURE	588
Bandage Scissors KNOWLES	70	Biopsy Forceps KEVORKIAN	589
Bandage Scissors LISTER	69	Biopsy Forceps KEVORKIAN-PACIFIC	592
Bandage Scissors LORENZ	70	Biopsy Forceps MAXI GRASPER	593
Bandage Scissors SEUTIN	69	Biopsy Forceps Rotating BURKE	591
Bandage Scissors SMITH US ARMY	69	Biopsy Forceps Rotating KEVORKIAN	591
Bandage Scissors UNIVERSAL	70	Biopsy Forceps Rotating TISCHLER-DOWN	591
BANE-HARTMAN Bone Rongeur	237	Biopsy Forceps Rotating TISCHLER-MORGAN	591
BANGERTER Cyclodialysis Spatula	379	Biopsy Forceps Rotating TISCHLER-UP	591
BARACANI Interchangeable Tips	472	Biopsy Forceps Rotating TOWNSEND MINI	591
BARANY Air Blower	405	Biopsy Forceps SCHUBERT	588
BARBARA Hook	419	Biopsy Forceps SCHUMACHER	588, 589
BARBARA Needle	419	Biopsy Forceps THOMAS-GAYLOR	588
BARKAN Goniotomy Knife	373	Biopsy Forceps TISCHLER-KEVORKIAN	592
BARNHILL Adenoid Curette	450	Biopsy Forceps TISCHLER-MORGAN	590
BARON Suction Tube	336	Biopsy Forceps WITTNER	589
BARR Rectal Specula	559	Biopsy Needle FRANKLIN-SILVERMANN	206
BARRAQUER Cilia Forceps	395	Biopsy Needle MENGHINI	206
BARRAQUER Eye Scissors	75	Biopsy Punch Keyes	608
BARRAQUER Eye Specula	370	Bipolar Cable	633
BARRAQUER Fixation Forceps	390	Bipolar Tissue Forceps	630, 631
BARRAQUER Keratoplasty Knives	373	Bipolar Tissue Forceps Bayonet	632
BARRAQUER Needle Holder	216, 217	BIRCHER-GANSKE Bone Holding Forceps	246
BARRAQUER-KATZIN Iris Tissue Forceps	384	BIRKETT Hemostatic Clamp	116
BARRET Tenaculum	582	BISHOP-HARMON Iris Tissue Forceps	386
BARTON Obstetrical Forceps	603	Bladder Retractors JUDD-MASSON	552
Battery Handle for Cold Light	33	Bladder Retractors LEGUEU	553
Battery Handle for Warm Light	32	Bladder Retractors MILLIN	552
BAUMGARTNER Needle Holder	208	Bladder Retractors THOMSON-WALKER	552
BEACHAM Amniotome	586	Bladder Spatula KOCHER	552
BECK Anastomosis Clamp	520	Bladder Spatula LEGUEU	552
BECK Vascular Clamp	516	Bladder Spreader MILLIN	553
BECKER Cystotome	375	Blade for Dermatome	49
BECKMANN Adenoid Curette	450	Bladebreaker ANMUTH	45
BECKMANN Retractors	176	Bladebreaker CASTROVIEJO	45
BECKMANN-ADSON Retractors	175	Bladebreaker TROUTMAN-CHRIS	45
BECKMANN-EATON Retractors	176	Blade-Remover	42
BEEBEE Crown Scissors	68	Blades Scalpel	42
BEER Cilia Forceps	395	BLAKE Gall Stone Forceps	531
BEESON Plaster Spreader	232	BLAKE Uterine Curette	595
Bell Type Circumcision Clamp	556	BLOHMKE Tonsil Forceps	467
BELLUCI Micro Ear Forceps, Scissors	413, 417	Blood Vessel Clamp DIETRICH	510
Bender for Nails	322	Blood Vessel Clamp MORRIS-DEBAKEY	506
Bender LANE	325	Blood Vessel Clamp WEBER	501
BENGOLEA Hemostatic Clamp	112	BLOUNT Bone Levers	288, 289
BENNETT Bone Levers	283	Blower KABIERSKE	405
BENSON Pylorus Spreader	544	BLUMENTHAL Bone Rongeur	236
BERENS Dissection Knives	372	BODENHAMMER Rectal Specula	559

**Index**  
**Indice**  
**Indice**

BOEHLER Extension Bow	312	Bone Rongeur ECHLIN	240
BOERMA Obstetrical Forceps	604	Bone Rongeur FRIEDMAN Micro	234
BOETTCHEr Tonsil Scissors	59	Bone Rongeur FRIEDMAN Mini	234
BOIES Elevator	277	Bone Rongeur FRYKHOLM	240
BONACCOLTO Strabismus Forceps	385	Bone Rongeur JANSEN	237
Bone Curettes BRUNS	251, 254	Bone Rongeur KLEINERT-KUTZ	237
Bone Curettes BUSHE	256	Bone Rongeur LEKSELL-STILLE	240
Bone Curettes DAUBENSPECK	255	Bone Rongeur LEMPert	237
Bone Curettes HALLE	253	Bone Rongeur LUER	236
Bone Curettes JACOBSON	257	Bone Rongeur MARQUARDT	239
Bone Curettes JANSEN	257	Bone Rongeur MAYFIELD	238
Bone Curettes LEMPert	256	Bone Rongeur MEAD	235
Bone Curettes MARTINI	257	Bone Rongeur OLIVECRONA	237
Bone Curettes SCHEDE	251	Bone Rongeur RUSKIN	238, 239
Bone Curettes SCOVILLE	253	Bone Rongeur SAUERBRUCH	240
Bone Curettes SPINAL	253	Bone Rongeur SCAGLIETTI	240
Bone Curettes SPRATT	251	Bone Rongeur SEMB	240
Bone Curettes VOLKMANN	251, 257	Bone Rongeur SMITH-PETERSEN	238
Bone Curettes WILLIGER	255, 257	Bone Rongeur STELLBRINK	234
Bone Cutting Forceps COTTLE-KAZANJIAN	241	Bone Rongeur STILLE-LUER	239
Bone Cutting Forceps LISTON	241	Bone Rongeur STILLE-RUSKIN	239
Bone Cutting Forceps McINDOE	241	Bone Rongeur ZAUFAL-JANSEN	238
Bone Cutting Forceps RUSKIN	241	Bone Wire Soft	314
Bone Cutting Forceps SEMB	242	BONN Iris Tissue Forceps	387
Bone Cutting Forceps STILLE-LISTON	241, 242	BONN Irrigation Cannula	394
Bone Drill Bits	302	BONNEY Tissue Forceps	88
Bone Files and Rasps	294	BOSE Trachea Hook	476, 477
Bone Hand Drill BUNELL	299	BOSE Tracheal Retractor	476
Bone Hand Drill HUDSON	299	BOUCHERON Ear Specula	399
Bone Hand Drill KIRSCHNER	299	Bowel Grasping Forceps ALLIS	537
Bone Hand Drill MOORE	298	Bowel Grasping Forceps ALLIS-ADAIR	537
Bone Hand Drill RALK	300	Bowel Grasping Forceps ALLIS-BABY	537
Bone Hand Drill STILLE	298	Bowel Grasping Forceps Atraumatic	111
Bone Hand Drill STILLE-SHERMAN	298	Bowel Grasping Forceps BABCOCK	539
Bone Holding Clamp FELDHEIM	249	Bowel Grasping Forceps COLLIN	539
Bone Holding Clamp GERSTER	250	Bowel Grasping Forceps DOYEN-BABY	540
Bone Holding Clamp LAMBERT-LOWMAN	249	Bowel Grasping Forceps DUVAL	539
Bone Holding Clamp LOWMAN	249	Bowel Grasping Forceps JUDD-ALLIS	538
Bone Holding Clamp LOWMAN-HOGLUND	249	Bowel Grasping Forceps LITTLEWOOD	538
Bone Holding Forceps	249	Bowel Grasping Forceps LOCKWOOD-ALLIS	538
Bone Holding Forceps ANMUTH	246	Bowel Grasping Forceps THOMS-ALLIS	538
Bone Holding Forceps BIRCHER-GANSKE	246	Bowel Grasping Forceps WILLIAMS	539
Bone Holding Forceps DINGMAN	246	Bowel Scissors	66
Bone Holding Forceps FARABEUf	243	Bowel Spatula HABERER	143
Bone Holding Forceps FARABEUf-LAMB	243	Bowel Spatula LERICHE	144
Bone Holding Forceps FERGUSSON	243	Bowel Spatula REVERDIN	143
Bone Holding Forceps KERN	244	Bowel Spatula Ribbon	143
Bone Holding Forceps LAMBOTTE	244	BOWMAN Dissection Knives	372
Bone Holding Forceps LANE	244	BOWMAN Dissection Needle	374
Bone Holding Forceps LANGENBECK	243	BOWMAN Eye Specula	370
Bone Holding Forceps LEWIN	246	BOWMAN Lacrimal Probes	381
Bone Holding Forceps REILL	248	BOYNTON Needle Holder	214
Bone Holding Forceps SEMB	243	BOZEMAN Sponge Dressing Forceps	138
Bone Holding Forceps ULRICH	248	BOZEMAN-DOUGLAS Sponge Dressing Forceps	138
Bone Holding Forceps VAN BUREN	249	BOZEMANN Needle Holder	211
Bone Holding Forceps VERBRUGGE	245	Brain Knives	48
Bone Hook VOLKMANN	156	Brain Spatula CUSHING	336
Bone Levers BENNETT	283	Brain Spatula CUSHING	369
Bone Levers BLOUNT	288	Brain Spatula HEIFETZ Malleable	369
Bone Levers HOHMANN	284, 285	Brain Spatula OLIVECRONA	336
Bone Levers HOHMANN Mini	286	BRAND Tendon Seizing Instrument	293
Bone Levers KOENIG	284	BRAND Tendon Stripper	294
Bone Levers LANGE-HOHMANN	286	BRAUN Cranioplast	607
Bone Levers SMILLIE	291	BRAUN Decapitating Hook	607
Bone Levers VERBRUGGE-MULLER	287	BRAUN Tenaculum	582
Bone Plate Holding Forceps LANE	325	BRAUN Uterine Depressor	586
Bone Rasp PUTTI	294	BRAUN-STADLER Episiotomy Scissors	64
Bone Rongeur ADSON	236	Breast Retractor	198
Bone Rongeur BANE-HARTMAN	237	BREISKY Vaginal Specula	577
Bone Rongeur BEYER	237, 238	BRISTOW Bone Levers	290
Bone Rongeur BLUMENTHAL	236	BRODIE Probes	199
Bone Rongeur CLEVELAND	235	Bronchus Clamp	126

**Index  
Indice  
Indice**

Bronchus Clamp FINOCCHIETTO	490	CASTROVIEJO Dissection Knives	372
Bronchus Clamp HARRINGTON	490	CASTROVIEJO Eye Specula	371
Bronchus Clamp LEES	504	CASTROVIEJO Fixation Forceps	390
Bronchus Clamp PRICE-THOMAS	490	CASTROVIEJO Lacrimal Dilator	381
Bronchus Clamp SEMB	491	CASTROVIEJO Micro Needle Holder	215
BROPHY Tissue Forceps	84	CASTROVIEJO Micro Scissors	79
BROWN Needle Holder	209	CASTROVIEJO Needle Holder	215
BROWN Tissue Forceps	83	CASTROVIEJO Suture Forceps	392
BRUENINGS Ear Specula	401	CASTROVIEJO-STANDARD Needle Holder	216
BRUENINGS Laryngeal Tips	472	Cataract Curette DAVIEL	377
BRUENINGS Septum Forceps	425	Cataract Curette GRAEFE	377
BRUENINGS Tongue Depressors	451	Cataract Knives DEUTSCHMANN	371
BRUENINGS Tonsil Knives	466	Cataract Knives GRAEFE	371
BRUENINGS Tonsil Snare	468	Cataract Loop ARLT	378
BRUNETTI Chisels	268	Cataract Loop SNELLEN	378
BRUNINGS-LUCAS Chisels	260	Cataract Loop WEBER	378
BRUNNER Guide Probes	221	Cataract Loop WILDER	378
BRUNNER Intestinal Forceps	543	Cataract Spoon KNAPP	378
BRUNNER Retractor	167	Catheter Forceps COOLEY	510
BRUNNER Rib Scissors	481	Catheter Guide GUYON	554
BRUNS Bone Curettes	251, 254	Catheter Introducing Forceps MAGILL	28
BRUNS Cast Shears	70	CATLIN Amputation Knives	44
Brush Dispenser	611	Cautery WADSWORTH-TODD	378
BRYANT Dressing Forceps	137	Cervical Traction Tong CRUTCHFIELD	327
BUCHWALD Tongue Depressors	451	Chalazion Curette AXENFELD	377
BUCK Ear Curettes	407	Chalazion Curette HEBRA	377
BUCK Foreign Body Lever	412	Chalazion Curette MEYHOEFER	377
BUCK Percussion Hammer	24	Chalazion Tissue Forceps AYER	393
BUCK-GRAMCKO Bone Levers	285	Chalazion Tissue Forceps DESMARRES	393
BUIE Rectal Suction Tube	566	Chalazion Tissue Forceps LAMBERT	393
Bulldog Clamp DEBAKEY	100, 103	CHANDLER Elevator	282
Bulldog Clamp DIETRICH	101	CHAPUT Tissue Grasping Forceps	110
Bulldog Clamp GLOVER	103	CHARNLEY Abdominal Retractors	289
Bulldog Clamp JOHNS-HOPKINS	104	CHARRIERE Amputation Saw	296
BUMM Uterine Curette	597	CHEATLE Sterilization Forceps	227
BUNELL Bone Hand Drills	299	Cheek Retractor STERNBERG	453
BUNELL Tendon Guide	294	CHELSEA-EATON Proctoscope	564
BUNELL Tendon Passing Instrument	292	CHERON Dressing Forceps	137
BUNGE Evisceration Scoop	378	CHERRY Laminectomy Retractor	488
BUNT Instrument Holder	227	Chest Support KLEINSASSER	36
BURCH Fixation Forceps	373	CHEVALIER-JACKSON Bronch Forceps	473
BURFORD-FINOCCHIETTO Rib Spreader	483	CHEVALIER-JACKSON Trachea Cannula	479
BURKE Biopsy Forceps	590	CHILDE Clip Forceps	224
BUSCH Scissors	64	Chisel Blade	266
BUSHE Bone Curette	256	Chisel BRUNETTI	268
Button Probes JACOBSON	335	Chisel HIBBS	265
		Chisel HOKE	265
C		Chisel KILLIAN	442
Cable Bipolar	633	Chisel LAMBOTTE	261
Calipers	26, 380	Chisel LEXER	263
CANFIELD Tonsil Knives	466	Chisel Mini-LAMBOTTE	262
CAPLAN Nasal Forceps	428	Chisel Novotex	264
Capsular Forceps ARRUGA	391	Chisel OBWEGESER	463
Capsular Forceps CASTROVIEJO	391	Chisel SMITH-PETERSEN	261
Capsular Forceps ELSCHNIG	391	Chisel STILLE	260
Capsular Forceps FUCHS	391	Chisels ALEXANDER	259
Capsular Forceps GILL-ARRUGA	390	Cilia Forceps ANMUTH	395
Capsular Forceps HESS	391	Cilia Forceps BARRAQUER	395
Capsular Forceps KALT	391	Cilia Forceps BEER	395
Capsular Forceps SCHWEIGGER	391	Cilia Forceps DOUGLAS	395
Capsular Forceps TERSON	391	Cilia Forceps GRADLE	395
Capsular Grasping Forceps MILLIN	551	Cilia Forceps LITTAUER	395
CAROLL Tendon Seizing Instrument	293	Cilia Forceps Planet ANMUTH	395
CARPENTER Elevator	465	Cilia Forceps Portal ANMUTH	395
Cartilage Knives	47	CINELLI Osteotome	441
CASPAR Hemostats	258	Circular Forceps	432
CASPAR Retractors	179, 180	CITELLI Rongeur	430
CASTANEDA Neonatal Vascular Clamp	527	Clamp Vasectomy	557
CASTROVIEJO Bladebreaker	45	Clamps Hysterectomy	126
CASTROVIEJO Caliper	380	CLAR Head Lights	22
CASTROVIEJO Capsular Forceps	391	CLARK Eye Specula	370
CASTROVIEJO Cyclodialysis Spatula	379	CLAUS Tonsil Needle	466

**Index**  
**Indice**  
**Indice**

CLAYMAN Implant Instrument Hook	376	Corneal Knife GILL	373
Cleaning Pistol	626	Corneal Knife SATO	373
CLEVELAND Bone Rongeur	235	Corneal Knife TOOK	373
Clip Applier Forceps	524	Corneal Sclerotome KUHNT	373
Clip Applying Forceps	326	CORONAL Brow Retractor	198
Clip Forceps CHILDE	224	CORWIN-HEGAR Wire Twisting Forceps	319
Clip Forceps COLLIN	224	CORYLLOS Retractor	166
Clip Forceps MICHEL	224	CORYLLOS Rib Scissors	480
Clip Forceps RICHTER-HEATH	224	COS Micro Ear Forceps	414
Clip Tissue Forceps HEGENBARTH	224	COTTLE Columella Tissue Forceps	448
Clip Tissue Forceps MICHEL	224	COTTLE Bulldog Scissors	56
Clip Tissue Forceps WACHENFELDT	224	COTTLE Fixation Forceps	410
Clips for Open Surgery 25°	525	COTTLE Hammer	273
Clips MICHEL	224	COTTLE Nasal Scissors	59
CLOWARD Lamina Spreader	339	COTTLE Nasal Specula	423
CLOWARD Laminectomy Rongeur	342	COTTLE Osteotome	440
CLOWARD Retractors	178	COTTLE Retractor	447
COAKLEY Antrum Curette	449	COTTLE Scissors	56
COAKLEY Trocar	204	COTTLE Septum Elevator	439
Coarctation Clamps DEBAKEY	507	COTTLE Septum Knives	435
COBB Curette	252	COTTLE Skin Hook	447, 448
COBB Gouges	262	COTTLE-JOSEPH Septum Elevator	439
COBB Raspatory	280	COTTLE-KAZANJIAN Bone Cutting Forceps	241
COLCLOUGH Intervertebral Disc Rongeur	344	COTTLE-NEIVERT Retractor	448
Cold Light Guide Clamp for Amnioscope	601	Cotton & Dressing Pliers LONDON-COLLEGE	93
Cold Light Guide HOLINGER	37	Cotton Applicator ANMUTH	203
Cold Light Guide JACKSON	37	Cotton Applicator FARRELL	203
College Pliers MERIAM	93	Cotton Applicator JOBSON-HORNE	203
COLLIER Needle Holder	208	Cotton Applicator TOBOLD	203
COLLIER Pelvimeter	605	Cotton Applicator UCKERMANN	203
COLLIN Abdominal Retractors	190	COXETER Metal Catheter	555
COLLIN Bowel Grasping Forceps	539	CRAFOORD Hemostatic Clamp	118
COLLIN Clip Forceps	224	CRAFOORD Lung Scissors	65
COLLIN Dressing Forceps	137	CRAFOORD-SELLORS Hemostatic Clamp	118
COLLIN Dynamometer	25	Cranial Punch CONE	331
COLLIN Hammer	270	Cranioplast BRAUN	607
COLLIN Loktite Retractor	191	Cranioplast TARNIER	607
COLLIN Pelvimeter	605	CREGO Elevator	282
COLLIN Retractor	139	CRILE Hemostatic Forceps	107
COLLIN Tissue Grasping Forceps	110	CRILE Needle Holder	213
COLLIN Tongue Forceps	453	CRILE Nerve Hook	328
COLLIN Umbilical Clamp	605	CRILE Retractor	140
COLLIN Uterine Grasping Forceps	585	CRILE-MURRAY Needle Holder	209
COLLIN Uterine Probes	586	CRILE-RANKIN Hemostatic Forceps	107
COLLIN Vaginal Specula	570	CRILE-WOOD Needle Holder	209
COLLIN-DUVAL Grasping Forceps	85	CRILE-WOOD Needle Holder TC	209
COLLIN-HARTMAN Retractor	141	CRITCHETT Eye Specula	370
Columella Tissue Forceps COTTLE	448	Crown Scissors BEEBEE	68
COLVER Tonsil Forceps	467	CRUTCHFIELD Cervical Traction Tong	327
Comedone Extractor SAALFELD	608	Cuff for Leg	295
Comedone Extractor SCHAMBERG	608	Cuff for Upper Arm	295
Comedone Extractor UNNA	608	CULLER Iris Spatula	378
Comedone Extractor WALTON	608	Curette ANTRUM	435
CONE Cranial Punch	330	Curette COBB	252
CONE Curette	280	Curette FAULKNER	449
CONNIN-AMSLER Markers	380	Curette HOUSE	420
CONVERSE Nasal Hook	448	Curette VOLKMANN D/E	257
CONVERSE Septum Knives	435	CUSCO Vaginal Specula	570, 571
COOLEY Anastomosis Clamp	518, 522	CUSHING Brain Spatula	336, 369
COOLEY Aortic Dilator	528	CUSHING Dressing and Tissue Forceps	83
COOLEY Catheter Forceps	510	CUSHING Drill	299
COOLEY Neonatal Rib Spreader	485	CUSHING Laminectomy Rongeurs	340
COOLEY Retractor	148	CUSHING Nerve Hook	328
COOLEY Rib Spreader	487	CUSHING Retractor	151 to 153
COOLEY Vascular Clamp	518, 522	CUSHING-TAYLOR Bayonet Forceps TC	87
COOLEY-DERRA Anastomosis Clamp	519	Cuticle Nipper	610
COOLY Suction Tube	28	CUZZI Ovum Curette	606
COOPER Ligature Needle	219	Cyclodialysis Spatula BANGERTER	379
CORDES Interchangeable Tips	472	Cyclodialysis Spatula CASTROVIEJO	379
Corneal Dissector GREEN	374	Cyclodialysis Spatula ELSCHNIG	379
Corneal Dissector PATON	373	Cyclodialysis Spatula WHEELER	379
Corneal Knife ELSCHNIG	373	Cystotome BECKER	375



**Index**  
**Indice**  
**Indice**

Cystotome GRAEFE	375	DIAMOND Pin Cutter	317
CZERNY Rectal Specula	559	DIEFFENBACH Vascular Clamp	104
CZERNY Tenaculum	584	DIETER Micro Ear Forceps	414
D		DIETHRICH Blood Vessel Clamp	510
DANDY Hemostatic Clamp	109	DIETHRICH Mini Bulldog Clamp	101
DANDY Nerve Hook	328	DIETHRICH Vascular Scissors	60
DARLING Retractors	178	Dilation Bougie DITTEL	554
DARTIGUES Uterine Grasping Forceps	585	Dilation Bougie GUYON	554
DASTOOR Strabismus Tissue Forceps	386	Dilation Bougie VAN BUREN	554
DASTOOR Suction Tube	380	DINGMAN Bone Holding Forceps	246
DAUBENSPECK Bone Curettes	255	DINGMAN Mouth Gag	456
DAVIDSON Scapula Retractor	166	DINGMAN Raspatory	463
DAVIEL Cataract Curette	377	DINGMAN Retractor	463
DAVIS Dura Dissector	331	DIPLOMAT Sphygmomanometer	5
DAVIS Foreign Body Needle	374	Dissecting Scissors DEEVER	52
DAVIS Sterilization Tissue Forceps	227	Dissecting Scissors JORGENSEN	53
DAVIS-BOYLE Mouth Gag	455	Dissecting Scissors LEXER	53
DAVIS-MEYER Mouth Gag	458	Dissecting Scissors LEXER-BABY	53
DAY Hook	409	Dissecting Scissors LEXER-BABY TC	53
DE BOER Rib Spreader	486	Dissecting Scissors MAYO	52
DE LEE Obstetrical Forceps	602	Dissecting Scissors MAYO TC	52
DE LUXE Diagnostic Set	20	Dissecting Scissors MAYO-NOBLE	52
DE MARTEL Guide Sleeve	329	Dissecting Scissors MAYO-STILLE	52
DE MARTEL-WOLFSON Anast Clamp	546	Dissecting Scissors MAYO-STILLE TC	52
DEAN Iris Knives	372	Dissecting Scissors METZENBAUM	53
DEAN Tonsil Scissors	59	Dissecting Scissors METZENBAUM FINO	53
DEEVER Dissecting Scissors	52	Dissecting Scissors METZENBAUM FINO TC	53
DEEVER Retractor	145	Dissecting Scissors METZENBAUM TC	53
DEEVER-GRIP Retractor	146	Dissecting Scissors PECK-JOSEPH	74
DEBAKEY Aortic Anast Clamp	505	Dissecting Scissors TOENNIS-ADSON	64
DEBAKEY Atraumatic Bulldog Clamp	100, 103	Dissection Knives BERENS	372
DEBAKEY Atraumatic Tissue Forceps	99	Dissection Knives BOWMAN	372
DEBAKEY Coarctation Clamps	507	Dissection Knives CASTROVIEJO	372
DEBAKEY Mosquito Hemostatic Clamp	509	Dissection Knives JAEGER	372
DEBAKEY Needle Holder	210	Dissection Knives WHEELER	373
DEBAKEY Suction Tube	28	Dissection Knives ZIEGLER	373
DEBAKEY Vascular Clamps	493 to 500, 507, 514 to 517	Dissection Needle BOWMAN	374
DEBAKEY Vascular Dilator	529	Dissector FISCH	420
DEBAKEY Vascular Scissors	60, 61	Dissector GORNEY	277
DEBAKEY-BAHNSON Cardio Clamp	506	Dissector PENFIELD	333
DEBAKEY-DIETHRICH Mini Bulldog Clamp	101	DITTEL Urethral Sounds	554
DEBAKEY-PEAN Atraumatic Clamp	513	DIX Foreign Body Chisels	374
DEBAKEY-RANKIN Atraumatic Clamp	512	DIX Foreign Body Instrument	380
DEBAKEY-SATINSKY Tangential Clamp	502	DOLPHIN NOSE Pliers	316
Decapitating Hook BRAUN	607	DOUGLAS Cilia Forceps	395
DEJERINE Percussion Hammer	24	DOUGLAS Tonsil Knife	466
DELEE Retractor	574	DOUGLAS Trocar	204
DEMEL Wire Guide Needle	315	DOYEN Abdominal Retractors	190
DEMEL Wire Instrument	315	DOYEN Gynecological Scissors	63
DENHART Mouth Gags	454	DOYEN Intestinal Forceps	540
DENIS-BROWNE Abdominal Retractors	185	DOYEN Myoma Screw	594
DERF Needle Holder	208	DOYEN Probes	199
Dermatome HUMBY	50	DOYEN Raspatory	278
Dermatome SCHINK	49	DOYEN Retractor	163
Dermatome SILVER	50	DOYEN Scissors	63
DESCHAMPS Ligature Needle	218	DOYEN Towel Clamp	133
DESJARDINS Gall Stone Curette	534	DOYEN Uterine Polyp Forceps	585
DESJARDINS Gall Stone Forceps	531	DOYEN Vaginal Specula	574
DESJARDINS Gall Stone Probe	532	DOYEN-BABY Intestinal Forceps	540
DESJARDINS Hemostatic Clamp	121	DOYEN-JANSEN (MOLT) Mouth Gag	454
DESMARRES Chalazion Tissue Forceps	393	DOYEN-STILLE Retractor	167
DESMARRES Retractor	151	Dressing Forceps	81 to 89
DEUTSCHMANN Cataract Knives	371	Dressing Forceps BOZEMAN	138
DEVILBISS Head Forceps	331	Dressing Forceps BOZEMAN-DOUGLAS	138
DEWECKER Eye Scissors	75	Dressing Forceps BRYANT	137
Diagnostic Set DE LUXE	20	Dressing Forceps CHERON	137
Diagnostic Set ECONOM	16	Dressing Forceps COLLIN	137
Diagnostic Set RI-MINI	17	Dressing Forceps GROSS-MAIER	134
Diagnostic Set RI-SCOPE	19	Dressing Forceps LISTER (SINUS)	137
Diagnostic Set RI-STAR	18	Dressing Forceps MAIER	134
Diagnostic Set UNI III	15	Dressing Forceps PELKMANN	137
		Dressing Forceps RAMPLEY	136

**Index  
Indice  
Indice**

Dressing Forceps SIMS-MAIER	134	Elevator LUNIATSCHEK	465
Dressing Forceps Sponge	134 to 138	Elevator McDONALD	283
Dressing Forceps ULRICH	135	Elevator MURPHY-LANE	283
Drill CUSHING	299	Elevator SAYRE	281
Drill ERRICO	299	Elevator WATSON-CHEYNE	283
Drill McKENZIE	299	ELLIOT Obstetrical Forceps	602
Drill Support for KIRSCHNER	299	ELLIS Foreign Body Gouges	374
Driver KUENTSCHER	321	ELSCHNIG Capsular Forceps	391
Drivers	321	ELSCHNIG Corneal Knife	373
DUBOIS Gynecological Scissors	63	ELSCHNIG Cyclodialysis Spatula	379
DUPLAY Dressing (Sponge) Forceps	134	ELSCHNIG Fixation Forceps	389
DUPLAY Tenaculum	582	EMMETT Fistula Hook	594
DUPLEX Stethoscope	23	Endoscope Retractor/Holder	188
DUPUY-WEISS Tonsil Knives	466	Endoscope Wire Basket	623
DURA Dissector	332	Endoscopic Arm System	188, 189
Dura Dissector DAVIS	332	Endospeculum KOGAN	577
Dura Dissector FRAZIER	333	ENGEL Plaster Cast Saw	229
Dura Dissector HOEN	333	ENGLISH Anvil Nail Splitting Forceps	613
Dura Dissector HORSLEY	333	Entropium Forceps SNELLEN	393
Dura Dissector MILLIGAN	332	Enucleation Curette WELLS	378
Dura Dissector OLIVECRONA	332	Epiglottis Retractor REICHERT	471
Dura Dissector SACHS	332	Episiotomy Scissors BRAUN-STADLER	64
Dura Dissector TOENNIS	332	Episiotomy Scissors WALDMANN	64
Dura Dissector WOODSON	333	EPPENDORFER Biopsy Forceps	590
DURA Hook	335	ESMARCH Bandage Scissors	69
Dura Hook ADSON	328	ESMARCH Plaster Knives	233
Dura Hook JACOBSON	335	ETHICON Type Clip Forceps	524
Dura Knives KOOS	335	EVES Tonsil Snare	468
Dura Scissors SCHMIEDEN-TAYLOR	65	Evisceration Curette BUNGE	378
DURANTE Grasping Tissue Forceps	88	EXACTA Sphygmomanometer	8
DUVAL Bowel Grasping Forceps	539	Extension Bow BOEHLER	312
DUVAL Grasping Tissue Forceps	85	Extension Bow KIRSCHNER	312
Dynamometer COLLIN	25	Extension Bow KIRSCHNER US	312
E		Extraction Dissector LANG	378
Ear Catheter HARTMAN	408	Extraction Hook for Ortho Nails	322
Ear Curette GROSS	409	Eye Cannula SCHEIE	394
Ear Curettes BUCK	407	Eye Cannula Type HAMBURG	394
Ear Forceps HARTMAN	411	Eye Cannula Type TUEBINGEN	394
Ear Forceps HEYMANN-KNIGHT	425	Eye Dressing Forceps	382
Ear Forceps JANSEN	424	Eye Magnet ANMUTH	395
Ear Forceps LITTAUER	411	Eye Scissors BARRAQUER	75
Ear Forceps LUCAE	410	Eye Scissors DEWECKER	75
Ear Forceps TILLEY	411	Eye Scissors NOYES	75
Ear Forceps TROELTSCH	424	Eye Scissors VANNAS	79
Ear Forceps WILDE (TROELTSCH)	410	Eye Scissors WESTCOTT	75
Ear Hook ZAUFAL	409	Eye Specula ARRUGA	370
Ear Hook ZAUFAL-JANSEN	409	Eye Specula BARRAQUER	370
Ear Knives POLITZER	408	Eye Specula BOWMAN	370
Ear Knives SEXTON	408	Eye Specula CASTROVIEJO	371
Ear Loop BILLEAU	409	Eye Specula CLARK	370
Ear Loop SHAPLEIGH	410	Eye Specula CRITCHETT	370
Ear Probes STACKE	199	Eye Specula GRAEFE	370
Ear Specula BOUCHERON	399	Eye Specula LANCASTER	371
Ear Specula BRUENINGS	401	Eye Specula LISTER-BURCH	370
Ear Specula GRUBER	399	Eye Specula MELLINGER	370
Ear Specula HARTMAN	399	Eye Specula MELLINGER-AXENFELD	370
Ear Specula POLITZER	399	Eye Specula MUELLER	371
Ear Specula RICHNAU-HOLMGREN	400	Eye Specula MURDOCK	370
Ear Specula SIEGLE	402	Eye Specula PARK	371
Ear Specula TOYNBEE	399	Eye Specula SMITH	370
Ear Syringe Parts	406	Eye Specula STEVENSON	371
Ear Syringe REINER	406	Eye Specula WEEK	370
ECHLIN Bone Rongeur	240	Eye Specula WILLIAMS	370
ECONOM Diagnostic Set	16	Eye Specula ZIEGLER	371
Elevator ALDERDYCE	282	Eye Suction Irrigation Cannula	394
Elevator BOIES	277	F	
Elevator CREGO	282	Face Lift Scissors FREEMAN	74
Elevator DINGMAN	463	Face Lift Scissors GORNEY	73
Elevator FREER	434	Face Lift Scissors KAYE	73
Elevator KEY	282	Face Lift Scissors REES	73
Elevator LEMPert	420	FANSLER Proctoscope	565

**Index**  
**Indice**  
**Indice**

FARABEUF Bone Holding Forceps	243	Foreign Body Instrument DIX	380
FARABEUF Periosteal Elevator/Rasp	274	Foreign Body Lever BUCK	412
FARABEUF Retractor	139	Foreign Body Lever QUIRE	412
FARABEUF-COLLIN Periosteal Elevator/Rasp	274	Foreign Body Needle DAVIS	374
FARABEUF-LAMBOTTE Bone Holding Forceps	243	Foreign Body Needle FRANCIS	374
FARRELL Cotton Applicator	203	Foreign Body Needle LA FORCE	374
FARRIOR Ear Specula	400	Foreign Body Needle LEVINSON	374
FAULKNER Curette	449	FOX Lupus Curette	608
FAURE Biopsy Forceps	588	Fracture Pins	308, 309
FAURE Peritoneum Clamp	123	FRAENKEL Interchangeable Tips	472
FAVALORO Vascular Scissors	61	FRAENKEL Laryngeal Polypus Forceps	471
FEHLAND Intestinal Forceps	542	FRANCIS Foreign Body Needle	374
FEILCHENFELD Splinter Forceps	91	FRANKLIN-SILVERMANN Biopsy Needle	206
FELDHEIM Bone Holding Clamp	249	FRAZIER Abdominal Retractors	181
FERGUSON Bone Holding Forceps	243	FRAZIER Dura Dissector	333
FERGUSON Gall Stone Curette	533	FRAZIER Skin Hook	149
FERGUSON Hemorrhoidal Clamp	109	FRAZIER Suction Tube	336
FERGUSON Surgical Scissors	66	FREEMAN Face Lift Scissors	74
FERGUSON-FRAZIER Suction Tube	336	FREEMAN Retractor	198
FERRIERA Plastic Surgery Retractor	197	FREER Elevator	434
FERRIS-SMITH Laminectomy Rongeur	343	FREER Septum Chisels	439, 442
FERRIS-SMITH Tissue Forceps	84	FREER Septum Elevator	437
FERRIS-SMITH-KERRISON Rongeur	344	FREER Septum Knives	434
Fiberglass Light Guide KLEINSASSER	36	FREER Skin Hook	448
Finger Goniometer	25	FRENZEL Tongue Depressors	451
Finger Nail Drill	297	FRIEDMANN Mini Bone Rongeur	234
Finger Protector LANGENBECK	311	FRIEDMANN Specula	577
Finger Ring Saw ANMUTH	297	FRITSCH Retractor	163
Finger Ring Saw WALTON	297	FRYKHOLM Bone Rongeur	240
Finger Saw LANGENBECK	296	FUCHS Capsular Forceps	391
FINNOCHIETTO-BABY Rib Spreader	482		
FINOCCHIETTO Bronchus Clamp	490	<b>G</b>	
FINOCCHIETTO Needle Holder	211	Galea Hook YASARGIL	330
FINOCCHIETTO Rib Spreaders	482, 484	Gall Bladder Scissors THOREK	65
FINSEN Retractor	168	Gall Duct Dilator BAKES	532
FISCH Dissector	420	Gall Stone Curette DESJARDINS	534
FISCH Fine Hook	335	Gall Stone Curette FERGUSSON	533
FISCHER Iris Tissue Forceps	384	Gall Stone Curette LUER-KOERTE	533
FISH Probes	199	Gall Stone Curette MAYO	534
FISHER Tonsil Knives	466	Gall Stone Curette MOOR	532
Fistula Hook EMMETT	594	Gall Stone Forceps BLAKE	531
Fistula Probes LOCKHART-MUMMERY	200	Gall Stone Forceps DESJARDINS	531
Fistula Probes PRATT	564	Gall Stone Forceps MAYO-BLAKE	531
Fixation Forceps BARRAQUER	390	Gall Stone Forceps MIXTER	531
Fixation Forceps CASTROVIEJO	390	Gall Stone Probes DESJARDINS	532
Fixation Forceps COTTLE	410	Gall Stone Probes MAYO	534
Fixation Forceps ELSCHNIG	389	Gall Stone Probes MOYNIHAN	532
Fixation Forceps GRAEFE	389	GALLAHER Antrum Rasp	446
Fixation Forceps GREEN	390	GASS Hook	376
Fixation Forceps LESTER	389	GAUSS Scalp Forceps	605
Fixator BURCH	373	GELPI Abdominal Retractors	190
Flat Nose Ortho Pin Pliers	316, 317	GEMINI Hemostatic Clamp	115
FLETCHER Sponge forceps	136	GERALD Dressing and Tissue Forceps	86, 87
Flexible Neck Retractors	150	GERSTER Bone Holding Clamp	250
FOERSTER Iris Tissue Forceps	383	GERZOG Hammer	270
FOERSTER Sponge Forceps	136	GIGLI Saw and Wire	332
FOMON Nasal Rasp	444	GILL Corneal Knife	373
FOMON Nasal Rasp	277	GILL Iris Tissue Forceps	384
FOMON Nasal Scissors	58	GILL-ARRUGA Capsular Forceps	390
FOMON Rhinoplasty Scissors	65	GILL-HESS Iris Tissue Forceps	384
FOMON Septum Chisels	441	GILLIES Needle Holder	212
FOMON Skin Hook	447	GILLIES Skin Hook	448
FOMON TC Nasal Rasps	445	GILLIES Tissue Forceps	86
FOREGGER Laryngoscope	29, 31	GIL-VERNET Retractor	152
Foreign Body Chisels DIX	374	GLOVER Bulldog Clamp	103
Foreign Body Curette ALVIS	374	GLOVER Vascular Clamp	515
Foreign Body Forceps HARTMAN	412	GLUCK Rib Scissors	480
Foreign Body Forceps HARTMAN-HOFFMANN	412	GOELET Retractor	141
Foreign Body Forceps HARTMAN-WULLSTEIN	412	GOLDMAN-FOX Gum Scissors	67
Foreign Body Forceps MATHIEU	556	GOMMEL Micro Scissors	80
Foreign Body Gouges ELLIS	374	GOMMEL Micro Tissue Forceps	96
Foreign Body Gouges WALTON	374	Goniometer MOELTGEN	25

**Index**  
**Indice**  
**Indice**

Goniotomy Knives BARKAN	373	H	
Goniotomy Knives SCHEIE	373	HABERER Bowel Spatula	143
GOOD Tonsil Scissors	59	HAGLUND-STILLE Plaster Retractor	232
GOODELL Uterine Dilator	581	HAIGHT Rib Spreader	487
GORNEY Dissector	277	HAJEK Hammer	273
GORNEY Face Lift Scissors	73	HAJEK Septum Chisels	442
GOSSET Abdominal Retractors	181	HAJEK-BALLENGER Elevator	439
Gouges PARTSCH	259	HAJEK-KOFLER Rongeur	429, 431
Gouges COBB	262	HALLE Bone Curettes	253
Gouges HIBBS	265	HALLE Septum Elevator	437
Gouges LEXER Mini	263	HALSEY Needle Holder	208
Gouges Novotex	264	HALSTED Mosquito Hemostatic Forceps	105
Gouges STILLE	260	HAMBURG Eye Cannula	394
Gouges WEST	442	Hammer BERGMANN	272
Gouges ZIELKE	264	Hammer COLLIN	270
GOURDET Uterine Curette	599	Hammer COTTLE	273
GRADLE Cilia Forceps	395	Hammer GERZOG	270
GRADLE Scissors	57	Hammer HAJEK	273
Graduated Medicine Cup	621	Hammer HEATH	273
GRAEFE Scissors Angled	56	Hammer KIRK	270
GRAEFE Cataract Curette	377	Hammer LUCAE	271
GRAEFE Cataract Knives	371	Hammer MEAD	271
GRAEFE Cystotome	375	Hammer OMBREDANNE	273
GRAEFE Dissection Knives	372	Hammer PARTSCH	271
GRAEFE Fixation Forceps	389	Hammer QUISLING	271
GRAEFE Skin Hook	149	Hammer WILLIGER	271
GRAEFE Strabismus Hook	375	Handle for Chisels/Osteotomes	266
GRAEFE Tissue Forceps	83	Handle for Lane Screw Drivers	324
GRAFFE Eye Specula	370	Handle for Rotating Biopsy Punches	591
GRAHAM Nerve Hook	328	Handle Scalpel	38 to 40
GRAIG Septum Forceps	426	Handle Scalpel Mini	41
Grasping Forceps for Pins/Wires	316	Handles for Bone Drill	300
Grasping Forceps LAHEY	479	HANK Uterine Dilator	580
Grasping Forceps MARTEL	110	HARKEN Auricle Clamp	503
Grasping Forceps Micro Ear	415	HARMS Trabeculotomy Probe	381
Grasping Forceps PRATT	110	HARRINGTON Bronchus Clamp	490
Grasping Forceps WILLET-MARTEL	110	HARRINGTON Retractor	147
Grasping Tissue Forceps COLLIN-DUVAL	85	HARTMAN Ear Catheter	408
Grasping Tissue Forceps DUVAL	85	HARTMAN Ear Specula	399
GRAVES Vaginal Specula	570	HARTMAN Foreign Body Forceps	412
GRAY Hemostatic Clamp	121	HARTMAN Foreign Body Lever	411
GREEN Corneal Dissector	374	HARTMAN Hemostatic Forceps	104
GREEN Fixation Forceps	390	HARTMAN Irrigation Cannula	433
GREEN Muscle Hook	375	HARTMAN Nasal Specula	422, 427
GREEN Retractor	160	HARTMAN Polyp Forceps	424
GREEN-ARMYTAGE Forceps	605	HARTMAN Tongue Depressors	452
GREVEN Micro Ear Forceps	414	HARTMAN Tuning Fork	403
Grooved Directors	199	HARTMAN-HALLE Nasal Specula	421
GROSS Ear Curette	409	HARTMAN-HOFFMANN Foreign Body Forceps	412
GROSS-MAIER Dressing Forceps	134	HARTMAN-WULLSTEIN Foreign Body Forceps	412
GRUBER Ear Specula	399	HAUGH Micro Ear Forceps	414
Guide Driver	321	HAYES Rectal Anastomosis Clamp	545
Guide Needle REDON	207	Head Light CLAR Complete	22
Guide Probes KOENIG	221	Head Mirror ZIEGLER	21
Guide Probes BRUNNER	221	HEANEY Hysterectomy Clamp	126
Guide Probes KIRSCHNER	221	HEANEY Needle Holder	210
Guide Probes SCHMIEDEN	221	HEANEY Biopsy Curette	587
Guide Probes SCHMIEDEN-PAYR	221	HEANEY Retractor	164
GUILLEN Suction Raspatory	433	HEANEY-BALLENTINE Hysterectomy Clamp	127
Gum Scissors GOLDMAN-FOX	67	HEATH Hammer	273
Gum Scissors LOCKLIN	68	HEATH Suture Scissors	66
Gum Scissors QUIMBY	67	HEBRA Chalazion Curette	377
GUTHRIE Skin Hook	149	HEGAR Uterine Dilator	578, 579
GUYON Catheter Guide	554	HEGENBARTH Clip Forceps	224
GUYON Dilation Bougie	554	HEIFETZ Brain Spatula	369
GUYON Kidney Clamp	122	HEISS Hemostatic Clamp	112
GUYTON-LUNDSSGAARD Sclerotome	373	HEISTER Mouth Gags	454
Gynecological Scissors DOYEN	63	Hemorrhoidal Clamp FERGUSSON	109
Gynecological Scissors DUBOIS	63	Hemorrhoidal Forceps HEYWOOD-SMITH	567
Gynecological Scissors SIEBOLD	62	Hemorrhoidal Forceps McGIVNEY	568
Gynecological Scissors SIMS	62	Hemorrhoidal Ligator McGIVNEY	568
Gynecological Scissors WERTHEIM	62	Hemorrhoidal Ligator RUDD	568

**Index**  
**Indice**  
**Indice**

Hemostatic Clamp ADSON	112	HIRSCHMANN Anoscope	563
Hemostatic Clamp ADSON-BABY	113	HOEN Dura Dissector	333
Hemostatic Clamp BAINBRIDGE	120	HOESEL Needle Holder	213
Hemostatic Clamp BENGOLEA	112	HOESEL Retractor	167
Hemostatic Clamp BIRKETT	116	HOFER Retractor	465
Hemostatic Clamp CRAFOORD	118	HOFFMANN Tubing Clamp	624
Hemostatic Clamp CRAFOORD-SELLORS	118	HOHMANN Mini Retractor	286
Hemostatic Clamp CRILE	107	HOHMANN Retractor	284, 285
Hemostatic Clamp CRILE-RANKIN	107	HOKE Chisels	265
Hemostatic Clamp DANDY	109	Holding Arm LEYLA	368
Hemostatic Clamp DEBAKEY Mosquito	509	Holding Clamp ADSON	298
Hemostatic Clamp DEBAKEY-PEAN	513	HOLINGER Laryngoscope	37
Hemostatic Clamp DEBAKEY-RANKIN	512	HOLINGER Light Guide	37
Hemostatic Clamp DESJARDINS	121	HOLSHER Nerve Hook	329
Hemostatic Clamp GEMINI	115	HOLTH Rongeur	380
Hemostatic Clamp GRAY	121	HOLZBACH Hysterectomy Clamp	126
Hemostatic Clamp GUYON	122	HOLZHEIMER Retractor	168
Hemostatic Clamp HALSTED Mosquito	105	Hook BARBARA	419
Hemostatic Clamp HARTMAN	104	Hook DAY	409
Hemostatic Clamp HARTMAN Micro	104	Hook FISCH	335
Hemostatic Clamp HEISS	112	Hook GASS	376
Hemostatic Clamp JACOBSON	105	Hook LUCAE	409
Hemostatic Clamp JOHNS-HOPKINS	120	Hook McGEE	419
Hemostatic Clamp KANTROWITZ	119	Hook SINSKEY	376
Hemostatic Clamp KELLY	106	Hook SMELLIE	605
Hemostatic Clamp KELLY-RANKIN	106	Hook STEVENS	375
Hemostatic Clamp KOCHER	108	Hook WAGENER	409
Hemostatic Clamp LAHEY	120	Hooks Ear	419
Hemostatic Clamp LAWRENCE	119	HOPKINS Plaster Knives	233
Hemostatic Clamp LERICHE	111	HORIZON Type Clip Forceps	524
Hemostatic Clamp LOVELACE	109	HORSLEY Dura Dissector	333
Hemostatic Clamp LOWER	120	HOUSE Curette	420
Hemostatic Clamp MAYO-GUYON	122	HOUSE Suction Tube	337
Hemostatic Clamp MEEKER	119	HOWARTH Septum Elevator	438
Hemostatic Clamp MIXTER	116, 119 to 121	HUBER Universal Handle	472
Hemostatic Clamp MIXTER-BABY	119	HUDSON Bone Hand Drills	299
Hemostatic Clamp MOYNIHAN	121	HUDSON Dressing Forceps	82
Hemostatic Clamp O'SHAUGNESSY	120	HUDSON T-Handle	300
Hemostatic Clamp OVERHOLT	114	HUDSON Tissue Forceps	82
Hemostatic Clamp OVERHOLT-BABY	114	HULKA Tenaculum	583
Hemostatic Clamp OVERHOLT-GEISSENDÖRFER	114	HUMBY Dermotome	50
Hemostatic Clamp OVERHOLT-MIXTER	115	HUNTER Splinter Forceps	91
Hemostatic Clamp PEAN	108, 110	HURD Tonsil Elevator	465
Hemostatic Clamp PENNINGTON	109	Hypophyseal Curette	334
Hemostatic Clamp PROVIDENCE-HOSPITAL	106	Hypophyseal Tissue Forceps ADSON	334
Hemostatic Clamp ROBERTS	117	Hysterectomy Clamp HEANEY	126
Hemostatic Clamp ROCHESTER-CARMALT	109	Hysterectomy Clamp HEANEY-BALLENTINE	127
Hemostatic Clamp ROCHESTER-OCHSNER	108	Hysterectomy Clamp ROGERS	127
Hemostatic Clamp ROCHESTER-PEAN	108	Hysterectomy Clamp SEGOND	125
Hemostatic Clamp RUMEL	117	Hysterectomy Clamp SEGOND-LANDAU	125
Hemostatic Clamp SAROT	118	Hysterectomy Clamp WERTHEIM	124, 128
Hemostatic Clamp SPENCER-WELLS	109	Hysterectomy Forceps WERTHEIM-CULLEN	125
Hemostatic Clamp STILLE	122	Hysterectomy Scissors WERTHEIM	63
Hemostatic Clamp TOENNIS	117		
Hemostatic Clamp ZENKER	118	I	
Hemostats Bone	258, 259	Impactor/Extractor	322
HENKE Tonsil Elevator	465	Implant Instrument KUGLEN	376
HENLEY Retractors	170	IMPLANT Mallet	272
HENNIG Plaster Retractor	232	INGE Lamina Spreader	339
HEPP-SCHEIDEL Micro Scissors	78	Injection Cannula	36
HERCULES Bandage Scissors	69	Instrument Box/Case	617
HERRICK Clamp	123	Instrument Holder BUNT	227
HESS Capsular Forceps	391	Insufflation Cannula VERESS	206
HESS Iris Tissue Forceps	384	Interchangeable Tips BARACANI	472
HEYMANN Septum Forceps	425	Interchangeable Tips BRUENINGS	472
HEYMANN Nasal Scissors	58	Interchangeable Tips CORDES	472
HEYMANN-KNIGHT Ear Forceps	425	Interchangeable Tips FRAENKEL	472
HEYWOOD-SMITH Hemorrhoidal Forceps	567	Interchangeable Tips KRAUSE	472
HIBBS Chisels	265	Interchangeable Tips LANGE	472
HIBBS Gouges	265	Interchangeable Tips SCHEINMANN	472
HIBBS Retractor	164	Interchangeable Tips SCHUMACHER	472
HILL-FERGUSON Rectal Specula	560	Interchangeable Tips SEIFERT	472

**Index  
Indice  
Indice**

Intervertebral Disc Rongeur COLCLOUGH	344	JARCHO Tenaculum	583
Intestinal Forceps Atraumatic	539	JAVID Carotid Shunt Clamp	511
Intestinal Forceps BABY-KOCHER	540	JENNINGS Mouth Gags	454
Intestinal Forceps BRUNNER	543	JEWELERS TYPE Type Forceps	90
Intestinal Forceps DOYEN	540	JOBSON-HORNE Cotton Applicator	203
Intestinal Forceps FEHLAND	542	JOHNS-HOPKINS Applier Forceps	104
Intestinal Forceps KOCHER	540	JOHNS-HOPKINS Bulldog Clamp	104
Intestinal Forceps MAYO-ROBSON	541	JOHNS-HOPKINS Hemostatic Forceps	120
Intestinal Forceps RESANO	542	JOHNSON Needle Holder	211
Intestinal Forceps SCUDDER	541	JONES Towel Clamp	132
Intestinal Forceps STONE-WATT	545	JONES-CLIP Towel Clamp	132
Intramedullary Pins	322	JORGENSEN Dissecting Scissors	53
Intraocular Micro Forceps	396	JOSEPH (LEWIS) Nasal Rasp	443
IOWA Needle Guide	206	JOSEPH Nasal Saw	446
IOWA Tenaculum	584	JOSEPH Periosteal Elevator	277
Iris Hook O'CONNOR	375	JOSEPH Septum Elevator	437
Iris Hook WIENER	375	JOSEPH Septum Knives	434, 435
Iris Knives DEAN	372	JOSEPH Skin Hook	149
Iris Knives KNAPP	372	JOSEPH Surgical Scissors	54
Iris Knives ZIEGLER	372	JUDD-ALLIS Bowel Grasping Forceps	538
IRIS Scissors	54	JUDD-MASSON Bladder Retractors	552
Iris Scissors KNAPP	55	JUERS Micro Ear Forceps	414
Iris Scissors LITTLER	55	JURASZ Laryngeal Polyp Forceps	471
Iris Spatula CULLER	378		
Iris Spatula WECKER	378	K	
IRIS Supercut Scissors	72	KABIERSKE Powder Blower	405
Iris Tissue Forceps	382	KALLMORGEN Specula	573
Iris Tissue Forceps BARRAQUER-KATZIN	384	KALT Capsular Forceps	391
Iris Tissue Forceps BISHOP-HARMON	386	KALT Needle Holder	214
Iris Tissue Forceps BONN	387	KALT-ARRUGA Needle Holder	214
Iris Tissue Forceps FISCHER	384	KAMBO Hammer	270
Iris Tissue Forceps FOERSTER	383	KANE Umbilical Clamp	605
Iris Tissue Forceps GILL	384	KANTROWITZ Hemostatic Forceps	119
Iris Tissue Forceps GILL-HESS	384	KAYE Face Lift Scissors	73
Iris Tissue Forceps HESS	384	KEINSASSER Laryngoscope	35
Iris Tissue Forceps KIRBY-ARTHUR	385	KEITH Needle	223
Iris Tissue Forceps STEVENS	383	KELLY Hemostatic Clamp	106
Iris Tissue Forceps TROUTMAN	384, 389	KELLY Proctoscope	563, 564
Iris Tissue Forceps Type TUEBINGEN	387	KELLY Retractor	164
Irrigation Cannula HARTMAN	433	KELLY Uterine Polyp Forceps	585
Irrigation Cannula KILLIAN	433	KELLY Vascular Scissors	61
Irrigation Cannula RITTER-HALLE	433	KELLY-GRIP Retractor	142
Irrigation Cannula SIEBENMANN	433	KELLY-RANKIN Hemostatic Clamp	106
Irrigation Cannula SIMCOE	394	Keratoplasty Knives BARRAQUER	373
Irrigation Cannula Type BONN	394	Keratoplasty Knives PAUFIQUE	373
ISRAEL Retractor	162	KERN Bone Holding Forceps	244
ITERSON Trachea Hook	477	KERRISON Rongeur	428
IUD Extraction Hook	593	KEVORKIAN Biopsy Curette	587
IUD Grasping Forceps Flexible SERPENTINE	593	KEVORKIAN Biopsy Forceps	589, 591
IVES-FANSLER Anoscope	563	KEVORKIAN-PACIFIC Biopsy Forceps	592
IWANSON Measuring Instrument	624	KEY Elevator	282
		Key for Chisel Handle	266
J		KEYES Dermal Biopsy Punch	608
JACKSON Laryngoscope	37	Kidney Clamp GUYON	122
JACKSON Polyp Forceps	471	Kidney Forceps HERRICK	123
JACKSON Tendon Seizing Forceps	292	Kidney Stone Forceps RANDALL	535
JACKSON Trachea Hook	476	Kidney Tray	619
JACKSON Vaginal Specula	573	KIELLAND Obstetrical Forceps	602
JACOBS Tenaculum	583	KIELLAND-LUIKART Obstetrical Forceps	603
JACOBSON Button Probes	335	KILLIAN Gouges	442
JACOBSON Curette	257	KILLIAN Irrigation Cannula	433
JACOBSON Dura Hook	335	KILLIAN Nasal Specula	423
JACOBSON Hemostatic Clamp	105	KILLIAN Septum Elevator	438, 439
JACOBSON Needle Holder	215	KILLIAN Septum Scissors	429
JAEGER Dissection Knife	372	KILLIAN-CLAUS Septum Gouges	442
JAEGER Lid Plate	371	KILNER Nasal Hook	447
JAMESON Strabismus Forceps	385	KILNER Needle Holder	212
JAMESON Strabismus Hook	375	KILNER Skin Hook	608
JANSEN Bone Curettes	257	KILNER Supercut Scissors	72
JANSEN Bone Rongeur	237	KILNER Surgical Scissors	54
JANSEN Ear Forceps	424	KILNER-DOUGHTY Mouth Gag	456
JANSEN Retractor	168	KIRBY-ARTHUR Iris Forceps	385

**Index  
Indice  
Indice**

KIRK Hammer	270	Lacrimal Dilator ZIEGLER	381
KIRSCHNER Abdominal Retractors	185, 187	Lacrimal Probes BOWMAN	381
KIRSCHNER Bone Drill	299	LAHEY Grasping Forceps	479
KIRSCHNER Extension Bow	312	LAHEY Hemostatic Clamp	120
KIRSCHNER Guide Probes	221	LAHEY Retractor	149, 157
KIRSCHNER K-Wire	306, 307	LAMBERT Chalazion Tissue Forceps	393
KIRSCHNER K-Wire Dispenser	310	LAMBERT-KAY Aortic Anastomosis Clamp	505
KIRSCHNER K-Wire Sterilization Holder	305	LAMBERT-LOWMAN Bone Holding Clamp	249
KIRSCHNER Nail Pins	308, 309	LAMBOTTE Bone Holding Forceps	244
KIRSCHNER Retractor Blades	187	LAMBOTTE Chisels	261
KLAPP Retractor	150	LAMBOTTE Periosteal Elevator	274, 275
KLEINERT-KUTZ Bone Rongeur	237	Lamina Spreader CLOWARD	339
KLEINERT-KUTZ Skin Hook	149	Lamina Spreader INGE	339
KLEINERT-KUTZ Tendon Seizing Instrument	294	Laminectomy Retractor CHERRY	488
KLEINSASSER Chest Support	36	Laminectomy Retractor SCOVILLE	196
KLEINSASSER Fiberglass Light Guide	36	Laminectomy Retractor SCOVILLE-HAVERFIELD	196
KLEINSASSER Injection Cannula	36	Laminectomy Rongeurs CLOWARD	342
KLEINSASSER Suction Tube	36	Laminectomy Rongeurs CUSHING	340
KLEINSCHMIDT Appendix Intestinal Forceps	544	Laminectomy Rongeurs FERRIS-SMITH	343
KLINKENBERGH-LOTH Scissors	65	Laminectomy Rongeurs LOVE-GRUENWALD	340
KNAPP Cataract Spoon	378	Laminectomy Rongeurs OLDBERG	341
KNAPP Extraction Hook	375	Laminectomy Rongeurs SCHLESINGER	342
KNAPP Iris Knives	372	Laminectomy Rongeurs SPURLING	340
KNAPP Iris Scissors	55	Laminectomy Rongeurs WAGNER	343
KNAPP-LUER Trachoma Forceps	393	LANCASTER Eye Specula	371
KNIGHT Septum Forceps	425	LANCETTE Electrode Monopolar	628, 629
Knives Amputation	44	LANDAU Vaginal Specula	577
Knives BALLENGER	436	LANDHOLT Tumor Grasping Forceps	341
Knives Bone	44	LANE Bender	325
Knives MUCK	420	LANE Bone Holding Forceps	244
Knives PLESTER	418	LANE Bone Levers	290
Knives ROSEN	418	LANE Bone Plate Holding Forceps	325
Knives SCHUKNECHT	418	LANE Screw Driver	323, 324
Knives TABB	418	LANE Screw Holding Forceps	325
Knives WULLSTEIN	418	LANE Stomach Clamp	547
KNOWLES Bandage Scissors	70	LANE Tissue Forceps	84
KOCHER Bladder Spatula	552	LANE Towel Clamp	133
KOCHER Hemostatic Clamp	108	LANE-TRETHOWAN Bone Levers	290
KOCHER Intestinal Forceps	540	LANG Extraction Dissector	378
KOCHER Probes	479	LANGE Interchangeable Tips	472
KOCHER Retractor	155, 160, 163	LANGE Nasal Hook	448
KOCHER-LANGENBECK Retractor	159	LANGE-HOHMANN Bone Lever	286
KOENIG Bone Levers	284	LANGENBECK Amputation Knives	44
KÖENIG Guide Probes	221	LANGENBECK Bone Holding Forceps	243
KOENIG Needle	223	LANGENBECK Ear Loop	409
KOENIG Raspatory	276	LANGENBECK Finger Protector	311, 409
KOENIG Retractor	153	LANGENBECK Finger Saw	296
KOERTE Retractor	162	LANGENBECK Knives	47
KOGAN Endospecula	577	LANGENBECK Needle Holder	213
KOOS Dura Knives	335	LANGENBECK Raspatory	275
KRAUSE Interchangeable Tips	472	LANGENBECK Retractor	158, 159
KRAUSE Polyp Snare	411, 434	LANGENBECK-GREEN Retractor	153
KRAUSE-VOSS Polyp Snare	434	LARSEN Tendon Seizing Forceps	292
KRAYENBUEHL Nerve Hook	336	Laryngeal Forceps Micro	474
KRISTELLER Specula	572	Laryngeal Mirror MICHEL	423
KRISTELLER Vaginal Specula	572	Laryngeal Mirrors	473
KROENIG Tongue Depressors	451	Laryngeal Polypus Forceps FRAENKEL	471
KRONECKER Ligature Needle	219	Laryngeal Polypus Forceps JURASZ	471
KUENTSCHER Driver	321	Laryngoscope Cold Light Guide Battery Handle	33
KUENTSCHER Extractor	322	Laryngoscope FOREGGER	29, 31
KUENTSCHER Reamer	321	Laryngoscope HOLINGER	37
KUGLEN Implant Instrument	376	Laryngoscope JACKSON	37
KUHNT Corneal Sclerotome	373	Laryngoscope McINTOSH	29, 31
KUMMEL Intestinal Retractor	144	Laryngoscope MILLER	30
		Laryngoscope Warm Light Battery Handle	32
L		Lateral Vaginal Retractor	569
LA FORCE Adenoid Curette	450	Latex O Rings	568
LA FORCE Foreign Body Needle	374	LAWRENCE Hemostatic Clamp	119
Label Holder for Steri Tray	623	Lead Hand	250
LABORDE Trachea Dilator	476	LEBSCHKE Sternum Chisel	267
Lacrimal Dilator CASTROVIEJO	381	LEES Bronchus Clamp	504
Lacrimal Dilator WILDER	381	LEGUEU Bladder Retractors	553

**Index**  
**Indice**  
**Indice**

LEGUEU Bladder Spatula	552	LUER Bone Rongeur	236
LEKSELL (STILLE) Bone Rongeur	240	LUER Retractor	140
LELAND-JONES Vascular S Clamp	494	LUER Trachea Cannula	479
LEMPERT Bone Curettes	256	LUER-KOERTE Gall Stone Curette	533
LEMPERT Bone Rongeur	237	LUIKART Obstetrical Forceps	603
LEMPERT Elevator	420	LUNDSGAARD Sclerotome	373
LERCHE Grasping Tissue Forceps	83	Lung Grasping Forceps LOVELACE	490
LERICHE Abdominal Spatula	144	Lung Scissors CRAFOORD	65
LERICHE Hemostatic Clamp	111	Lung Spatula ALLISON	489
LERICHE Intestinal Retractor	144	LUNIATSCHEK Tonsil Instrument	465
LESTER Fixation Forceps	389	Lupus Curette FOX	608
LEVINSON Foreign Body Needle	374	Lupus Curette PIFFARD	608
LEWIN Bone Holding Forceps	246		
LEWIS Nasal Rasp	443	<b>M</b>	
LEXER BABY Dissecting Scissors	53	MAGILL Catheter Introducing Forceps	28
LEXER Chisels	263	MAIER Dressing Forceps	134
LEXER Dissecting Scissors	53	MALTZ (COTTLE) Nasal Rasp	444
LEXER Mini Gouges	263	MALTZ Nasal Rasp	443
LEYLA Holding Arm	368	Manometer for Tourniquet	295
LICHTENBERG Needle Holder	213	Markers CONNIN-AMSLER	380
LICHTWITZ Cannula	433	MARQUARDT Bone Rongeur	239
LICHTWITZ Trocar	204	MARSCHIK Tonsil Forceps	468
Lid Plate JAEGER	371	MARTEL Grasping Forceps	110
Ligature Needle COOPER	219	MARTIN Bone Holding Forceps	246
Ligature Needle DESCHAMPS	218	MARTIN Pelvimeter	605
Ligature Needle KRONECKER	219	MARTIN Uterine Sound	586
Ligature Needle NELSON	219	MARTINI Bone Curettes	257
Ligature Needle SCHMIEDEN-DICK	219	MASSING-NEIVERT Nasal Hook	447
Ligature Rings	568	MASSON Needle Holder	210
Light Guide	37	MASTIN Muscle Clamp	479
Light Guide Cold Light Guide JACKSON	37	MATHIEU Foreign Body Forceps	556
Light Guide HOLLINGER	37	MATHIEU Needle Holder	213
LINDSAY Hammer	272	MATHIEU Rectal Specula	560
Lip and Cheek Retractors	453	MATHIEU Retractor	141
LISTER (SINUS) Dressing Forceps	137	MATHIEU-OLSEN Needle Holder	212
LISTER Bandage Scissors	69	MATSON Raspatory	279
LISTER Supercut Scissors	72	MATSON-ALEXANDER Raspatory	279
LISTER-BURCH Eye Specula	370	MAXI GRASPER Biopsy Forceps	593
LISTON Amputation Knives	44	MAY Ophthalmoscope Head for UNI II	14
LISTON Bone Cutting Forceps	241	MAYFIELD Bone Rongeur	238
LITTAUER Cilia Forceps	395	MAYO Dissecting Scissors	52
LITTAUER Ear Forceps	411	MAYO Dissecting Scissors TC	52
LITTAUER Polyp Forceps	425	MAYO Gall Stone Curette	534
LITTAUER Suture Scissors	66	MAYO Gall Stone Probes	534
LITTLE Retractor	157	MAYO Instrument Holder	227
LITTLER Iris Scissors	55	MAYO Supercut Scissors	71
LITTLEWOOD Bowel Grasping Forceps	538	MAYO Tissue Forceps	89
LOCKHART-MUMMERY Fistula Probes	200	MAYO Tongue Depressors	451
LOCKLIN Gum Scissors	68	MAYO Wire Twister	319
LOCKWOOD-ALLIS Bowel Grasping Forceps	538	MAYO-ADAMS Retractors	171
LONDON-COLLEGE Cotton & Dressing Pliers	93	MAYO-BLAKE Gall Stone Forceps	531
Loop Electrodes Monopolar	628, 629	MAYO-COLLINS Retractor	141
LOPEZ-REINKE Tonsil Elevator	465	MAYO-HABERISSER Wire Forceps	319
LORENZ Bandage Scissors	70	MAYO-HEGAR Needle Holder	209
LORNA Towel Clamp	133	MAYO-HEGAR Needle Holder TC	209
LOUTE Wire Instrument	315	MAYON-GUYON Hemostatic Clamp	122
LOVE Nerve Hook	329, 330	MAYO-NOBLE Dissecting Scissors	52
LOVE Retractor	465	MAYO-ROBSON Intestinal Forceps	541
LOVE-GRUENWALD Rongeur	340	MAYO-STILLE Dissecting Scissors	52
LOVELACE Hemostatic Clamp	109	MAYO-STILLE Supercut Scissors	71
LOVELACE Lung Grasping Forceps	490	McCULLOUGH Strabismus Forceps	385
LOWER Hemostatic Clamp	120	MCDONALD Elevator	283
LOWMAN Bone Holding Clamp	249	McGEE Hook	419
LOWMAN-HOGLUND Bone Holding Clamp	249	McGEE Micro Ear Forceps	414
LUBET-BARBON Nasal Dressing Forceps	424	McGIVNEY Grasping Forceps	568
LUC Septum Forceps	426	McGIVNEY Hemorrhoidal Ligator	568
LUCAE Ear Forceps	410	McGIVNEY Latex Rings	568
LUCAE Hammer	271	McGIVNEY Loading Cone	568
LUCAE Hook	409	McINDOE Bone Cutting Forceps	241
LUCAE Paracentesis Needle	408	McINDOE Scissors	65
LUCAE Tuning Fork	404	McINDOE Tissue Forceps	85
LUCAS Chisel/Gouge	260	McINTOSH Laryngoscope	29, 31



**Index**  
**Indice**  
**Indice**

McIVOR Mouth Gags	457	MILLIN Bladder Retractors	552
McKENTY Septum Elevator	437, 438	MILLIN Bladder Spreader	553
McKENZIE Applying Forceps	326	MILLIN Capsular Grasping Forceps	551
McKENZIE Drill	299	MILLIN Prostatic Grasping Forceps	551
McLEAN Obstetrical Forceps	603	Mini Bulldog Clamps	101
McLEAN-LUIKART Obstetrical Forceps	603	Mini Bulldog Clamp DEBAKEY -DIETHRICH	101
McLEAN-TUCKER-LUIKART Obstetrical Forceps	603	Mini Quick Handle	301
McPHERSON Tissue Forceps	392	Mini Scalpel	41
MEAD Bone Rongeur	235	Mini Scalpel Handle	41
MEAD Hammer	271	MINI-LAMBOTTE Osteotomes	262
Measuring Caliper CASTROVIEJO	380	MINIMUS Sphygmomanometer	11, 12
Measuring Caliper IWANSON	624	MINI-TOWNSEND Biopsy Punch	591
Medicine Cups, Jars, Trays	620, 621	MINI-TOWNSEND-DOWN Biopsy Punch	591
MEEKER Hemostatic Clamp	119	MINI-TOWNSEND-UP Biopsy Punch	591
MEHDORN Applier Forceps	362	MIXTER Clamp S Curve	116
MEHDORN Vascular Clip	362	MIXTER Gall Stone Forceps	531
MELLINGER Eye Specula	370	MIXTER Hemostatic Clamp	116, 119 to 121
MELLINGER-AXENFELD Eye Specula	370	MIXTER-BABY Hemostatic Clamp	119
MENGHINI Biopsy Needle	206	MIXTER-O'SHAUGNESSY Hemostatic Clamp	120
Meniscus Hook BLOUNT	289	MOELTGEN Goniometer	25
Meniscus Knives NEFF	292	MOGEN Circumcision Clamp	556
Meniscus Knives SMILLIE	292	MOLLISON Retractors	171
MERCEDES Thoracic Spreader	489	MOLT Mouth Gag	454
MERIAM College Pliers	93	MOLT Raspatory	276
Metal Catheter COXETER	555	Monopolar Electrode Ball	628, 629
Metal Catheters	555	Monopolar Electrode Loops	628, 629
Metal Ruler	25	Monopolar Electrode Needles	628, 629
METZENBAUM Dissecting Scissors	53, 54	MOOR Gall Stone Curette	532
METZENBAUM Dissecting Scissors TC	53	MOORE Bone Hand Drills	298
METZENBAUM FINO Dissecting Scissors TC	53	MOORFIELD Tissue Forceps	392
METZENBAUM Needle Holder	211	MORGAN Proctoscope	562
METZENBAUM Supercut Scissors	71	MORITZ-SCHMIDT Tongue Depressors	452
MEYERDING Finger Retractors	157	MORRIS- DEBAKEY Aortic Forceps	506
MEYERDING Loktite Retractor	180	MORRIS Retractor	164
MEYHOEFER Chalazion Curette	377	MORSE Rib Spreader	484
MICHEL Clip Forceps	224	MORSE-FAVALORO Rib Spreader	484
MICHEL Clips	224	Mouth Gags DAVIS-BOYLE	455
MICHEL Laryngeal Mirror	423	Mouth Gags DENHART	454
Micro Cannula WULLSTEIN	338	Mouth Gags DINGMAN	456
Micro Ear Forceps COS	414	Mouth Gags DOYEN-JANSEN (MOLT)	454
Micro Ear Forceps DIETER	414	Mouth Gags HEISTER	454
Micro Ear Forceps GREVEN	414	Mouth Gags JENNINGS	454
Micro Ear Forceps HAUGH	414	Mouth Gags McIVOR	457
Micro Ear Forceps JUERS	414	Mouth Gags ROSER-KOENIG	454
Micro Ear Forceps McGEE	414	MOYNIHAN Gall Stone Probes	532
Micro Ear Forceps WULLSTEIN	416	MOYNIHAN Hemostatic Clamp	121
Micro Ear Scissors BELLUCCI	413	MOYNIHAN Towel Clamp	133
Micro Ear Scissors SHEA	413	MUCK Knives	420
Micro FRIEDMANN Bone Rongeur	234	MUELLER Approximator	364
Micro Grasping Forceps	415	MUELLER Eye Specula	371
Micro HARTMAN Hemostatic Clamp	104	MUELLER Vascular Clip	365
Micro Instrument Steri Case	616	Multi Purpose Clamps DEBAKEY	508
Micro Scissors	76 to 78, 80	MURDOCK Eye Specula	370
Micro Scissors ANMUTH	77, 78, 80	MURPHY Retractor	156
Micro Scissors BELLUCI	417	MURPHY-LANE Elevator	283
Micro Scissors GOMEL	80	Muscle Clamp MASTIN	479
Micro Scissors HEPP-SCHUIDEL	78	Muscle Forceps PRINCE	387
Micro Tissue Forceps	94	Muscle Hook	267
Micro Tissue Forceps ADSON-BROWN (OWEN)	96	Muscle Hook GREEN	375
Micro Tissue Forceps GOMEL	96	Muscle Forceps BERKE	389
Micro Tissue Forceps Intraocular	396	MUSEUX Tenaculum	583
Micro Tissue Forceps VICKERS	97	MYLES Nasal Forceps	427
Micro Vascular Needle Holder	210	Myoma Knives SEGOND	594
MIDDELDORPF Retractor	160	Myoma Screw DOYEN	594
MIDDLETON-JANSEN Septum Forceps	430		
MIKULICZ Intestinal Forceps	543	N	
MIKULICZ Peritoneum Clamp	123	NABATOFF Varicose Vein Probes	201
MIKULICZ Retractor	163	NAEGELE Obstetrical Forceps	602
MIKULICZ-BABY Peritoneum Clamp	123	NAGER Retractor	465
MILLER Bone Rasps	444	NAGER Tonsil Needle	466
MILLER Laryngoscope	30	Nail Brushes	611
MILLIGAN Dura Dissector	332	Nail Curettes	612

**Index**  
**Indice**  
**Indice**

Nail Drill	297	Needle Holder LICHTENBERG	213
Nail File	610	Needle Holder MASSON	210
Nail Impactor	322	Needle Holder MATHIEU	213
Nail Nippers	609	Needle Holder MATHIEU-OLSEN	212
Nail Nippers and Splitters	609, 613, 614	Needle Holder MAYO-HEGAR	209
Nail Rasp	610	Needle Holder METZENBAUM	211
Nail Scissors	609, 614	Needle Holder Micro Vascular	210
Nail Set	609	Needle Holder NEIVERT	208
Nasal Cutting Scissors	429	Needle Holder OLSEN-HEGAR	212
Nasal Dressing Forceps LUBET-BARBON	424	Needle Holder RYDER	210
Nasal Dressing Forceps WESTMACOTT	424	Needle Holder SAROT	211
Nasal Forceps CAPLAN	428	Needle Holder STEVENS	214
Nasal Forceps HARTMAN	427	Needle Holder STRATTE	212
Nasal Forceps MYLES	427	Needle Holder WANGENSTEEN	210
Nasal Forceps SCHMEDEN	427	Needle Holder WEBSTER	208
Nasal Forceps STRUYCKEN	427	Needle REVERDIN	220
Nasal Forceps TAKAHASHI	427	Needle ROSEN	419
Nasal Forceps WATSON-WILLIAMS	428	Needle Sterilization Case SAUERBRUCH	615
Nasal Forceps WEIL-BLAKESLEY	426	Needle YOUNG-BOOMERANG	220
Nasal Hook CONVERSE	448	NEFF Meniscus Knives	292
Nasal Hook LANGE	448	NEGUS Chest Support	459
Nasal Olive POLITZER	406	NEIVERT Needle Holder	208
Nasal Rasp FOMON	444, 445	NELATON Probes	199
Nasal Rasp JOSEPH (LEWIS)	443	NELSON (STANDARD) Trocar	204
Nasal Rasp MILLER	444	NELSON Ligature Needle	219
Nasal Rasp PEET	446	NELSON Trocar	205
Nasal Rasp WIENER	443	NELSON Vascular Tissue Forceps	88
Nasal Rasp MALTZ (COTTLE)	444	Neonatal Atraumatic Vascular Clamps	523
Nasal Saw JOSEPH	446	Neonatal Vascular Clamp CASTANEDA	527
Nasal Scissors COTTLE	59	Nerve Hook CRILE	328
Nasal Scissors FOMON	58	Nerve Hook CUSHING	328
Nasal Scissors HEYMANN	58	Nerve Hook DANDY	328
Nasal Specula ANMUTH	423	Nerve Hook GRAHAM	328
Nasal Specula COTTLE	423	Nerve Hook HOLSHER	329
Nasal Specula HARTMAN	422	Nerve Hook KRAYENBUEHL	336
Nasal Specula HARTMAN-HALLE	421	Nerve Hook LOVE	329, 330
Nasal Specula KILLIAN	423	Nerve Hook SACHS	328
Nasal Specula THUDICHUM	421	Nerve Hook SCOVILLE	329, 330
Nasal Specula TIECK-HALLE	423	Nerve Hook SMITHWICK	328
Nasal Specula VIENNA	421	NEUGS Tonsil Forceps	467
Nasal Specula VOLTOLINI	421	Neuro Surgical Scissors STRULLY	64
Needle BARBARA	419	NEWS Trachea Hook	477
Needle Guide IOWA	206	NISSEN Hemostatic Clamp	113
Needle Holder ADSON	211	No Scalpel Vasectomy Instruments	557
Needle Holder ARRUGA	214	Noise Appartus POLITZER	405
Needle Holder BABY-OLSEN-HEGAR	212	NORFOLK-NORWICH Retractors	172
Needle Holder BABY-WEBSTER	208	NORTHBENT Suture Scissors	66
Needle Holder BARRAQUER	216, 217	NOTO Uterine Polyp Forceps	585
Needle Holder BARRAQUER-TROUTMAN	216	NOVA Sphygmomanometer	6, 7
Needle Holder BAUMGARTNER	208	NOVAK Biopsy Curette	587
Needle Holder BOYNTON	214	NOYES Eye Scissors	75
Needle Holder BOZEMANN	211	NOYES Polyp Forceps	425
Needle Holder BROWN	209	Nurses Stethoscope	23
Needle Holder CASTROVIEJO	215, 216		
Needle Holder CASTROVIEJO Micro	215	O	
Needle Holder COLLIER	208	Obstetrical Curette SELLHEIM	607
Needle Holder CRILE	213	Obstetrical Forceps BARTON	603
Needle Holder CRILE-MURRAY	209	Obstetrical Forceps BOERMA	604
Needle Holder CRILE-WOOD	209	Obstetrical Forceps DE LEE	602
Needle Holder DEBAKEY	210	Obstetrical Forceps ELLIOT	602
Needle Holder DERF	208	Obstetrical Forceps KIELLAND	602
Needle Holder FINOCCHIETTO	211	Obstetrical Forceps KIELLAND-LUIKART	603
Needle Holder GILLIES	212	Obstetrical Forceps LUIKART	603
Needle Holder HALSEY	208	Obstetrical Forceps McLEAN	603
Needle Holder HEANEY	210	Obstetrical Forceps McLEAN-LUIKART	603
Needle Holder HOESEL	213	Obstetrical Forceps McLEAN-TUCKER	603
Needle Holder JACOBSON	215	Obstetrical Forceps McLEAN-TUCKER-LUIKART	603
Needle Holder JOHNSON	211	Obstetrical Forceps NAEGELE	602
Needle Holder KALT	214	Obstetrical Forceps PIPER	604
Needle Holder KALT-ARRUGA	214	Obstetrical Forceps SIMPSON	602
Needle Holder KILNER	212	Obstetrical Forceps SIMPSON-BRAUN	602
Needle Holder LANGENBECK	213	Obstetrical Forceps SIMPSON-LUIKART	603

**Index**  
**Indice**  
**Indice**

Obstetrical Forceps WRIGLEY	602	Penis Clamp STOCKMANN	556
OBWEGESER Awl	463	Penis Clamp STRAUSS	556
OBWEGESER Elevators	462, 463	PENNINGTON Hemostatic Clamp	109
OBWEGESER Raspatory	462	PENNINGTON Septum Elevator	438
OBWEGESER Retractors	460, 461	Percussion Hammer BABINSKY	24
OCHSNER Trocar	205	Percussion Hammer BERLINER	24
O'CONNOR Iris Hook	375	Percussion Hammer BUCK	24
OEHLER Tissue Forceps	81	Percussion Hammer TAYLOR	24
OLDBERG Laminectomy Rongeurs	341	Percussion Hammer TROEMNER	24
OLIVECRONA Bone Rongeur	237	PERCY Retractor	296
OLIVECRONA Brain Spatula	336	Perforators SMELLIE	607
OLIVECRONA Dura Dissector	332	Periosteal Elevators	274 to 283
OLIVECRONA Wire	332	Peripheral Vascular Clamp DEBAKEY	494
OLIVECRONA-TOENNIS Applier Forceps	326	Peripheral Vascular Clamp LELAND-JONES	494
OLLIER Retractor	162	Peritoneum Clamp FAURE	123
OLSEN-HEGAR Needle Holder	212	Peritoneum Clamp MIKULICZ	123
OMBREDANNE Hammer	273	Peritoneum Clamp MIKULICZ-BABY	123
Operating Scissors	51	Peritoneum Clamp PHANEUF	123
Ophthalmoscope MAY UNI II	14	PERKINS Retractors	168
Ophthalmology Scissors AEBLI	58	PERTHES Awl	304
Ophthalmology Scissors GRADLE	57	PESTALOZZA Ovum Curette	606
Ophthalmology Scissors STEVENS	58	Phalangeal Knives	44
OP-Laryngoscope HOLINGER	37	PHANEUF Peritoneum Clamp	123
OP-Laryngoscope JACKSON	37	PIERCE Septum Elevator	438
OP-Laryngoscope KLEINSASSER	35	PIERCE Trocar	204
Oscillating Plaster Cast Saw	230	PIFFARD Lupus Curette	608
Osteotome CINELLI	441	Pin Cutter	320
Osteotome COTTLE	440	Pin STEINMANN	307
Osteotome SHEEHAN	441	PINARD Stethoscope	23
Osteotome SILVER	442	Pinwheel WARTENBERG	25
OSTROEM Antrum Punch	430	PIPER Obstetrical Forceps	604
O'SULLIVAN-O'CONNOR Abdominal Retractor	181	Plaster Cast Saw Electric	230
O'SULLIVAN-O'CONNOR Vaginal Retractor	576	Plaster Cast Saw ENGEL	229
OTIS Urethrotome	553	Plaster Forceps WOLFF	233
Otoscope UNI I	13	Plaster Knives ESMARCH	233
OVERHOLT Hemostatic Clamp	114	Plaster Knives HOPKINS	233
OVERHOLT Raspatory	279	Plaster Knives REINER	233
OVERHOLT-BABY Hemostatic Clamp	114	Plaster Knives WIGMORE	229
OVERHOLT-GEISENDOERFER Hemostatic Clamp	114	Plaster Scissors STILLE	229
OVERHOLT-MIXTER Hemostatic Clamp	115	Plaster Spreader ANMUTH	232
Ovum Curette CUZZI	606	Plaster Spreader BEESON	232
Ovum Curette PESTALOZZA	606	Plaster Spreader HAGLUND-STILLE	232
Ovum Curette WALLICH	607	Plaster Spreader HENNIG	232
Ovum Forceps SAENGER	606	Plastic Hammer	271
Ovum Forceps WINTER	606	Platypus Nail Forceps	297
		PLEKMANN Dressing Forceps	137
<b>P</b>		PLESTER Knives	418
Paracentesis Needle LUCAE	408	PLESTER Retractors	171
Paracentesis Needle POLITZER	408	PLESTER Suction Tube	338
Parametrium Scissors	63	Pneumatic Tourniquet	295
PARK Eye Specula	371	POLITZER Air Blower	406
PARKER Retractor	139	POLITZER Ear Knives	408
Parts for Back Holder Abdominal Retractor Set	193 to 195	POLITZER Ear Specula	399
PARTSCH Chisels	259	POLITZER Nasal Olive	406
PARTSCH Hammer	271	POLITZER Paracentesis Needle	408
PASSOW Chisel	260	Polyp Forceps HARTMAN	424
Patella Forceps	248	Polyp Forceps JACKSON	471
PATON Corneal Dissector	373	Polyp Forceps LITTAUER	425
PAUFIQUE Keratoplasty Knives	373	Polyp Forceps NOYES	425
PAUFIQUE Tissue Forceps	392	Polyp Snare KRAUSE	411, 434
PAYR Guide Probes	221	Polyp Snare KRAUSE-VOSS	434
PAYR Pylorus Clamp	548	Polyp Snare WILDE	411, 434
PEAN Hemostatic Clamp	108, 110	POOLE Suction Tube	27
PECK-JOSEPH Dissecting Scissors	74	POST MORTEM Hammer	270
PEDERSON Vaginal Specula	570	Post Mortem Knife VIRCHOW	48
PEERS Towel Clamp	132	Post Mortem Needle	268
PEET Nasal Rasp	446	Post Mortem Set	269
PEET Splinter Forceps	92	POTTS Coarctation Clamps	492
Pelvimeter COLLIER	605	POTTS Vascular Clamps	493
Pelvimeter MARTIN	605	POTTS-DE MARTEL Vascular Scissors	59
Pelvis Hook St. MARKS	165	POTTS-SMITH Tissue Forceps	81
PENFIELD Dissector	333	POTTS-SMITH Vascular Scissors	61

**Index**  
**Indice**  
**Indice**

PRATT Fistula Probes	564	Razor Blades	45
PRATT Rectal Specula	559	Reamer KUENTSCHER	321
PRATT Tenaculum	584	RECAMIER Uterine Curette	597
PRATT T-Shape Tissue Forceps	110	Rectal Anastomosis Clamp HAYES	545
PRATT Uterine Dilator	580	Rectal Biopsy Forceps YEOMAN	566, 567
PRECISA Sphygmomanometer	9	Rectal Snare WESTON	566
PRICE-THOMAS Bronchus Clamp	490	Rectal Specula ALAN-PARKS	561
PRINCE Muscle Forceps	387	Rectal Specula BARR	559
PRINCE Tonsil Scissors	59	Rectal Specula BODENHAMMER	559
Probe and Packer	612	Rectal Specula CZERNY	559
Probe Tips	201	Rectal Specula HILL-FURGUSON	560
Probes BRODIE	199	Rectal Specula MATHIEU	560
Probes DOYEN	199	Rectal Specula PRATT	559
Probes FISH	199	Rectal Specula SAWYER	560
Probes KOCHER	479	Rectal Specula SCHULZE-BERGMANN	560
Probes NELATON	199	Rectal Specula SIMS	559
Probes VALLEIX	586	Rectal Suction Tube BUIE	566
Probes WATSON-CHEYNE	199	REDON Guide Needle	207
Probes, Directors	199	REES Face Lift Scissors	73
Proctoscope CHELSEA-EATON	564	REICHERT Epiglottis Retractor	471
Proctoscope FANSLER	565	REILL Bone Holding Forceps	248
Proctoscope KELLY	563, 564	REINER Ear Syringe	406
Proctoscope MORGAN	562	REINER Plaster Knives	233
Prostatic Grasping Forceps MILLIN	551	RESANO Intestinal Forceps	542
Prostatic Hook YOUNG	550	Resection Knives	47
PROVIDENCE-HOSPITAL Hemostatic Clamp	106	Retractor ADSON	172 to 174
Punch Biopsy KEYES	608	Retractor ADSON-BABY	173
Puncture Cannula LICHTWITZ	433	Retractor ALM	168
Puncture Cannula QUINKE	206	Retractor ANDERSON-ADSON	172
PUTTI Bone Rasp	294	Retractor Assembly	188
Pylorus Clamp PAYR	548	Retractor AUFRANC	289
Pylorus Spreader BENSON	544	Retractor AUFRICHT	447
		Retractor BABY-GOSSET	181
<b>Q</b>		Retractor BALFOUR	182
QUERVAIN Elevator	275	Retractor BALFOUR-BABY	182
Quick Action Handle	301	Retractor BECKMANN	176
QUIMBY Gum Scissors	67	Retractor BECKMANN-ADSON	175
QUINKE Puncture Cannula	206	Retractor BECKMANN-EATON	176
QUIRE Mechanical Finger	412	Retractor Blades BALFOUR-US	183, 184
QUISLING Hammer	271	Retractor Breast	198
		Retractor BRUNNER	167
<b>R</b>		Retractor CASPAR	179, 180
Rachiotome	267	Retractor CHARNLEY	289
RALK Bone Hand Drills	300	Retractor CLOWARD	178
RAMPLEY Dressing Forceps	136	Retractor COLLIN	139
RAMUS Retractor	461	Retractor COLLIN	190
RANDALL Biopsy Curette	587	Retractor COLLIN-HARTMAN	141
RANDALL Kidney Stone Forceps	535	Retractor COLLIN-LOKTITE	191
RANEY Applying Forceps	327	Retractor COOLEY	148
RANGELL Retractor	140	Retractor Coronal Brow	198
Raspatory ADSON	282	Retractor CORYLLOS	166
Raspatory ALEXANDER	276	Retractor COTTLE	447
Raspatory COBB	280	Retractor CRILE	140
Raspatory DINGMAN	463	Retractor CUSHING	151
Raspatory DOYEN	278	Retractor DARLING	178
Raspatory FARABEUF	274	Retractor DAVIDSON (Scapula)	166
Raspatory FARABEUF-COLLIN	274	Retractor DEAVER	145
Raspatory FOMON	277	Retractor DEAVER-GRIP	146
Raspatory JOSEPH	277	Retractor DELEE	574
Raspatory KOENIG	276	Retractor DENIS-BROWNE	185
Raspatory LAMBOTTE	274	Retractor DESMARRES	151
Raspatory LANGENBECK	275	Retractor DOYEN	163
Raspatory MATSON	279	Retractor DOYEN	190
Raspatory MATSON-ALEXANDER	279	Retractor DOYEN-STILLE	167
Raspatory MOLT	276	Retractor FARABEUF	139
Raspatory OBWEGESER	462	Retractor FERRIERA	197
Raspatory OVERHOLT	279	Retractor FINSEN	168
Raspatory SEDILLOT	274, 275	Retractor FRAZIER	181
Raspatory SEMB	278	Retractor FREEMAN	198
Raspatory WIBERG	277	Retractor FRITSCH	163
Raspatory WILLIGER	276	Retractor GELPI	190
Rasps and Elevators	279	Retractor GIL-VERNET	152

**Index  
Indice  
Indice**

Retractor GOELET	141	REYNOLDS Supercut Scissors	72
Retractor GOSSET	181	REYNOLDS Surgical Scissors	54
Retractor GREEN	160	Rhinoplasty Scissors FOMON	65
Retractor HARRINGTON	147	Rib Shears	480
Retractor HEANEY	164	Rib Shears BETHUNE	481
Retractor HENLEY	170	Rib Shears BRUNNER	481
Retractor HIBBS	164	Rib Shears CORYLLOS	480
Retractor HOESEL	167	Rib Shears GLUCK	480
Retractor HOFER	465	Rib Shears LAWRENCE	480
Retractor HOLZHEIMER	168	Rib Shears ROSS	480
Retractor ISRAEL	162	Rib Shears SAUERBRUCH	481
Retractor JANSEN	168	Rib Shears SAUERBRUCH-FREY	481
Retractor KELLY	164	Rib Shears STILLE	480
Retractor KELLY-GRIP	142	Rib Shears STILLE-GIERTZ	481
Retractor KIRSCHNER	185, 187	Rib Spreader BAILEY	489
Retractor KOCHER	155	Rib Spreader BAILEY-BABY	489
Retractor KOCHER	160, 163	Rib Spreader BAILEY-GIBBON	489
Retractor KOCHER-LANGENBECK	159	Rib Spreader BURFORD-FINOCCHIETTO	483
Retractor KOERTE	162	Rib Spreader COOLEY	487
Retractor KOENIG	153	Rib Spreader COOLEY Neonatal	485
Retractor LAHEY	157	Rib Spreader DE BOER	486
Retractor LANGENBECK	158, 159	Rib Spreader FINOCCHIETTO	482, 484
Retractor LITTLE	157	Rib Spreader HAIGHT	487
Retractor LOVE	465	Rib Spreader MORSE	484
Retractor MASING-NEIVERT	447	Rib Spreader MORSE-FAVALORO	484
Retractor MATHIEU	141	Rib Spreader RIENHOFF-FINOCCHIETTO	486
Retractor MAYO-ADAMS	171	Rib Spreader TUFFIER	487
Retractor MEYERDING	157, 177, 180	Ribbon Bowel Spatula	143
Retractor MIDDELDORPF	160	RIBBON Retractor	143
Retractor MIKULICZ	163	RICARD Abdominal Retractors	191
Retractor MOLLISON	171	RI-Cataract Diagnostic Set	18
Retractor MORRIS	164	RICHARDSON Retractor	142
Retractor MURPHY	156	RICHARDSON-EASTMAN Retractor	142
Retractor NAGER	465	RICHARDSON-GRIP Retractor	142
Retractor NORFOLK-NORWICH	172	RICHNAU-HOLMGREN Ear Specula	400
Retractor OBWEGESER	460, 461	RICHTER-HEATH Clip Forceps	224
Retractor OLLIER	162	RIENHOFF-FINOCCHIETTO Rib Spreader	486
Retractor PARKER	139	RIGBY Abdominal Retractors	190
Retractor PERCY	296	Rigid Neck Retractors	150
Retractor PERKINS	168	RI-MINI Diagnostic Set	17
Retractor PLESTER	171	RING Tongue Depressors	455
Retractor RAGNELL	140	RI-SCOPE Diagnostic Set	19
Retractor RAMUS	461	RITTER-HALLE Irrigation Cannula	433
Retractor RIBBON	143	ROBB Spatula	530
Retractor RICARD	191	ROBERTS Hemostatic Clamp	117
Retractor RICHARDSON	142	ROCHARD Abdominal Retractors	186
Retractor RICHARDSON-EASTMAN	142	ROCHESTER-CARMALT Forceps	109
Retractor RICHARDSON-GRIP	142	ROCHESTER-OCHSNER Forceps	108
Retractor RIGBY	190	ROCHESTER-PEAN Forceps	108
Retractor ROCHARD	186	ROEDER Towel Clamp	132
Retractor ROSE	140	ROGER Septum Elevator	437
Retractor ROUX	139	ROGERS Hysterectomy Clamp	127
Retractor ROUX-BABY	140	ROGGE Sterilization Forceps	227
Retractor ROUX-Mini	140	ROLLET Extraction Hook	375
Retractor SAUERBRUCH	164, 166	ROLLET Ophthalmic Chisels	374
Retractor SCALP-CONTOUR	169	Rongeur CITELLI	430
Retractor SENN	143	Rongeur FERRIS-SMITH-KERRISON	344
Retractor SENN-GREEN	153	Rongeur HAJEK-KOFLER	429, 431
Retractor SIMON	164	Rongeur HOLTH	380
Retractor SPINA-NASALIS	461	Rongeur KERRISON	428
Retractor TEBBETTS	197	ROSE Retractor	140
Retractor TESSIER Mouth	463	ROSEN Knives	418
Retractor TRAVERS	172	ROSEN Needle	419
Retractor TUFFIER	147	ROSEN Suction Tube	338
Retractor US-ARMY	141	ROSER-KOENIG Mouth Gag	454
Retractor VOLKMANN	153, 154	ROUX Retractor	139
Retractor WEITLANER	169	ROUX-BABY Retractor	140
Retractor WULLSTEIN	171	ROWE Forceps	459
Retractor YANCOSKIE	198	RUBIN Septum Forceps	428
Retractor ZENKER	161	RUDD Hemorrhoidal Ligator	568
REVERDIN Bowel Spatula	143	RUMEL Hemostatic Clamp	117
REVERDIN Needle	220	RUMEL-BELMONT Tourniquet	528

**Index**  
**Indice**  
**Indice**

RUSKIN Bone Cutting Forceps	241	Sclerotome LUNDGAARD	373
RUSKIN Bone Rongeur	238, 239	SCOVILLE Bone Curette	253
RUSKIN-LISTON Bone Cutting Forceps	241	SCOVILLE Laminectomy Retractor	196
RUSS MODELL Grasping Tissue Forceps	85	SCOVILLE Nerve Hook	329, 330
RUSSEL-DAVIS Mouth Gag	458	SCOVILLE-HAVERFIELD Laminectomy Retractor	196
RYDEL-SEIFFERT Tuning Fork	404	Screw Driver LANE	323
RYDER Needle Holder	210	Screw Driver WILLIAMS	323
<b>S</b>			
SAALFELD Comedone Extractor	608	SCUDDER Intestinal Forceps	541
SACHS Nerve Hook	328	SEBILEAU Elevator	275
SACHS Dura Dissector	332	SEDILLOT Periosteal Elevator/Rasp	274
SAENGER Ovum Forceps	606	SEGOND Hysterectomy Clamp	125
SANVENERO Surgical Scissors	54	SEGOND Myoma Knives	594
SAROT Hemostatic Clamp	118	SEGOND-LANDAU Hysterectomy Clamp	125
SAROT Needle Holder	211	SEIFERT Interchangeable Tips	472
SATINSKY Vascular Clamp	491	SELDIN Elevator	277
SATINSKY Vascular Scissors	65	SELLHEIM Obstetrical Curette	607
SATO Corneal Knife	373	SEMB Bone Cutting Forceps	242, 243
SATTERLEE Amputation Saw	296	SEMB Bone Rongeur	240
SAUERBRUCH Bone Rongeur	240	SEMB Bronchus Clamp	491
SAUERBRUCH Forceps	227	SEMB Raspatory	278
SAUERBRUCH Needle Sterilization case	615	SEMKEN Tissue Forceps	86
SAUERBRUCH Retractor	164, 166	SEMM Vaginal Specula	571
SAUERBRUCH Rib Scissors	481	SENN-GREEN Retractor	153
SAUERBRUCH-FREY Sternum Scissors	481	SENN-MILLER Retractor	143
Saw GIGLI	332	Septum Cannula	406
SAWTELL Tonsil Forceps	467	Septum Chisels FOMON	441
SAWYER Rectal Specula	560	Septum Chisels FREER	439
SAYRE Elevator	281	Septum Elevator BALLENGER	439
SCAGLIETTI Bone Rongeur	240	Septum Elevator COTTLE	439
SCALP-CONTOUR Retractors	169	Septum Elevator COTTLE-JOSEPH	439
Scalpel Blade Remover	42	Septum Elevator FREER	437
Scalpel Blades	42	Septum Elevator HAJEK-BALLENGER	439
Scalpel Handle Hollow	40	Septum Elevator HALLE	437
Scalpel Handle Mini	41	Septum Elevator HOWARTH	438
Scalpel Handles	38 to 40	Septum Elevator JOSEPH	437
Scalpel Mini	41	Septum Elevator KILLIAN	438
Scalpel Sterile	43	Septum Elevator McKENTY	437, 438
Scalpels	46	Septum Elevator PENNINGTON	438
SCHAEDEL Towel Clamp	132	Septum Elevator PIERCE	438
SCHAMBERG Comedone Extractor	608	Septum Elevator ROGER	437
SCHEDE Bone Curettes	251	Septum Forceps BRUENINGS	425
SCHEIE Eye Cannula	394	Septum Forceps HEYMANN	425
SCHEIE Goniotomy Knives	373	Septum Forceps KNIGHT	425
SCHEINMANN Interchangeable Tips	472	Septum Forceps LUC	426
SCHERBAK Vaginal Specula	575	Septum Forceps MIDDLETON-JANSEN	430
SCHIMMELBUSCH Steri Drum	622	Septum Forceps RUBIN	428
SCHINK Dermatome	49	Septum Gouges FREER	442
SCHIOETZ Tonometer	394	Septum Gouges HAJEK	442
SCHLESINGER Laminectomy Rongeurs	342	Septum Gouges KILLIAN-CLAUS	442
SCHMEDEN Nasal Forceps	427	Septum Knives CONVERSE	435
SCHMID Vascular Irrigation Cannula	338	Septum Knives COTTLE	435
SCHMIEDEN Guide Probes	221	Septum Knives FREER	434
SCHMIEDEN-DICK Ligature Needle	219, 221	Septum Knives JOSEPH	434, 435
SCHMIEDEN-TAYLOR Dura Scissors	65	Septum Scissors KILLIAN	471
SCHNIDT Tonsil Forceps	467	Septum Straightening Forceps ASCH	449
SCHOENBORN Thyroid Gland Hook	479	Septum Straightening Forceps WALSHAM	449
SCHROEDER (BRAUN) Tenaculum	582	SERPENTINE Biopsy Forceps	593
SCHROEDER (POZZI) Tenaculum	582	SEUTIN Bandage Scissors	69
SCHROEDER Tenaculum	583, 584	SEXTON Ear Knives	408
SCHROEDER Uterine Curette	595	SHAPLEIGH Ear Loop	410
SCHUBERT Biopsy Forceps	588	SHAVER Knives	49
SCHUKNECHT Knives	418	SHEA Micro Ear Scissors	413
SCHULZE-BERGMANN Rectal Specula	560	SHEEHAN Osteotome	441
SCHUMACHER Biopsy Forceps	588, 589	Shunt Clamp JAVID	511
SCHUMACHER Episiotomy Scissors	64	Sickle Knives ANMUTH	435
SCHUMACHER Interchangeable Tips	472	SIEBENMANN Irrigation Cannula	433
SCHUMACHER Sternum Scissors	481	SIEBOLD Gynecological Scissors	62
SCHWEIGGER Capsular Forceps	391	SIEGLE Ear Specula	402
Scissors	51 to 80	Silicon Mat for Steri Case	616
Sclerotome GUYTON-LUNDSGAARD	373	SILVER Dermatome	50
		SILVER Osteotome	442
		SIMCOE Irrigation Cannula	394

**Index  
Indice  
Indice**

SIMON Retractor	164	Spinal Hook TAYLOR	291
SIMON Uterine Curette	594	SPINA-NASALIS Retractor	461
SIMPLEX Cheek Retractor	453	Splinter Forceps ARCHER	92
SIMPLEX Tubing Clamp	624	Splinter Forceps CARMALT	91
SIMPSON Obstetrical Forceps	602	Splinter Forceps FEILCHENFELD	91
SIMPSON-BRAUN Obstetrical Forceps	602	Splinter Forceps HUNTER (CARMALT)	91
SIMPSON-LUIKART Obstetrical Forceps	603	Splinter Forceps PEET	92
SIMPSON-MARTIN Uterine Sound	586	Splinter Forceps STIEGLITZ	92
SIMS Gynecological Scissors	62	Splinter Forceps WALTER	91
SIMS Rectal Specula	559	Splinter Forceps VIRTUS (RALK)	92
SIMS Uterine Curette	597	Sponge Dressing Forceps	134 to138
SIMS Uterine Depressor	586	Sponge Forceps	136
SIMS Uterine Dilator	581	SPRATT Bone Curettes	251
SIMS Uterine Sound	586	Spreader CASPAR	197
SIMS Vaginal Specula	573	Spreader DAVIS-BOYLE	455
SIMS-MAIER Dressing Forceps	134	Spreader DAVIS-MEYER	458
SINGLEY Tissue Forceps	88	Spreader DINGMAN	456
Sinoscopy Forceps	431	Spreader KILNER-DOUGHTY	456
SINSKEY Hook	376	SPURLING Laminectomy Rongeurs	340
Sinus Probes	438	ST. CLAIR-THOMSON Adenoid Curette	450
SINUS Septum Elevator	438	ST. MARKS Pelvis Hook	165
Sinuscopy Trocar	205	ST. MARTIN Tissue Forceps	392
SISTRUNK Surgical Scissors	66	STACKE Ear Probes	199
SKENE Tenaculum	582	Stainless Steel Steri Wire Baskets	625
Skin Hook ANMUTH	150	Stainless Wire Basket for Endoscope	623
Skin Hook COTTLE	447, 448	STAMMBERGER Forceps	431
Skin Hook COTTLE-NEIVERT	448	STANDARD Surgical Scissors	51
Skin Hook FOMON	447	STAUDE-MOORE Tenaculum	582
Skin Hook FRAZIER	149	STEINMANN Pin	307, 308
Skin Hook FREER	448	STEINMANN Tendon Holding Forceps	292
Skin Hook GILLIES	448	STELLBRINK Bone Rongeur	234
Skin Hook GRAEFE	149	Sterile Scalpels	43
Skin Hook GUTHRIE	149	Sterilization Cases	618
Skin Hook JOSEPH	149	Sterilization Clamp BUNT	227
Skin Hook KILNER	608	Sterilization Clamp MAYO	227
Skin Hook KLEINERT-KUTZ	149	Sterilization Forceps ANMUTH	615
Skin Punch KEYES	608	Sterilization Forceps CHEATLE	227
Skin Scissors	610	Sterilization Forceps DAVIS	227
SLS Type Clip Forceps	524	Sterilization Forceps ROGGE	227
SLUDER-BALLENGER Forceps	470	Sterilization Forceps UNIVERSAL	227
SMELLIE Hook	605	Sterilization Tray	616, 618, 622
SMELLIE Perforators	607	Sterilizer Drums SCHIMMELBUSCH	622
SMILLIE Bone Levers	291	STERNBERG Cheek Retractor	453
SMILLIE Meniscus Knives	292	Sternum Chisels LEBSCHKE	267
SMITH Eye Specula	370	Sternum Scissors SCHUMACHER	481
SMITH US ARMY Bandage Scissors	69	Stethoscope DUPLEX	23
SMITH-BUIE ANAL Retractor	561	Stethoscope NURSES	23
SMITH-PETERSEN Bone Rongeur	238	Stethoscope PINARD	23
SMITH-PETERSEN Gouges	261	STEVENS Iris Tissue Forceps	383
SMITHWICK Applier Forceps	326	STEVENS Lens Hook	375
SMITHWICK Nerve Hook	328	STEVENS Needle Holder	214
Snare Wire	434, 468	STEVENS Ophthalmology Scissors	58
SNELLEN Cataract Loop	378	STEVENS Supercut Scissors	72
SNELLEN Entropium Forceps	393	STEVENSON Eye Specula	371
SOMER Uterine Grasping Forceps	585	STIEGLITZ Splinter Forceps	92
Spare Blade for HUMBY	50	STILLE Bone Hand Drills	298
Spare Blade for SCHINK	49	STILLE Chisels	260
Spatula	203, 612	STILLE Gouges	260
Spatula and Packer	612	STILLE Hemostatic Clamp	122
Specula FRIEDMANN	577	STILLE Plaster Scissors	229
Specula KALLMORGEN	573	STILLE Rib Scissors	480
Specula KRISTELLER	572	STILLE Tissue Forceps	81
Specula O'SULLIVAN-O'CONNOR	576	STILLE-BARRAYA Vascular Tissue Forceps	88
SPENCER Suture Scissors	66	STILLE-GIERTZ Rib Shears	481
SPENCER-WELLS Hemostatic Clamp	109	STILLE-HORSLEY Bone Cutting Forceps	242
Sphygmomanometer BABYPHON	10	STILLE-LISTON Bone Cutting Forceps	241
Sphygmomanometer DIPLOMAT	5	STILLE-LUER Bone Rongeur	239
Sphygmomanometer EXACTA	8	STILLE-RUSKIN Bone Rongeur	239
Sphygmomanometer MINIMUS	11, 12	STILLE-SHERMAN Bone Hand Drills	298
Sphygmomanometer NOVA	6, 7	STOCKMANN Penis Clamp	556
Sphygmomanometer PRECISA	9	Stomach Clamp LANE	547
SPINAL Bone Curettes	253	Stone Holding Clamp	545

**Index**  
**Indice**  
**Indice**

STONE-WATT Anastomosis Clamp	545	T	
Strabismus Forceps BONACCOLTO	385	TABB Knives	418
Strabismus Forceps DASTOOR	386	TAKAHASHI Nasal Forceps	427
Strabismus Forceps JAMESON	385	Tangential Clamp DEBAKEY-SATINSKY	502
Strabismus Forceps McCULLOUGH	385	TARNIER Cranioplast	607
Strabismus Hook GRAEFE	375	TARNIER Obstetrical Forceps	604
Strabismus Hook JAMESON	375	TAYLOR Percussion Hammer	24
Strabismus Scissors	56	TAYLOR Bone Retractor	291
STRANDELL-STILLE Retractor	157	TAYLOR Tissue Forceps	87
STRASSBURGER Tissue Forceps	89	TC Nasal Rasps	445
STRATTE Needle Holder	212	TC Needle Holders	208 to 217
STRAUSS Penis Clamp	556	TC Scissors	51 to 74
STRUEMPEL Foreign Body Forceps	412	TC Scissors FREEMAN	74
STRULLY Scissors	64	TC Scissors GORNEY	73
STRUYCKEN Nasal Forceps	427	TC Scissors KAYE	73
SUBRAMANIAN-MINIATURE Cardio Forceps	521	TC Scissors PECK-JOSEPH	74
Suction Handle WULLSTEIN	338	TC Scissors REES	73
Suction Irrigation Cannula	394	TC Scissors REYNOLDS	54
Suction Raspatory GUILLEN	433	TC Scissors STANDARD	51
Suction Tube ADSON	336	TC Tissue Forceps	81, 82
Suction Tube ANDREWS-PYNCHON	28	TC Tissue Forceps CUSHING	83
Suction Tube BABY-YANKAUER	27	TC Tissue Forceps GILLIES	86
Suction Tube BARON	336	TC Tissue Forceps SEMKEN	86
Suction Tube COOLEY	28	TC Tissue Forceps WANGENSTEEN	89
Suction Tube DASTOOR	380	TEALE Tenaculum	583
Suction Tube FRAZIER-FERGUSON	336	TEBBETTS Plastic Surgery Retractor	197
Suction Tube HOUSE	337	Tenaculum BARRETT	582
Suction Tube KLEINSASSER	36	Tenaculum BRAUN	582
Suction Tube PLESTER	338	Tenaculum CZERNY	584
Suction Tube POOLE	27	Tenaculum DUPLAY	582
Suction Tube ROSEN	338	Tenaculum HULKA	583
Suction Tube YANKAUER	27	Tenaculum IOWA	584
Suction Tube YASARGIL	337	Tenaculum JACOBS	583
Suction Tube ZOLLNER	337	Tenaculum JARCHO	583
Supercut Scissors BABY-METZENBAUM	71	Tenaculum MUSEUX	583
Supercut Scissors FREEMAN	74	Tenaculum PRATT	584
Supercut Scissors GORNEY	73	Tenaculum SCHRODER	583, 584
Supercut Scissors IRIS	72	Tenaculum SCHROEDER (BRAUN)	582
Supercut Scissors KAYE	73	Tenaculum SCHROEDER (POZZI)	582
Supercut Scissors KILNER	72	Tenaculum SKENE	582
Supercut Scissors LISTER	72	Tenaculum STAUDE-MOORE	582
Supercut Scissors MAYO	71	Tenaculum TEALE	583
Supercut Scissors MAYO-STILLE	71	Tendon Guide BUNELL	294
Supercut Scissors METZENBAUM	71	Tendon Holding Forceps STEINMANN	292
Supercut Scissors REES	73	Tendon Passing Instrument BRAND	294
Supercut Scissors REYNOLDS	72	Tendon Passing Instrument BUNNELL	292
Supercut Scissors STEVENS	72	Tendon Seizing Forceps	293
Supercut Scissors WAGNER	72	Tendon Seizing Forceps Jackson	292
Surgical Needle KEITH	223	Tendon Seizing Forceps LARSEN	292
Surgical Needle KOENIG	223	Tendon Seizing Instrument BRAND	293
Surgical Needles	222, 223	Tendon Seizing Instrument CAROLL	293
Surgical Scissors FERGUSON	66	Tendon Seizing Instrument KLEINERT-KUTZ	294
Surgical Scissors IRIS	54	TERSON Capsular Forceps	391
Surgical Scissors JOSEPH	54	TESSIER Retractor	463
Surgical Scissors KILNER	54	T-Handle	300, 301
Surgical Scissors METZENBAUM	51, 54	T-Handle HUDSON	300
Surgical Scissors REYNOLDS	54	THOMAS Uterine Curette	599
Surgical Scissors SANVENERO	54	THOMAS-GAYLOR Biopsy Forceps	588
Surgical Scissors SISTRUNK	66	THOMS-ALLIS Bowel Grasping Forceps	538
Surgical Scissors STANDARD	51	THOMSON-WALKER Bladder Retractors	552
Suture Scissors HEATH	66	Thoracic Spreader MERCEDES	489
Suture Scissors LITTAUER	66	THOREK Gall Bladder Scissors	65
Suture Scissors NORTHBENT	66	Three Prong Sterilization Forceps	227
Suture Scissors SHORTBENT	66	THUDICHUM Nasal Specula	421
Suture Scissors SPENCER	66	Thyroid Gland Hook SCHOENBORN	479
Suturing Set	225, 226	TIECK-HALLE Nasal Specula	423
SWEET Applier Forceps	326	TILLEY Ear Forceps	411
Swiss Type Cilia & Suture Forceps ANMUTH	395	Tip for Yankauer	27
		TISCHLER-DOWN Biopsy Forceps	591
		TISCHLER-KEVORKIAN Biopsy Forceps	592
		TISCHLER-MORGAN Biopsy Forceps	590, 591
		TISCHLER-UP Biopsy Forceps	591



**Index  
Indice  
Indice**

Tissue Forceps	90, 94	Tongue Forceps YOUNG	453
Tissue Forceps ADSON Micro	82	Tonometer SCHIOETZ	394
Tissue Forceps ADSON-BROWN	83	Tonsil Forceps ABRAHAM	468
Tissue Forceps ADSON-BROWN (OWEN)	96	Tonsil Elevator HENKE	465
Tissue Forceps Anatomic	81	Tonsil Elevator HURD	465
Tissue Forceps Bipolar	630 to 632	Tonsil Elevator LOPEZ-REINKE	465
Tissue Forceps BONNEY	88	Tonsil Elevator YANKAUER	465
Tissue Forceps BROPHY	84	Tonsil Forceps BALLENGER	467
Tissue Forceps BROWN	83	Tonsil Forceps BLOHMKE	467
Tissue Forceps CASTROVIEJO	392	Tonsil Forceps COLVER	467
Tissue Forceps CHAPUT	110	Tonsil Forceps MARSCHIK	468
Tissue Forceps COLLIN (Gall Bladder)	110	Tonsil Forceps NEGUS	467
Tissue Forceps COLLIN Grasping	110	Tonsil Forceps SAWTELL	467
Tissue Forceps CUSHING	83	Tonsil Forceps SCHNIDT	467
Tissue Forceps DEBAKEY	99	Tonsil Forceps TYDING	467
Tissue Forceps FERRIS-SMITH	84	Tonsil Forceps WHITE	467
Tissue Forceps GERALD	86, 87	Tonsil Knives ABRAHAM	466
Tissue Forceps GILLIES	86	Tonsil Knives BRUENINGS	466
Tissue Forceps GOMEL	96	Tonsil Knives CANFIELD	466
Tissue Forceps GRAEFE	83	Tonsil Knives CARPENTER	465
Tissue Forceps JEWELERS TYPE	90	Tonsil Knives DOUGLAS	466
Tissue Forceps LANE	84	Tonsil Knives FISHER	466
Tissue Forceps LERCHE	83	Tonsil Needle	470
Tissue Forceps MAYO	89	Tonsil Needle CLAUS	466
Tissue Forceps McPHERSON	392	Tonsil Needle DUPUY-WEISS	466
Tissue Forceps MOORFIELD	392	Tonsil Needle NAGER	466
Tissue Forceps OEHLER TC	81	Tonsil Needle TRELAT	466
Tissue Forceps PAUFIQUE	392	Tonsil Scissors BOETTCHER	59
Tissue Forceps POTTS-SMITH	81	Tonsil Scissors DEAN	59
Tissue Forceps PRATT T-Shape	110	Tonsil Scissors GOOD	59
Tissue Forceps RUSSIAN	85	Tonsil Scissors PRINCE	59
Tissue Forceps SEMKEN	86	Tonsil Snare BRUENINGS	468
Tissue Forceps SINGLEY	88	Tonsil Snare EVES	468
Tissue Forceps St. MARTIN	392	Tonsil Snare SLUDER-BALLENGER	470
Tissue Forceps STILLE	81	Tonsil Snare TYDING	469
Tissue Forceps STRASSBURGER	89	Tonsil Syringe	470
Tissue Forceps TAYLOR	87	Tonsil Wire	468
Tissue Forceps Type TUEBINGEN	392	TOOK Corneal Knife	373
Tissue Forceps Ultra Light	95	Tourniquet	295
Tissue Forceps USA Type	81	Tourniquet RUMEL-BELMONT	528
Tissue Forceps VICKERS	97	Towel Clamp BACKHAUS	132
Tissue Forceps WANGENSTEEN	89	Towel Clamp BACKHAUS-CLIP	132
Tissue Forceps WAUGH	83	Towel Clamp BALL and SOCKET	133
Tissue Forceps YASARGIL	98	Towel Clamp BERNHARD	133
Tissue Nipper	610	Towel Clamp DOYEN	133
Titan Atraumatic Bulldog Clamp	102	Towel Clamp JONES	132
Titan Clips	549	Towel Clamp JONES-CLIP	132
Titan Hemostatic Clamp CRILE	107	Towel Clamp LANE	133
Titan Hemostatic Clamp KELLY	106	Towel Clamp LORNA	133
Titan Tissue Forceps DEBAKEY	99	Towel Clamp MOYNIHAN	133
TOBOLD Cotton Applicator	203	Towel Clamp PEERS	132
TOBOLD Tongue Depressors	453	Towel Clamp ROEDER	132
TOENNIS Dura Dissector	332	Towel Clamp SCHAEDEL	132
TOENNIS Hemostatic Clamp	117	Towel Clamp TOHOKU	132
TOENNIS-ADSON Scissors	64	TOWNSEND MINI Biopsy Forceps	591
TOHUKU Towel Clamp	132	TOYNBEE Ear Specula	399
Tongue Depressors ANDREW	452	Trachea Cannula CHEVALIER-JACKSON	479
Tongue Depressors BRUENINGS	451	Trachea Cannula LUER	479
Tongue Depressors BUCHWALD	451	Trachea Cannula WAGENER-MOSHER	477
Tongue Depressors DAVIS-BOYLE	455	Trachea Dilator LABORDE	476
Tongue Depressors DINGMAN	456	Trachea Dilator TROUSSEAU	476
Tongue Depressors FRENZEL	451	Trachea Dilator TROUSSEAU-BABY	476
Tongue Depressors HARTMAN	452	Trachea Hook BOSE	476, 477
Tongue Depressors KILNER-DOUGHTY	456	Trachea Hook ITERSON	477
Tongue Depressors KROENIG	451	Trachea Hook JACKSON	476
Tongue Depressors MAYO	451	Trachea Hook NEWS	477
Tongue Depressors MORITZ-SCHMIDT	452	Tracheotomy Hooks and Knives	475
Tongue Depressors RING	455	Tracheotomy Set	478
Tongue Depressors RUSSEL-DAVIS	458	Trachoma Forceps KNAPP-LUER	393
Tongue Depressors TOBOLD	453	Transfer Jar	615
Tongue Depressors WIEDER	452	TRAVERS Retractor	172
Tongue Forceps COLLIN	453	Tray SCHIMMELBUSCH	622

**Index**  
**Indice**  
**Indice**

Tray, Bowls	619	Uterine Dilator HEGAR	578, 579
TRELAT Tonsil Needle	466	Uterine Dilator PRATT	580
TRELAT Vaginal Specula	571	Uterine Dilator SIMS	581
Trocar COAKLEY	204	Uterine Dilator WYLIE	581
Trocar DOUGLAS	204	Uterine Forceps GREEN-ARMYTAGE	605
Trocar LICHTWITZ	204	Uterine Grasping Forceps COLLIN	585
Trocar NELSON	205	Uterine Grasping Forceps DARTIGUES	585
Trocar OCHSNER	205	Uterine Grasping Forceps SOMER	585
Trocar PIERCE	204	Uterine Polyp Forceps DOYEN	585
Trocar STANDARD (NELSON)	204	Uterine Polyp Forceps KELLY	585
Trocar UNIVERSAL	204	Uterine Polyp Forceps NOTO	585
TROELTSCH Ear Forceps	424	Uterine Sounds/Probes COLLIN	586
TROEMNER Percussion Hammer	24	Uterine Sounds/Probes SIMPSON	586
TROUSSEAU Trachea Dilator	476	Uterine Sounds/Probes SIMS	586
TROUSSEAU-BABY Trachea Dilator	476		
TROUTMAN Iris Tissue Forceps	384, 389	V	
TROUTMAN-CHRIS Bladebreaker	45	Vacuum for Plaster Cast Saw	231
TUBBS Aortic Dilator	528	Vaginal Specula	569
Tube Holder	188	Vaginal Specula JACKSON	573
Tubing Clamp HOFFMANN	624	Vaginal Specula AUVARD	576
Tubing Clamp SIMPLEX	624	Vaginal Specula BREISKY	577
Tubing Clamps	129	Vaginal Specula COLLIN	570
TÜBINGEN Eye Cannula	394	Vaginal Specula CUSCO	570, 571
TÜBINGEN Tissue Forceps	392	Vaginal Specula DOYEN	574
TUFFIER Retractor	147	Vaginal Specula GRAVES	570
TUFFIER Rib Spreader	487	Vaginal Specula KRISTELLER	572
TUFFIER Tissue Grasping Forceps	110	Vaginal Specula LANDAU	577
Tumor Grasping Forceps LANDHOLT	341	Vaginal Specula PEDERSON	570
Tumor Tissue Forceps YASARGIL	98	Vaginal Specula SCHERBAK	575
Tuning Fork	404	Vaginal Specula SEMM	571
Tuning Fork ANMUTH	403	Vaginal Specula SIMS	573
Tuning Fork HARTMAN	403	Vaginal Specula TRELAT	571
Tuning Fork LUCAE	404	Vaginal Specula VU-MORE	569
Tuning Fork RYDEL-SEIFFERT	404	VALLEIX Probes	586
TURNBULL Nail Forceps	609	VAMMI Chisel	264
TURREL Rectal Biopsy Forceps	567	VAMMI Hammer	271
TYDING Tonsil Forceps	467	VAN BUREN Bone Holding Forceps	249
TYDING Tonsil Snare	469	VAN BUREN Dilation Bougie	554
		VANNAS Eye Scissors	79
U		VARADY Varix Instrument	202
UCKERMANN Cotton Applicator	203	Varicose Vein Probes NABATOFF	201
ULRICH Bone Holding Forceps	248	Varix Instrument VARADY	202
ULRICH Dressing Forceps	135	Vascular Cannula SCHMID	338
Ultra Light Tissue Forceps Atraumatic	95	Vascular Clamp DEBAKEY	493 to 500, 507, 514 to 517
Umbilical Clamp COLLIN	605	Vascular Clamp DEBAKEY Childrens	516
Umbilical Clamp KANE	605	Vascular Clamp BAINBRIDGE	495
Umbilical Scissors BUSCH	64	Vascular Clamp BECK	516
Umbilical Scissors SCHUMACHER	64	Vascular Clamp COOLEY	518, 522
Umbilical Scissors USA Type	64	Vascular Clamp DIEFFENBACH	104
UNI I Otoloscope	13	Vascular Clamp GLOVER	515
UNI III Diagnostic Set	15	Vascular Clamp SATINSKY	491
UNIVERSAL Bandage Scissors	70	Vascular Clamp POTTS	493
Universal Handle HUBER	472	Vascular Clip BIEMER	361
UNIVERSAL Sterilization Forceps	227	Vascular Clip MEHDORN	362
UNIVERSAL Trocar	204	Vascular Clip MUELLER	365
UNIVERSAL Wire Scissors	67	Vascular Dilator DEBAKEY	529
UNNA Comedone Extractor	608	Vascular Dissector ROBB	530
Urethrotome OTIS	553	Vascular Scissors DEBAKEY	61
US ARMY Retractor	141	Vascular Scissors DEBAKEY TC	60
USA Tissue Forceps	81	Vascular Scissors DIETHRICH	60
Uterine Curette BLAKE	595	Vascular Scissors FAVALORO	61
Uterine Curette BUMM	597, 598	Vascular Scissors KELLY	61
Uterine Curette GOURDET	599	Vascular Scissors KLINKENBERG-LOTH	65
Uterine Curette RECAMIER	597, 599	Vascular Scissors POTTS-DE MARTEL	59
Uterine Curette SCHROEDER	595	Vascular Scissors POTTS-SMITH	61
Uterine Curette SIMON	594	Vascular Scissors SATINSKY	65
Uterine Curette SIMS	597, 600	Vascular Tissue Forceps ADLERKREUTZ	84
Uterine Curette THOMAS	599	Vascular Tissue Forceps NELSON	88
Uterine Depressor BRAUN	586	Vascular Tissue Forceps STILLE-BARRAYA	88
Uterine Depressor SIMS	586	Vascular Tissue Forceps WANGENSTEEN	89
Uterine Dilator GOODSELL	581	Vasectomy Clamp No Scalpel	557
Uterine Dilator HANK	580	VERBRUGGE Bone Holding Forceps	245

**Index**  
**Indice**  
**Indice**

VERBRUGGE-MUELLER Bone Levers	287	WILLIGER Curette	255, 257
VERESS Insufflation Cannula	206	WILLIGER Hammer	271
VICKERS Micro Tissue Forceps	97	WILLIGER Raspatory	276
VIENNA Ligature Guide Probe	221	WINTER Ovum Forceps	606
VIRCHOW POST MORTEM Knives	48	Wire Cutting Bone Pliers	317
VIRTUS (RALK) Splinter Forceps	92	Wire Gauze	311
VOLKMANN Bone Curettes	251	Wire Grasping Forceps	318
VOLKMANN Bone Curettes D/E	257	Wire Guide Needle DEMEL	315
VOLKMANN Retractor	153, 154	Wire Instrument DEMEL	315
VOLTOLINI Nasal Specula	421	Wire Instrument LOUTE	315
VON PETZ Stomach and Bowel Suturing Apparatus	549	Wire Saw OLIVECRONA	332
VU-MORE Vaginal Specula	569	Wire Scissors UNIVERSAL	67
W		Wire Twist Forceps BERRY TC	319
WACHENFELDT Clip Tissue Forceps	224	Wire Twist Forceps CORWIN-HEGAR TC	319
WADSWORTH-TODD Cautery	378	Wire Twist Forceps MAYO-HABERISSER TC	319
WAGENER Hook	409	WITTNER Biopsy Forceps	589
WAGENER-MOSHER Trachea Cannula	477	WOLFF Plaster Forceps	233
WAGNER Laminectomy Rongeurs	343	WOODSON Dura Dissector	333
WAGNER Scissors	67	Wound Curette ARRUGA	378
WAGNER Supercut Scissors	72	WRIGLEY Obstetrical Forceps	602
WALDMANN Episiotomy Scissors	64	WULLSTEIN Knives	418
WALLICH Ovum Curette	607	WULLSTEIN Micro Cannula	338
WALSHAM Septum Straightening Forceps	449	WULLSTEIN Micro Ear Forceps	416
WALTER Splinter Forceps	91	WULLSTEIN Retractors	171
WALTON Foreign Body Gouges	374	WULLSTEIN Suction Handle	338
WALTON Comedone Extractor	608	WYLIE Uterine Dilator	581
WALTON Finger Ring Saw	297	Y	
WANGENSTEEN Needle Holder	210	YANCOSKIE Retractor	198
WANGENSTEEN Vascular Tissue Forceps	89	YANKAUER Suction Tube	27
WARTENBERG Pinwheel	25	YANKAUER Tonsil Disector	465
Water Jet Pistol and Parts	626	YASARGIL Aneurysm Clip	349 to 356
WATSON Dermatome	50	YASARGIL Galea Hook	330
WATSON-CHEYNE Elevator	283	YASARGIL Suction Tube	337
WATSON-CHEYNE Probes	199	YASARGIL Tumor Tissue Forceps	98
WATSON-WILLIAMS Nasal Forceps	428	YEOMAN Rectal Biopsy Forceps	566, 567
WAUGH Tissue Forceps	83	YOUNG BOOMERANG Suture Instrument	220
WEBER Blood Vessel Clamp	501	YOUNG Prostatic Hook	550
WEBER Cataract Loop	378	YOUNG Tongue Forceps	453
WEBSTER Needle Holder	208	Z	
WECKER Iris Spatula	378	ZAUFAL Ear Hook	409
WEEK Eye Specula	370	ZAUFAL-JANSEN Bone Rongeur	238
WEIL-BLAKESLEY Nasal Forceps	426	ZAUFAL-JANSEN Ear Hook	409
WEITLANER Retractors	169	ZENKER Hemostatic Clamp	118
WEITLANER-WULLSTEIN Retractors	169	ZENKER Retractor	161
WELLS Enucleation Curette	378	ZIEGLER Dissection Knives	373
WERTHEIM Gynecological Scissors	62	ZIEGLER Eye Specula	371
WERTHEIM Hysterectomy Clamp	124, 128	ZIEGLER Head Mirrors	21
WERTHEIM Hysterectomy Scissors	63	ZIEGLER Iris Knives	372
WERTHEIM-CULLEN Hysterectomy Clamp	125	ZIEGLER Lacrimal Dilator	381
WEST Nasal Chisels	442	ZIELKE Gouges	264
WESTCOTT Eye Scissors	75	ZOLLNER Suction Tube	337
WESTMACOTT Nasal Dressing Forceps	424		
WESTON Rectal Snare	566		
WHEELER Cycloidalysis Spatula	379		
WHEELER Dissection Knives	373		
WHITE Tonsil Forceps	467		
WIBERG Raspatory	277		
WIEDER Tongue Depressors	452		
WIENER Antrum Rasp	443		
WIENER Iris Hook	375		
WIGMORE Plaster Knives	229		
WIKSTROEM Hemostatic Clamp	117		
WILDE (TROELTSCH) Ear Forceps	410, 424		
WILDE Ear Polyp Snare	411		
WILDE Nasal Polyp Snare	434		
WILDER Cataract Loop	378		
WILDER Lacrimal Dilator	381		
WILLET-MARTEL Grasping Forceps	110		
WILLIAMS Bowel Grasping Forceps	539		
WILLIAMS Eye Specula	370		
WILLIAMS Screw Driver	323		



Office Address: Qudoos Street, Shahab Pura, Defence Road, Sialkot 51310 - Pakistan

Factory Address: Capital Road, Jinnah Town, Pacca Garha, Sialkot 51310 - Pakistan

Ph#: +92-52-4270515 / 3553008

Fax: +92-52-4270516

Email: [info@bootnasinstruments.com](mailto:info@bootnasinstruments.com)

Web: [www.bootnasinstruments.com](http://www.bootnasinstruments.com)



**BOOTNAS INSTRUMENTS**